

CP Electronics

A brand of **legrand**

Lighting Control

Sensors for
efficient and smart
lighting control



Technical guide 2025

A brand of **legrand**

Lighting control

CP Electronics' products are the ideal solution for smart lighting management.

Thanks to three different technological offerings:

- 1 - Stand Alone Sensors
- 2 - Casambi
- 3 - KNX

Energy Efficiency in Buildings



The products of this catalogue form part of a wide range of devices to enable energy efficiency in buildings: a structured and holistic approach to reducing the environmental impact and increasing sustainability of businesses.



CP Electronics
A brand of **legrand**

ENERGY CONTROLS



CP Electronics is a British company of the Legrand group specialising in smart lighting control products.



Contents

General features

4

Who is CP Electronics	4
Why choose the Lighting Control solution?	6
Sensor families	8
Sensor overview	10

Technical features

12

Guide for sensor features	12
Selection guide - Stand Alone Sensors	18
Selection guide - CASAMBI Sensors	40
Selection guide - KNX Sensors	50

Applications

58

Catalogue

83

Who is CP Electronics

CP Electronics is a British company specialising in the production of lighting control products that's been part of the Legrand group since 2016:

- CP Electronics is the largest manufacturer of lighting control systems in the UK.
- It has over 50 years of experience in lighting control.
- In-house research and development, production and distribution at CP Electronics.
- Products range from simple on-off sensors to sophisticated microwave (MW) presence sensors and fully addressable lighting control systems.

A brand of **legrand**



CP Electronics
a leading force
in lighting
controls



CP Electronics offers a wide range of products with:

- Cost-effective solutions
- High detection performance, even of the smallest movements
- Perfect control of any type of light source
- 5-year warranty for all the products



For all the sensors



The use of CP Electronics sensors allows to save up to 45% of energy only for light management, according to standard EN15193. By also integrating HVAC temperature control systems, further savings are possible.

Controlling lighting with a presence detector can save up to 45% of lighting energy usage dependent on occupancy behaviour and the amount of natural light available. Selected PIR and microwave presence detectors can also be used to control heating and ventilation.

CP Electronics' specialised offer makes it possible to find the best presence sensor for any space and requirement.

Why choose the Lighting Control solution?

CP Electronics Lighting Control solution allows to:

have products suitable for several applications, which can solve any lighting issues while saving energy.

1

Energy savings

Eliminate energy waste by only switching on the lights when necessary. Take advantage of HVAC integration.



4

Building evaluation

Contribute to ensure compliance with energy labels (BREAM, LEED).



2

Comfort

Ensure the right level of illumination in all conditions.



3

Visual safety

Eliminate any risks associated with poorly lit areas, ensuring safety at all times.



5

Regulatory Obligations

Regulatory and legislative obligations for energy efficiency in residential and non-residential buildings.





Sensors families

CP Electronics introduces a wide range of specialist sensors suitable for every type of environment and application.

Our wide range of **passive infrared (PIR)** and **microwave (MW) presence/absence detectors** are designed to reduce the amount of time lighting is left on unnecessarily, for example if an area is unoccupied or if there is sufficient natural light.

CP Electronics
A brand of **legrand**



Wide choice of sensors for:

- Type of installation (false ceiling, surface, high ceilings and bays, channels)
- All the loads (ON-OFF, DALI Digital Dimmer, 1-10V Analog Dimmer)
- Type of application (workplaces, passageways, warehouses, car parks...)
- Stand alone and standard systems (Casambi-KNX)

Can be configured to adapt to any user need in terms of energy saving and comfort.

Warranty extended to 5 years for all the CP Electronics sensors.

CP Electronics

A brand of 

PIR (Passive Infrared) presence sensors



EBDSPIR

Compact PIR sensors, ceiling flush mounting



EBDSM

Compact PIR sensors, ceiling surface mounting



EBDMR

Compact PIR sensors, ceiling flush mounting, mid range.



EBMHS

Miniature PIR sensors, ceiling flush mounting



EBMPIR-MB

Miniature PIR sensors, luminaire mounting



EBDRC

PIR sensors, ceiling flush mounting, long range for corridors, with swivel head



EBDHS

PIR sensors, flush mounting for very high rooms (high bay)



EBDHS-MB

PIR sensors, luminaire mounting for very high rooms (high bay)

MW (Micro Wave) presence sensors



MWS3A

MW sensors, ceiling flush mounting, long range for corridors, with swivel head



MWS5

Compact MW sensors, ceiling surface/flush mounting



MWS6

Compact MW sensors, with low profile, ceiling flush mounting



MWS6SM

Compact MW sensors, ceiling surface mounting



MWS1A

Square MW sensors, long range, wall semi-protruding mounting



MWS1A-IP

Square MW sensors, long range, wall surface mounting, IP66



MWS1A-C

Square MW sensors, ceiling semi-protruding mounting (ceiling lights)

















MWS1A-C-IP

Compact MW sensors, ceiling surface mounting (ceiling lights), IP66

Overview of sensor families

STAND ALONE

Ceiling PIR	False ceiling	Surface	Mid range
			
	EBDSPIR Compact PIR sensors, ceiling flush mounting	EBDSM Compact PIR sensors, ceiling surface mounting	EBDMR Compact PIR sensors, ceiling flush mounting, mid range.
	Corridors	Mini (small-sized)	Batten installation
			
	EBDRC PIR sensors, ceiling flush mounting long range for corridors, with swivel head	EBMHS Miniature PIR sensors, ceiling flush mounting	EBMPIR-MB Miniature PIR sensors, luminaire mounting
Microwave wall and ceiling	Corridors	Mini (small-sized)	False ceiling
			
	MWS3A MW sensors, ceiling flush mounting, long range for corridors, with swivel head	MWS5 Compact MW sensors, ceiling surface/flush mounting	MWS6 Compact MW sensors, with low profile, ceiling flush mounting
	Semi-protruding mounting (for high ceilings) IP40	Surface mounting (for high ceilings) IP66	Semi-protruding mounting IP40
			
	MWS1A Square MW sensors, long range, wall semi-protruding mounting	MWS1A-IP Square MW sensors, long range, wall surface mounting, IP66	MWS1A-C Square MW sensors, ceiling semi-protruding mounting (ceiling lights)
High ceiling or high bay	Surface mounting	Low working temperatures	Batten installation
			
	EBDHS PIR sensors, flush mounting for very high rooms (high bay)	EBDHS-LT30 Compact MW sensors, ceiling surface/flush mounting	EBDHS-MB PIR sensors, luminaire mounting for very high rooms (high bay)

False ceiling RAL 9005



False ceiling RAL 9005



CASAMBI

False ceiling



EBDSPIR-CB-DD
Compact PIR sensors,
ceiling flush mounting

False ceiling



EBDMR-CB-DD
Compact PIR sensors,
ceiling surface mounting. Mid range

KNX®

False ceiling



EBDSPIR-KNX
Compact PIR sensors,
ceiling flush mounting



EBDSPIR-KNX-MR
Compact PIR sensors,
ceiling flush mounting

False ceiling

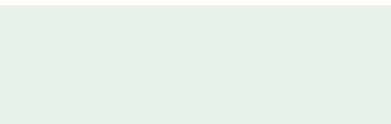

Ceiling surface mounting IP66



MWS1A-C-IP
Compact MW sensors,
ceiling surface mounting
(ceiling lights), IP66



EBMHS
Miniature PIR sensors,
ceiling flush mounting

Batten Mount
for very high installations (high bay)



EBDHS-MB-CB-DD
PIR sensors, flush mounting
for very high rooms (high bay)

False ceiling



MWS3A-KNX
MW sensors, ceiling flush mounting,
long range for corridors, with swivel head

False ceiling



MWS6-KNX
Compact MW sensors, with low profile,
ceiling flush mounting

False ceiling

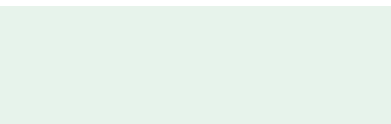

False ceiling



EBDHS-B-CB-DD
PIR sensors, flush mounting
for very high rooms (high bay)

False ceiling



EBDHS-KNX
PIR sensors, luminaire mounting for very
high rooms (high bay)

Guide for sensor features

The following section explains and illustrates some differences in the operation of the sensors, in the hope of making the selection by the user simpler, so that the best sensor may be chosen for the specific application.

Difference between “PRESENCE” and “ABSENCE” functions

The choice between presence and absence detection can make a big difference in user-friendliness and the amount of energy saved.

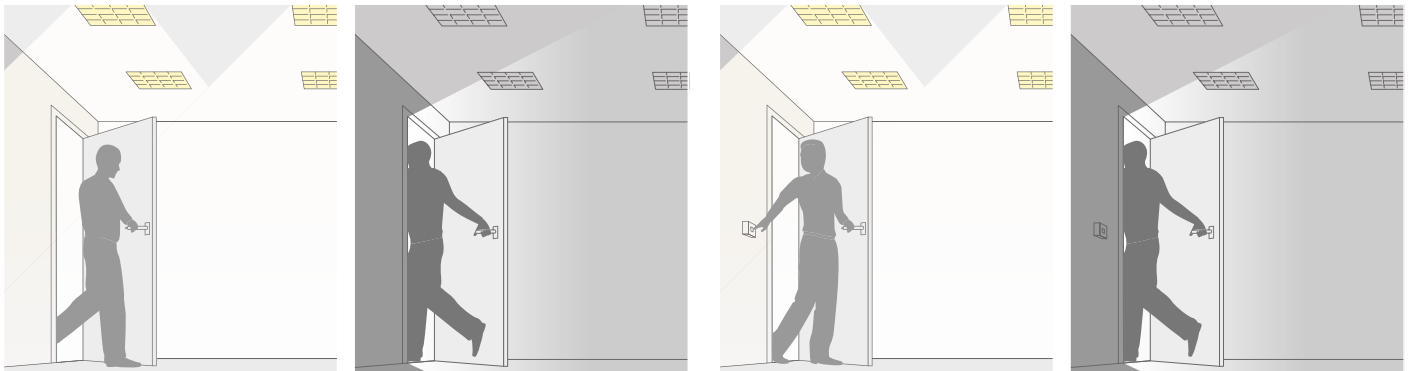

PRESENCE DETECTION: Sensors will switch on lighting automatically when a person enters the room, and switches off lighting automatically when no movement is detected.

ABSENCE DETECTION: Upon entering the room the person switches on the light using a pushbutton, but on leaving the sensor switches off the lighting automatically. Lights can also be switched off manually.

Parameters of the absence function

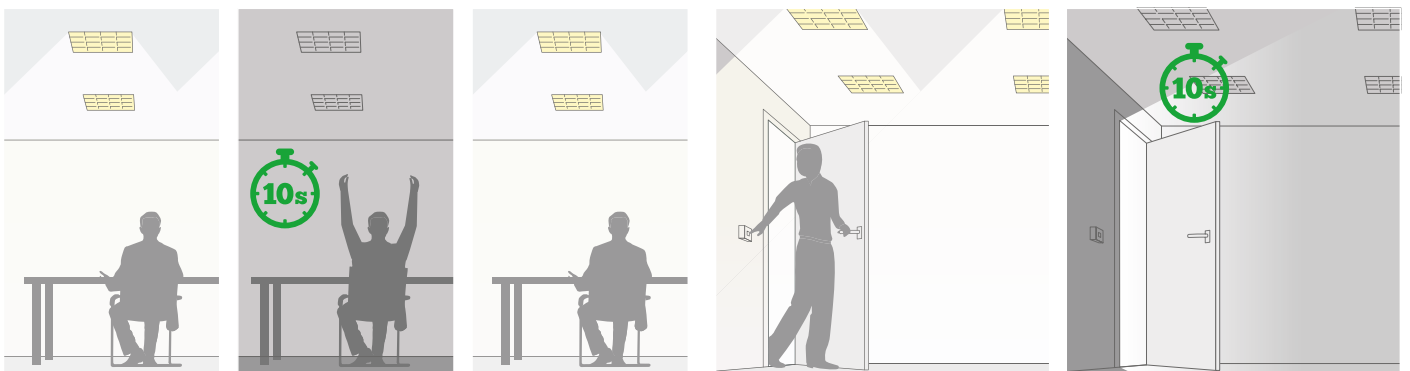

ABSENCE RECOVERY: After an occupancy time out period has elapsed in absence mode, the unit temporarily enters a presence mode for 10 seconds allowing the occupants movement to bring the lights back on.

SWITCH DETECTION TIME: This ensures that if a switch is activated and no movement is detected the lights will switch off after 10 seconds, minimising unnecessary lit space.

PIR and microwave sensors compared

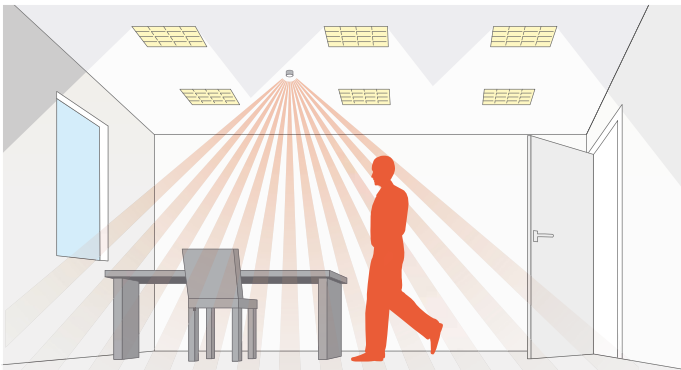

PIR (PASSIVE INFRARED) SENSORS: PIR sensors work on detecting the movement of body heat. They are better suited to smaller spaces or where a defined detection pattern is required.

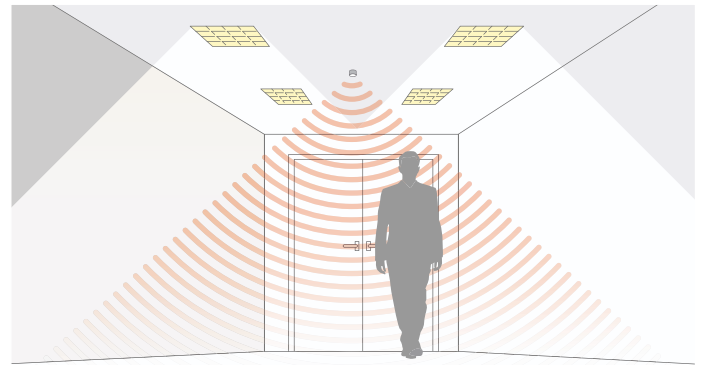

MICROWAVE SENSORS: microwave sensors work by detecting even small movements of objects and people in the room, with high sensitivity levels and wide coverage diameter. They can detect through glass and low density surfaces such as wood and plasterboard, therefore careful consideration on location is needed in certain applications.

Frontal and transversal approach (PIR sensors)



WALK TOWARDS: the detection of a PIR sensor may be less reactive in this direction, as it is possible to move towards the detector without a transversal movement (which is required for detection).



WALK ACROSS: the detection area of a PIR sensor results in a rapid detection because multiple sectors are crossed quickly triggering the sensor.

Guide for sensor features

The following section explains and illustrates some differences in the operation of the sensors, in the hope of making the selection by the user simpler, so that the best sensor may be chosen for the specific application.

ON-OFF sensors

Switching on by means of presence detection and minimum level sensing (in lux)

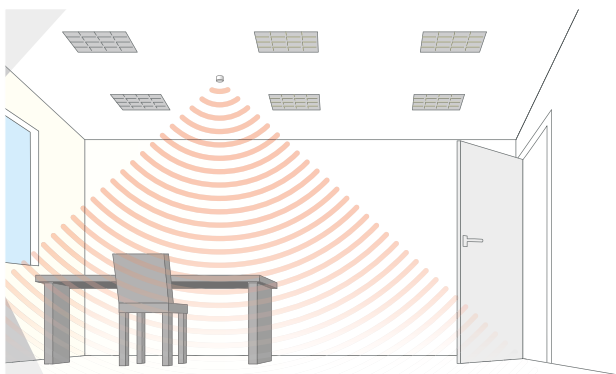

1 No presence detected, daylight, lights off.

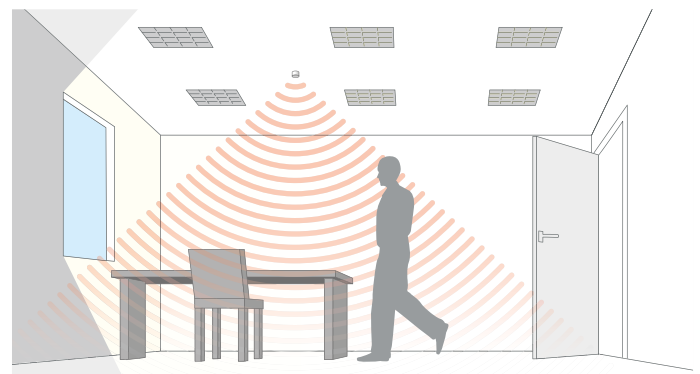

2 Presence detected, sufficient daylight, lights off.

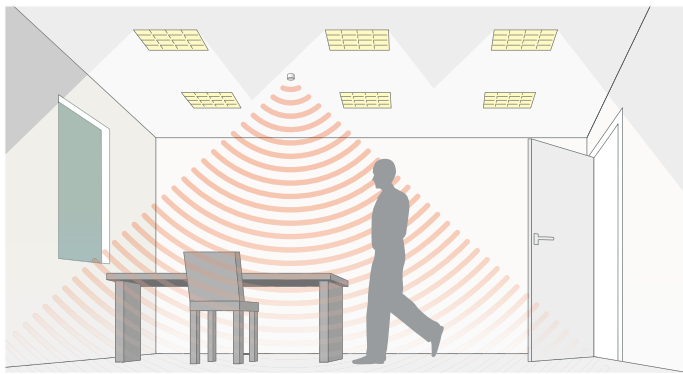

3 Presence detected, insufficient daylight, all lights on.

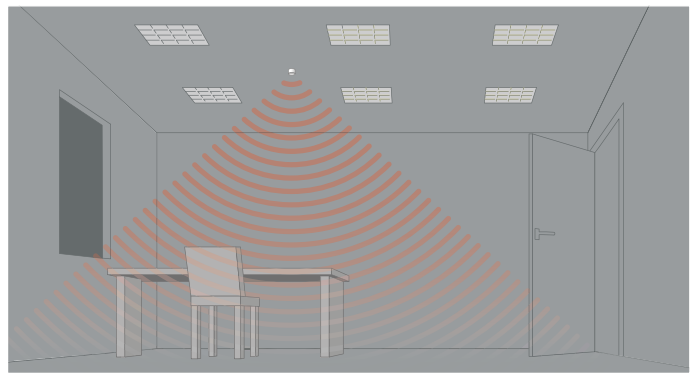

4 No presence detected, insufficient daylight, lights off.

Key features

- Switching on by means of presence detection and minimum level sensing (in lux)
- Delay time function
- Presence detection switching
- Absence detection switching
- Programmable via configuration Gateway and SmartBeam app
- Adjustable detection sensitivity
- On/off override via optional Infrared handset
- Manual on/off override via switch input.

DALI broadcast and 1-10 V sensors

Switching on by means of presence detection and maintaining the desired level sensing (in lux)

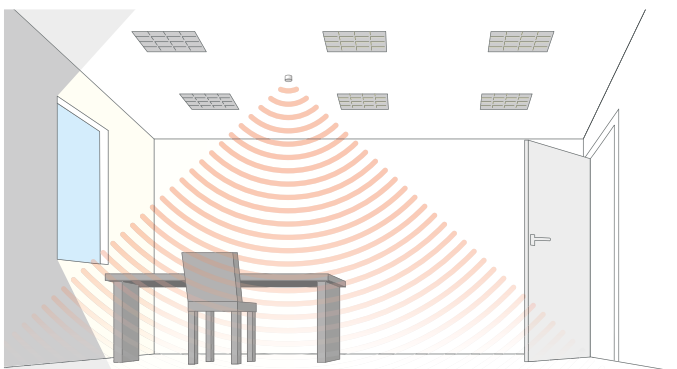

1 No presence detected, lights off.

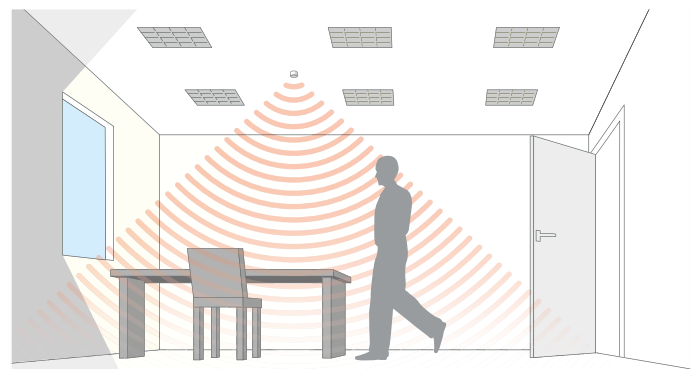

2 Presence detected, sufficient daylight, lights off.

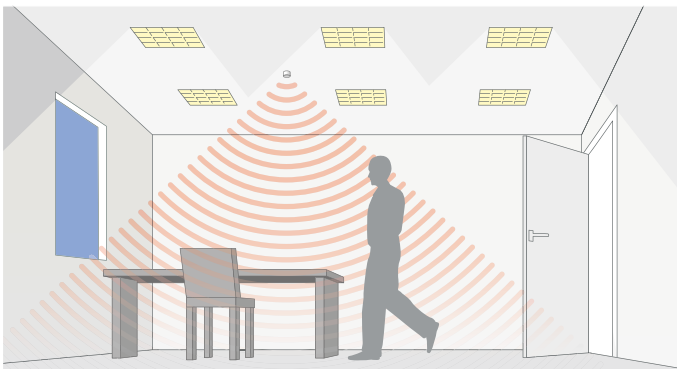

3 Presence detected, insufficient daylight, lights on and dimmed to maintain lux level depending on the level of natural light.

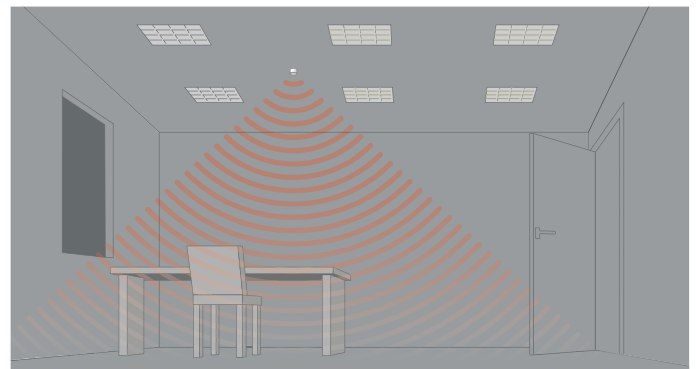

4 No presence detected, insufficient daylight, lights off.

Key features (in addition to ON-OFF sensors)





- Dimming functionality
- Independence of the ON/OFF channel and of the dimming channel
- Maintained illuminance (daylight harvesting)
- Scene setting and recall
- Burn-in feature for fluorescent tubes
- Control of DALI broadcast and 1-10V loads depending on product
- Integral relay to reduce ballast stand-by consumption
- Suitable for all lighting types
- Manual dimming with infrared
- Manual dimming with switch inputs for traditional pushbutton

Configuration software and parameter modification APP

The table below summarises which configuration software and which APPs should be used when putting the sensor into service:

- Stand Alone
- Casambi
- KNX



System-Product	Mean of communication	Product-System configuration	Modification of sensor parameters
STAND ALONE	Infrared (IR)*	CLOSE -UP APP 	CLOSE -UP APP 
CASAMBI	Bluetooth LE 4.0	"CASAMBI" APP 	"CASAMBI" APP 
KNX	Wired BUS KNX – TP2	ETS4 software or higher version	ETS4 software or higher version



CASAMBI APP



CLOSE -UP APP



* Accessory needed: Configuration gateway item 088240

The APPs are compatible with Android and Apple and can be downloaded from the related stores

Guide for sensor selection

The offer of presence sensors is wide and comprehensive, with a sensor being available for each type of application.

The wide range of **STAND ALONE** sensors is complemented by communication devices and technologies-protocols such as **CASAMBI** and **KNX**.

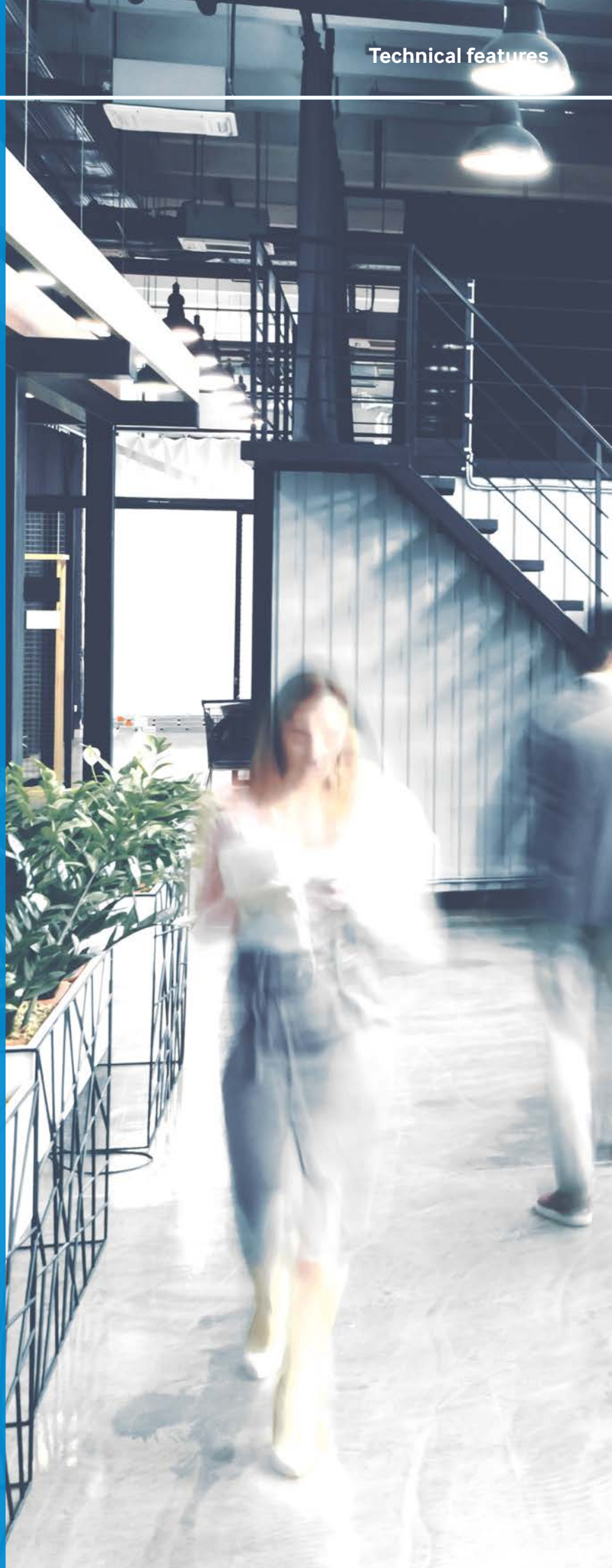

STAND ALONE sensors

PIR and MW sensors suitable for all types of settings.

The range of stand alone PIR detectors and microwave presence detectors is designed to reduce the amount of time lighting is left on unnecessarily, for example if an area is unoccupied or if there is sufficient natural light.

Controlling lighting with a presence detector can **save up to 45% of energy only for light management, according to standard EN15193. By also integrating HVAC temperature control systems, further savings are possible.**

A presence sensor monitors the detection zone for occupancy; if a person is sensed then the sensor will automatically turn the lighting on.

When the area is vacated, the lighting will turn off after a preset time delay.

All the PIR sensors and microwave sensors have a built in light level (LUX) sensor which will keep the lighting off if there is enough natural light available.



The Close-UP App is used together with the Configuration Gateway to change the parameters of the sensors.

- Mean of communication:

Infrared (IR)*

- Product and system configuration:

"Close UP" app

- Modification of sensor parameters:

"Close UP" app

Stand alone sensor suitability

Main features

- Room by room lighting control
- Presence or absence detection
- LUX level sensing
- Switching or dimming
- Single circuit control.

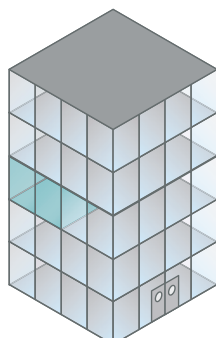

Stand alone detectors are best suited to controlling lighting in a single room or area, e.g. an office or corridor.

In larger spaces multiple detectors can be employed to ensure that the entire area is covered.

Typical wiring diagram of the STAND ALONE - ON-OFF sensor

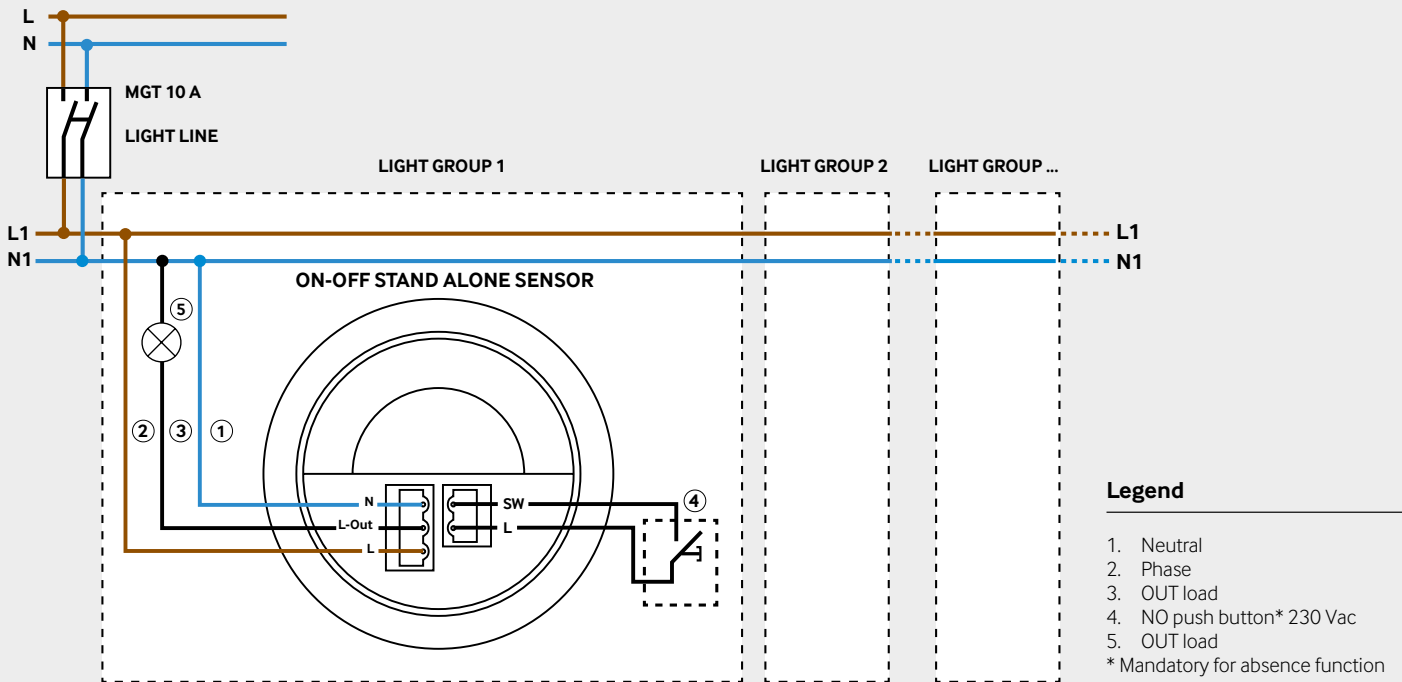

Typical wiring diagram of the STAND ALONE - DALI sensor

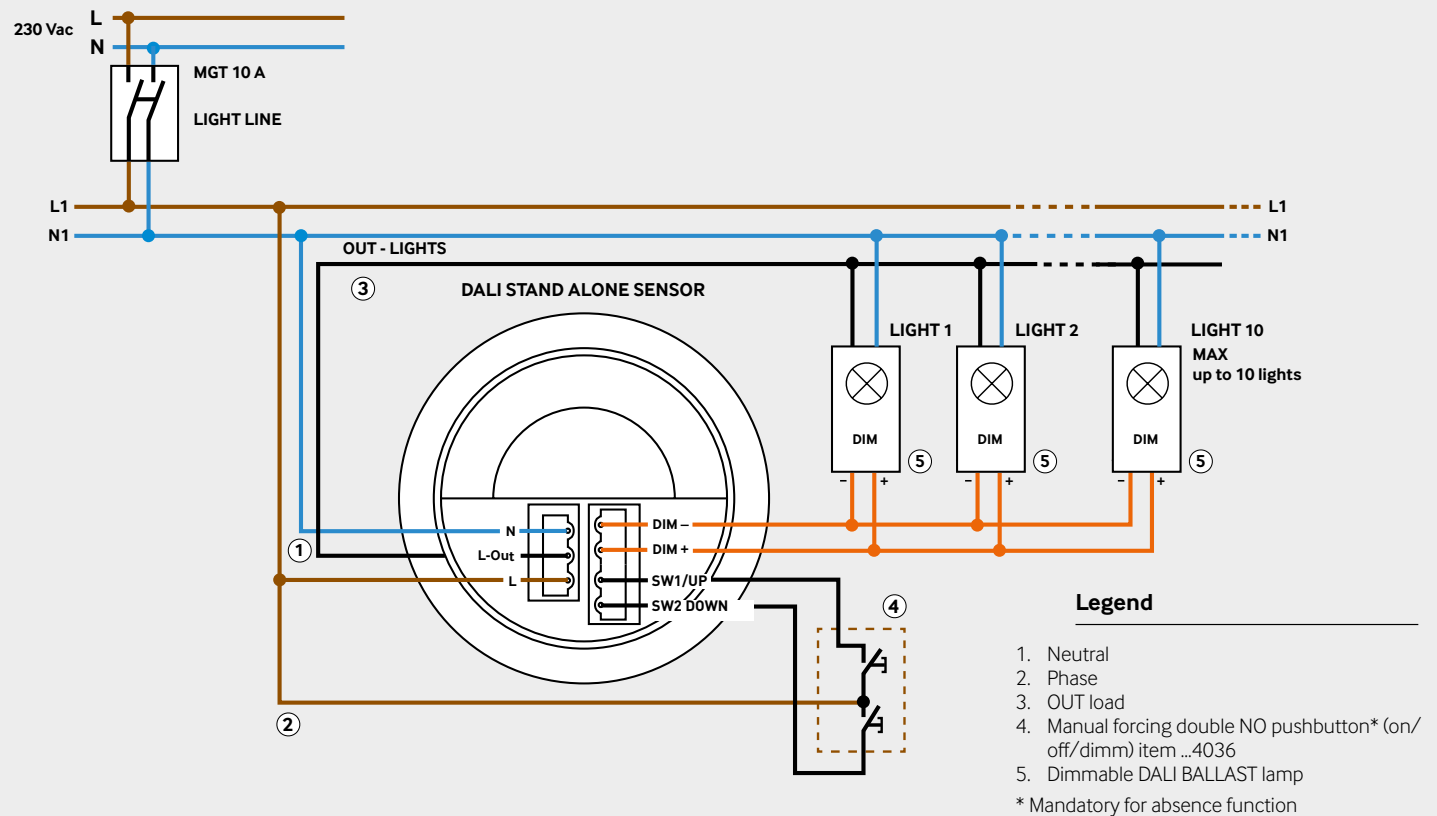

Guide for sensor selection - STAND ALONE

EBDSPIR | Compact PIR sensors, ceiling flush mounting.



This compact ceiling mounted presence sensor provides automatic control of lighting, heating and ventilation loads.

- Low profile design
- Self contained unit
- Programmable : switching off time, brightness level (in lux) and other parameters using the configuration Gateway and the SmartBeam app
- IP40 rated
- 5-year warranty.

Detection pattern

high < sensitivity > low

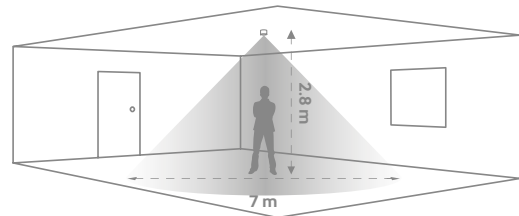

Orderable sensor variants

Item	CEILING FLUSH MOUNTING
	EBDSPIR series Flat PIR sensors for ceiling mounting. Detection 360°, range ø 7 m with recommended fixing height: 2.8 m. IP 40
CP130038	ON/OFF 10 A
CP130039	ON/OFF 6 A 2 outputs
CP130042	ON/OFF 6 A 2 NC outputs (Fail Safe)
CP130045	ON/OFF 10 A IP 55
CP130046	ON/OFF 10 A IP 55 -30 °C
CP130048	ON/OFF 3 A 12-24 V AC/DC
CP130052	ON/OFF 3 A 1 x NA/NC
CP130005	1-10 V 10 A analog dimmer
CP130007	1-10 V 10 A IP 55 -30 °C analog dimmer
CP130018	DALI 10 A digital dimmer
CP130021	DALI 10 A IP 55 -30 °C digital dimmer
CP130022	DALI 3 A 12-24 V AC/DC digital dimmer

Dimensions (mm)

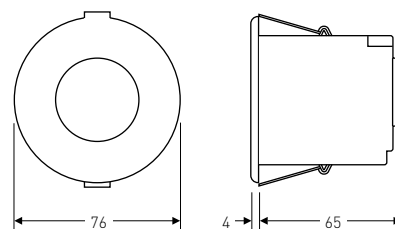

Legrand Code

EBDSM | Compact PIR sensors, ceiling surface mounting.



This series of surface mounted PIR presence/absence sensors is perfect for simple installation when flush mounting is not possible.

- Self contained unit
- Easy to install via a back plate
- Programmable : switching off time, brightness level (in lux) and other parameters using the configuration Gateway and the SmartBeam app.
- IP40 (no gasket); IP54 when fitted with gasket
- 5-year warranty.

Orderable sensor variants

Item	SURFACE MOUNTING
Legrand Code	EBDSM PIR sensors for ceiling mounting. 360° detection. range \varnothing 7 m. Recommended fixing height: 2.8 m IP 40 / IP 54
	CP120002 ON/OFF 10 A
	CP120000 1-10 V 10 A analog dimmer
	CP120001 DALI 10 A digital dimmer

Detection pattern

high < sensitivity > low

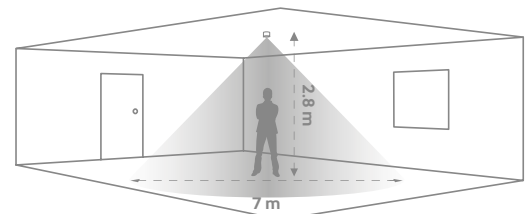

Dimensions (mm)

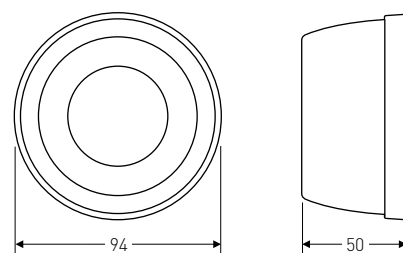

Guide for sensor selection - STAND ALONE

EBDMR | Compact PIR sensors, ceiling flush mounting, mid range.



Our series of compact flush mounted PIR presence/absence sensors with high performance faceted lens is suitable for use in open spaces or where a larger detection range is required.

- Mid range lens with concentric lens facets for improved detection
- Ideal for open plan offices
- Programmable : switching off time, brightness level (in lux) and other parameters using the configuration Gateway and the SmartBeam app
- IP40 rated
- 5-year warranty.

Detection pattern

high < sensitivity > low

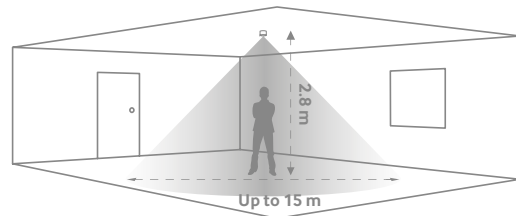

Dimensions (mm)

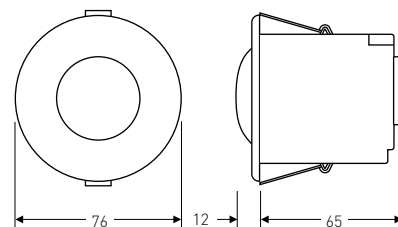

Orderable sensor variants

Item	FLUSH MOUNTING
	EBDMR
	PIR sensors for ceiling mounting
	Detection 360°. Range ø 15 m.
	Recommended fixing height: 2.8 m
Legrand Code	IP 40
CP110000	ON/OFF 10 A
CP110002	1-10 V 10 A analog dimmer
CP110001	DALI 10 A digital dimmer

EBMHS | Miniature PIR sensors, ceiling flush mounting.



This small, unobtrusive, but highly capable PIR presence/absence sensor is supplied pre-wired and with a connector that snap-fits into the power supply unit (PSU) for ease of installation.

- Small and unobtrusive design
- High sensitivity head for increased detection range
- Programmable : switching off time, brightness level (in lux) and other parameters using the configuration Gateway and the SmartBeam app.
- Supplied pre-wired with an RJ11 plug for connection into the power supply
- Supplied with power supply
- Available with standard or slim line PSU
- IP40 rated
- 5-year warranty.

Orderable sensor variants

Item	FLUSH MOUNTING
	EBMHS
	Miniature PIR presence detectors for ceiling mounting using a perforated control module
	Detection 360°, range ø 9-16 m
	Fixing height: from 2.8 to 7 m
Legrand Code	IP 40
CP140024	ON/OFF 3 A
CP140002	1-10 V 3 A analog dimmer
CP140010	DALI 3 A digital dimmer

Detection pattern

high < sensitivity > low

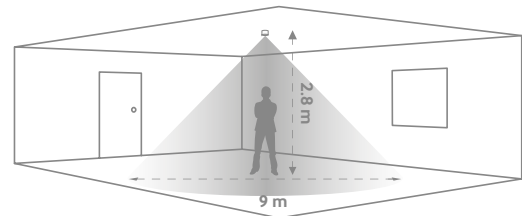

Dimensions (mm)

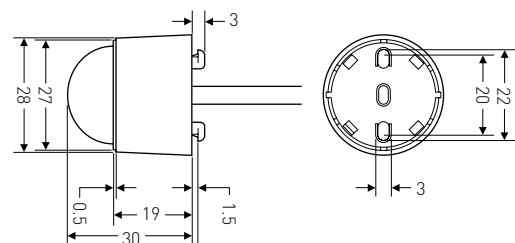

Guide for sensor selection - STAND ALONE

EBMPIR-MB | Miniature PIR sensors, luminaire mounting.

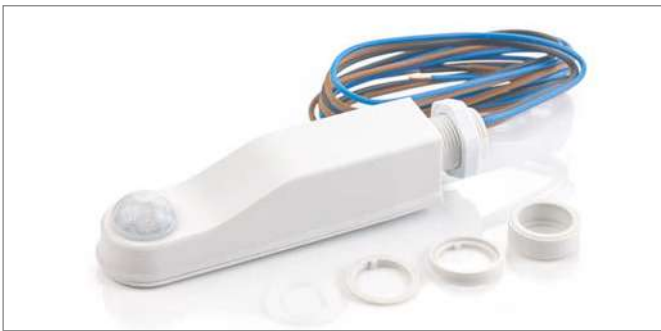

The EBMPIR-MB series of batten mount PIR presence sensors have been designed specifically for mounting on to a batten style luminaire.

- Luminaire or batten mounting solution
- Integrated power supply
- Suitable for a wide range of luminaires
- Pre wired with 1m cable
- Programmable : switching off time, brightness level (in lux) and other parameters using the configuration Gateway and the SmartBeam app
- IP65 rated for wet and damp environments which require an high IP65 protection
- For mounting at heights up to 7m
- Ideal for the lighting system retrofit
- 5-year warranty.

Orderable sensor variants

Item	FOR MOUNTING ON LUMINAIRES
	EBMPIR-MB Retrofit sensor on support Mounting on M20 Detection 360°, range ø 9-16 m Fixing height: from 2.8 to 7 m IP 65 Supplied with connection cables, about 1 m
CP160023	Retrofit sensor - ON/OFF 2 A IP 65
CP160016	Retrofit sensor - analog dimmer 1-10 V 2 A
CP160020	Retrofit sensor - digital dimmer DALI - 2 A

Detection pattern

high < sensitivity > low

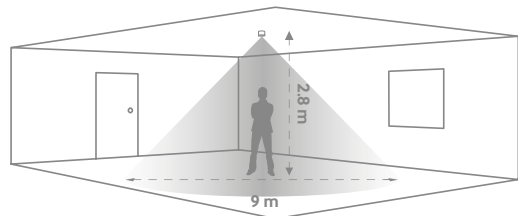

Dimensions (mm)

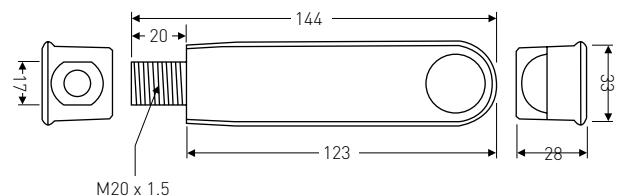

EBDRC | PIR sensors, ceiling flush mounting, long range for corridors, with swivel head.



Head can be adjusted to suit the detection pattern required.



Detection head position set to 15°



Detection head position set to 90°



The EBDRC series of PIR presence/absence sensors contains an adjustable head, and is fitted with a curtain lens for long range detection. Our directional PIR is suitable for mounting in aisleway and corridor applications where a long narrow detection pattern is required.

- Adjustable head
- Curtain lens for longer detection range
- Programmable : switching off time, brightness level (in lux) and other parameters using the configuration Gateway and the SmartBeam app
- IP40 rated
- Ideal for corridor applications
- 5-year warranty.

Detection pattern

high < sensitivity > low

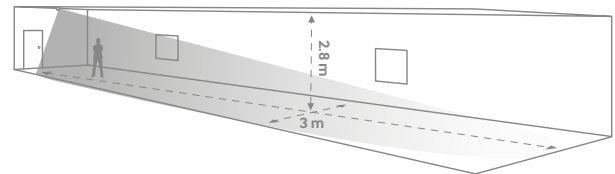

Sensitivity set to maximum
Detector head position set to 90°

Walk towards	10 m
Walk across	24 m

See page 15 for
Walk towards and
Walk across
explained.

Orderable sensor variants

Item FLUSH MOUNTING FOR CORRIDORS

EBDRC

PIR sensors with swivel head for corridors
Range up to 24 m
Recommended fixing height: 2.8 m
IP 40

CP111000	ON/OFF 10 A
CP111002	1-10 V 10 A analog dimmer
CP111001	DALI 10 A digital dimmer

Dimensions (mm)

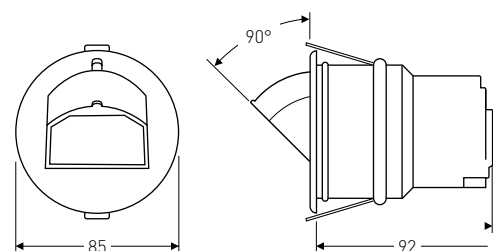

Guide for sensor selection - STAND ALONE

EBDHS | PIR sensors, flush mounting for very high rooms (high bay).



The EBDHS PIR presence/absence sensor is developed for lighting control in large areas with very high ceilings, such as industrial buildings or warehouses.

- For mounting at heights up to 15m depending on operating parameters
- Unique lens technology – high sensitivity
- Ideal for high level/high bay applications
- Programmable : switching off time, brightness level (in lux) and other parameters using the configuration Gateway and the SmartBeam app
- Supplied with adjustable masking shields to tailor detection zones
- IP40 rated
- 5-year warranty.

Detection pattern

high < sensitivity > low

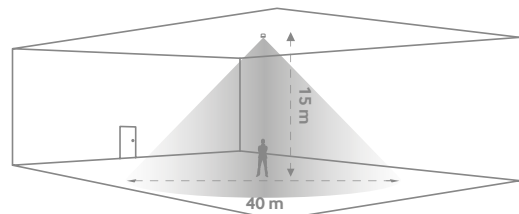

Dimensions (mm)

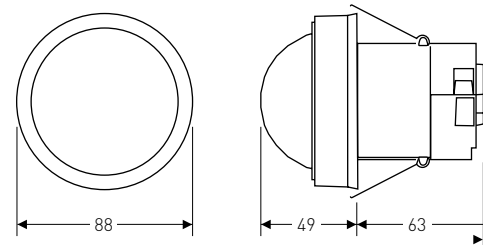

Orderable sensor variants

Item	FLUSH MOUNTING
	EBDHS PIR sensors for high ceilings Detection 360°, range ø 40 m with recommended fixing height: 15 m Adjustable detection zone (masking supplied) With 1 or 2 inputs for pushbutton control
CP100057	ON/OFF 10 A, IP 40
CP100059	analog dimmer 1-10 V 10 A, IP 40
CP100058	digital dimmer DALI 10 A, IP 40

EBDHS-MB | PIR sensors, luminaire mounting for very high rooms (high bay).



PATENTED DESIGN

The EBDHS-MB luminaire mounted PIR presence sensor series provides exceptionally wide range detection. They are ideal for controlling ceiling lighting in large rooms with high ceilings such as warehouses or industrial buildings.

- For mounting at heights up to 20m depending on operating parameters
- Unique lens technology – high sensitivity
- Ideal for high level/high bay applications
- Programmable : switching off time, brightness level (in lux) and other parameters using the configuration Gateway and the SmartBeam app
- Easy to install on luminaire and on electrical trunking even already existing
- Ideal for the lighting system retrofit
- IP40 rated
- 5-year warranty.

Detection pattern

high < sensitivity > low

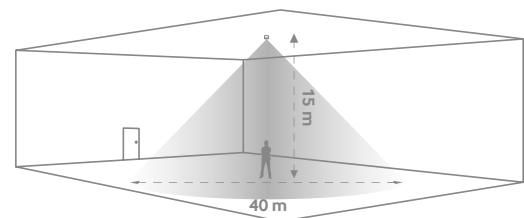

Dimensions (mm)

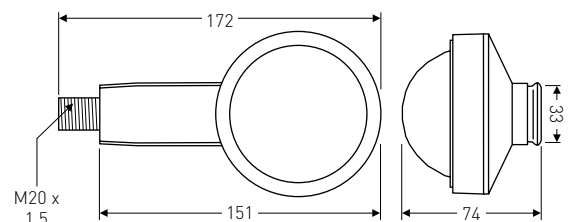

Orderable sensor variants

Item	FOR DIRECT MOUNTING ON LUMINAIRES
	EBDHS-MB Retrofit sensors for high ceilings M20 mounting on luminaires Detection 360°, range ø 40 m Adjustable detection zone, masking supplied Supplied with connection cables, about 1 m - IP 65 - 2A
CP100063	ON/OFF
CP100065	1-10 V analog dimmer
CP100064	DALI digital dimmer

Guide for sensor selection - STAND ALONE

MWS3A | MW sensors, ceiling flush mounting, long range for corridors, with swivel head.



Unlike fixed head microwave sensors, the MWS3A series of presence/absence sensors offers a unique adjustable head to suit the required detection pattern.

- Unique adjustable head design to achieve the required detection pattern
- Locking mechanism to prevent tampering
- Flush mounting
- Programmable : switching off time, brightness level (in lux) and other parameters using the configuration Gateway and the SmartBeam app
- IP40 rated
- 5-year warranty.

Orderable sensor variants

Item	FLUSH MOUNTING
	MWS3A MW sensors for ceiling mounting, with swivel head, for example, for corridors with range up to 23 m Recommended fixing height: 2.8 m IP 40
CP330037	ON/OFF 10 A
CP330045	ON/OFF 3 A 1 x NA/NC
CP330002	1-10 V 10 A analog dimmer
CP330022	DALI 10 A digital dimmer



Detection pattern

high < sensitivity > low

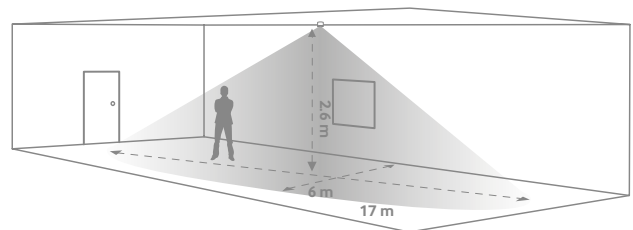

Sensitivity set to maximum
Detector head position set to 0°

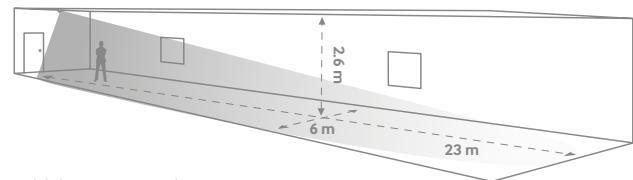

Sensitivity set to maximum
Detector head position set to 80°

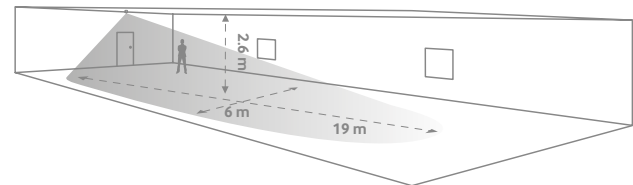

Sensitivity set to 80%
Detector head position set to 40°

Dimensions (mm)

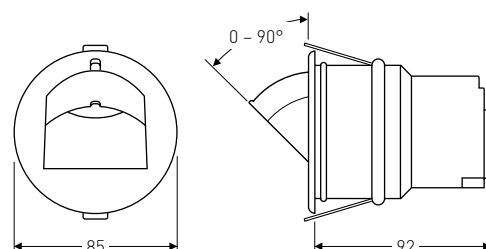

MWS5 | Compact MW sensors, ceiling surface/flush mounting or luminaire mounting.

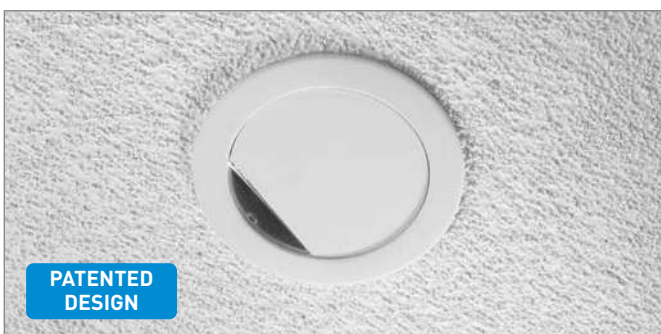

The MWS5 series of compact microwave presence/absence sensors has been specifically designed to be mounted within a luminaire. They are sensitive to movement and are ideal for large spaces that have an awkward shape.

- Can be flush or surface mounted
- Remote power supply allows head to be fitted in confined spaces
- Suitable for wall or ceiling mounted luminaires
- A selection of fixing clips to allow the unit to be mounted in or to the side of a luminaire is available
- Programmable : switching off time, brightness level (in lux) and other parameters using the configuration Gateway and the SmartBeam app
- Compact MW sensors, ceiling surface/flush mounting
- IP40 rated
- Supplied with power supply
- 5-year warranty

Detection pattern

high < sensitivity > low

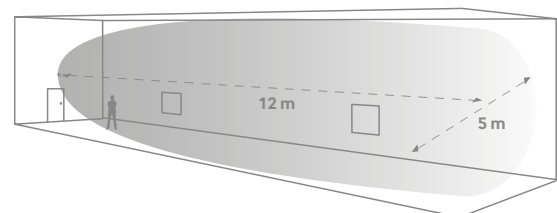
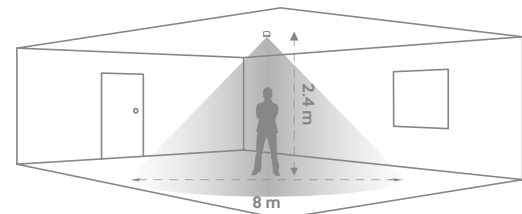

Orderable sensor variants

Item	FLUSH OR SURFACE MOUNTED
	MWS5 Mini MW sensors with management module for ceiling mounting Detection 360°, range ø 8 m Recommended fixing height: 2,4 m - IP 40
CP340013	ON/OFF 3 A
CP340002	1-10 V 3 A analog dimmer
CP340007	DALI 3 A digital dimmer

Dimensions (mm)

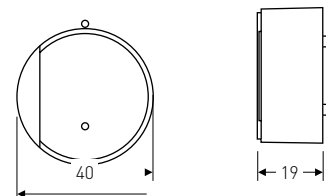

For power supply unit dimensions, please refer to the technical sheet that can be downloaded from the Legrand website.

Guide for sensor selection - STAND ALONE

MWS6 | Compact flat MW sensors, ceiling flush mounting.



The MWS6 is a low profile microwave presence/absence sensor for the automatic control of lighting, heating and ventilation.

- Low profile design
- IP40 rated
- Programmable : switching off time, brightness level (in lux) and other parameters using the configuration Gateway and the SmartBeam app
- 5-year warranty.

Detection pattern

high < sensitivity > low

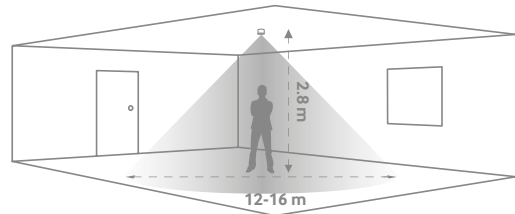

Orderable sensor variants

Item	FLUSH MOUNTING
	MWS6 Flat MW sensors Detection 360°, range ø 12-16 m Recommended fixing height: 2.8 m IP 40
CP360005	ON/OFF 10 A
CP360006	ON/OFF 6 A 2 outputs
CP360012	ON/OFF 3 A 1 x NA/NC
CP360008	ON/OFF 10 A 12-24 V AC/DC
CP360000	1-10 V 10 A analog dimmer
CP360001	DALI 10 A digital dimmer

Dimensions (mm)

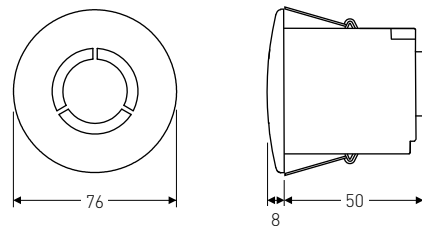

MWS6SM | Compact MW sensors, ceiling surface mounting.



The MWS6SM is a surface mounted mid-range microwave presence/absence sensor for the automatic control of lighting, heating and ventilation.

- Surface mounting
- Programmable : switching off time, brightness level (in lux) and other parameters using the configuration Gateway and the SmartBeam app
- Easy to install via a back plate
- IP40 rated
- 5-year warranty.

Detection pattern

high < sensitivity > low

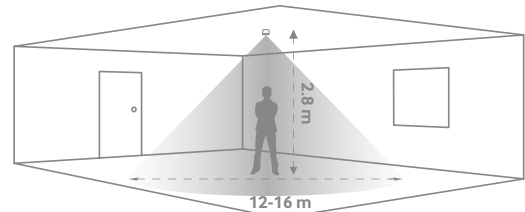

Orderable sensor variants

Item	WALL MOUNTING
	MWS6SM MW sensors for ceiling mounting Detection 360°, range ø 12 -16 m (oval detection zone) Recommended fixing height; 2,8 m IP40
CP360018	ON/OFF 3 A
CP360015	1-10 V 3 A analog dimmer
CP360016	DALI 3 A digital dimmer

Dimensions (mm)

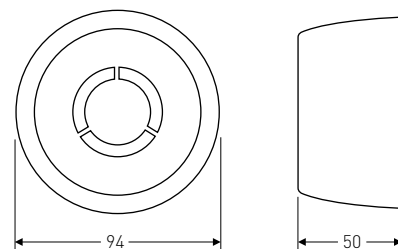

Guide for sensor selection - STAND ALONE

MWS1A | Square MW sensors, long range, wall semi-protruding mounting.



This range of wall mounted microwave presence sensors is designed to fit any flush-mounting box.

- Presence detection
- Programmable : switching off time, brightness level (in lux) and other parameters using the configuration Gateway and the SmartBeam app
- Suitable for heating and ventilation applications
- Compatible with flush-mounting boxes item 502E
- Fixing screw cap covers – smooth plate finish
- IP66 rated
- 5-year warranty.

Detection pattern

high < sensitivity > low

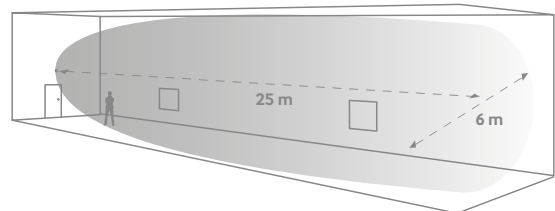

Orderable sensor variants

Item	WALL MOUNTING
	MWS1A MW Sensors Semi-protruding mounting Range 25 m, width 6 m Recommended fixing height: 2.8 m To be used with flush-mounting box (min. depth 25 mm) IP 40
CP320025	ON/OFF 6 A
CP320023	ON/OFF 6 A 12-24 V AC/DC 1 x NO/NC
CP320029	ON/OFF 3 A 1 x NA/NC

Dimensions (mm)

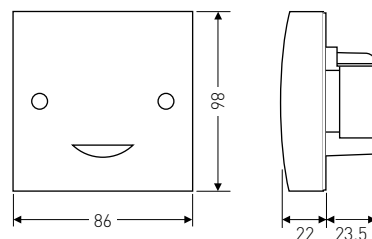

MWS1A-IP | Square MW sensors, long range, wall surface mounting, IP66.



This range of wall mounted microwave presence sensors are rated IP66 – suitable for use in damp environments.

- Unobtrusive design – vandal resistant
- Programmable : switching off time, brightness level (in lux) and other parameters using the configuration Gateway and the SmartBeam app
- Built in lux level sensing – enhanced energy saving
- Low voltage and volt free options – suitable for BMS and other control applications
- IP40 rated
- 5-year warranty.

Detection pattern

high < sensitivity > low

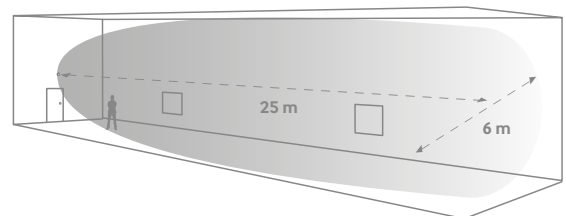

Orderable sensor variants

Item	WALL MOUNTING
	MWS1A-IP MW presence sensors Surface mounting Range 25 m, width 6 m Recommended fixing height: 2.8 m IP 66
CP320015	ON/OFF 6 A
CP320014	ON/OFF 6 A 12-24 V AC/DC 1 x NO/NC
CP320019	ON/OFF 3 A 1 x NA/NC

Dimensions (mm)

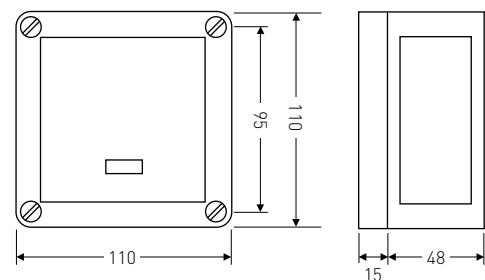

Guide for sensor selection - STAND ALONE

MWS1A-C | Square MW sensors, ceiling semi-protruding mounting (ceiling lights)



This range of ceiling mounted microwave presence sensors is designed to be installed in a flush-mounting box.

- Presence detection
- Programmable : switching off time, brightness level (in lux) and other parameters using the configuration Gateway and the SmartBeam app
- Suitable for heating and ventilation applications
- Compatible with flush-mounting boxes item 502E
- Fixing screw cap covers – smooth plate finish
- IP40 rated
- 5-year warranty.

Detection pattern

high < sensitivity > low

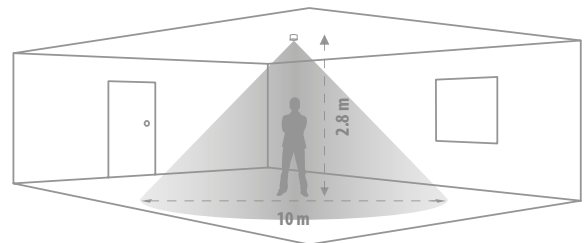

Orderable sensor variants

Item	CEILING MOUNTING
	MWS1A-C MW Sensors Semi-protruding mounting Detection 360°, range \varnothing 10 m Recommended fixing height: 2.8 m To be used with flush-mounting box (min. depth 25 mm) IP 40
CP320009	ON/OFF 6 A
CP320011	ON/OFF 3 A 1 x NA/NC

Dimensions (mm)

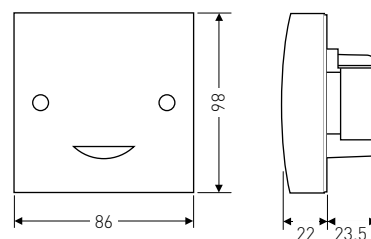

MWS1A-C-IP | Compact MW sensors, ceiling surface mounting (ceiling lights), IP66.



This range of ceiling mounted microwave presence sensors are rated IP66 – suitable for use in damp environments or where there is water.

- Presence detection
- Programmable : switching off time, brightness level (in lux) and other parameters using the configuration Gateway and the SmartBeam app
- Unobtrusive design – vandal resistant
- IP66 rated
- Built in lux level sensing – enhanced energy saving
- Low voltage and volt free options – suitable for BMS and other control applications
- Detection sensitivity more than 10 metres.
- Suitable for heating and ventilation management applications
- 5-year warranty.

Detection pattern

high < sensitivity > low

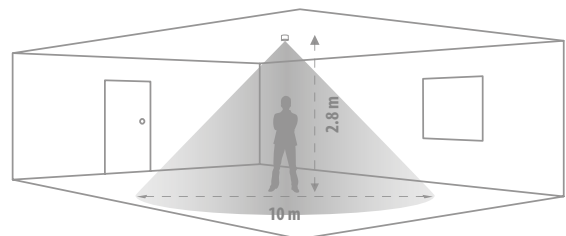

Orderable sensor variants

CEILING MOUNTING

MWS1A-C-IP

MW presence sensors

Surface mounting

Detection 360°, range ø 10 m

Recommended fixing height: 2.8 m

IP 66

CP320003 ON/OFF 6 A

CP320006 ON/OFF 3 A 1 x NA/NC

Dimensions (mm)

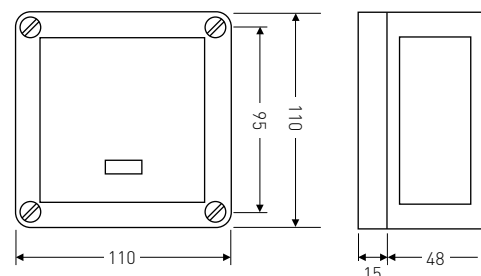

Stand Alone sensor programming

For the programming or the changing of the parameters of all stand alone sensors, it is possible to use the remote control (Configuration Gateway, item 0 882 40) in combination with the specific "Legrand Close UP" App.



The App is compatible with Android and Apple and can be downloaded from the related stores



Configuration gateway (Smartphone support base)

Thanks to the gateway design, it is possible to place the smartphone. The two devices communicate with each other via the "BLUETOOTH" protocol, while the gateway communicates the parameters to the sensors using IR (infrared) technology.



Features:

- The configuration gateway allows the adjustment of the presets and the detection sensitivity
- The configuration gateway can be used in conjunction with any IOS and Android device
- It is compatible with all stand alone lighting sensors.

Main functions:

- Change of product settings
- Store and recall of product configuration files
- Quick and easy configuration thanks to the copy/paste function
- Operational test functions
- Self-diagnosis function

Mobility at the service of installation and maintenance.

Stand Alone sensor programming

Legrand Close UP APP

The following pages introduce the **Close UP app**, used both for **product/system configuration and for changing the sensor parameters**. When modifying the sensors, the app must be used together with the **configuration Gateway**.

Easy lux learn

The common challenge faced when setting lux control for ceiling mounted detectors is determining the amount of light falling onto the area below.

This is due to the fact that detectors can only read the light vertically. Varying daylight flood from windows and multiple environment factors mean a calibration process is unavoidable.

Close UP simplifies this, providing a lux learn tool with which the user can adjust the sensor, following simple steps, to achieve the desired target set point.



Additional features



Laser-guided Programming

The product is equipped with a laser so it can guide the user to point at detectors up to 15 meters away. Essential for high bay and large area applications.



Customise and Organise

Once detector settings have been finalised for a specific room, they can be saved as a customised profile ready for re-call and re-use in similar rooms. Version updates and modification dates can be tracked using the filing system allowing for clearer authorisation and sign off processes.



Sensor calibration using the macros in the App

Refinements and updates can be easily made without the need to check each parameter thanks to macros that are available alongside the library of application profiles. For example, if the user wanted the detector to respond faster to changing daylight then the daylight macro can be uploaded to control that part of the system.

Simply modify and “beam” the changes directly to the detector.

Stand Alone sensor programming

Elements of Close UP

1 Close UP app

Download and install the **Close UP** app from Apple store for iOS devices or Google Play for Android devices. A database in the App allows the user to easily obtain updates and sample setups.

Graphical instructions will guide the user how to search for the configuration Gateway via the Bluetooth connection within the mobile device.

2 Close UP Profiles

Make the most of the ever growing number of SmartBeam profiles from CP Electronics. These are configuration profiles pre-made for various applications which are made available automatically once connected to the internet. Details of each of these profiles can be found on the CP Electronics website. Refine if necessary or "beam" directly as one batch to the detector.

3 Configuration gateway

Thanks to the gateway design, it is possible to place the smartphone. The two devices communicate with each other via the "BLUETOOTH" protocol, while the gateway communicates the parameters to the sensors using IR (infrared) technology.

The configuration Gateway uses USB charging, contains a built-in lux meter and has a firmware upgrade facility.



Order codes	Description
0 882 40	Configuration gateway

Use of the configuration gateway

The luminaire has a laser source with a collimated beam with diameter 7 mm or less at a distance of 100 mm from the output.

Do not make any changes to the laser source device.

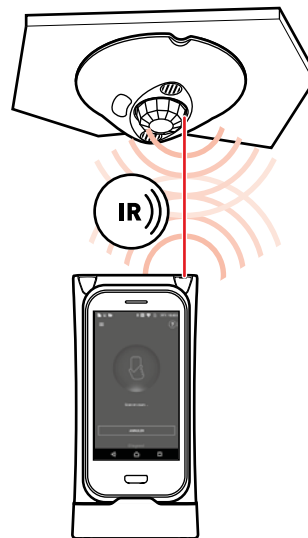

Close UP application profiles

When the library of application profiles is downloaded onto your mobile device, the **Close UP** app can access a folder of profiles covering different scenarios that may apply to lighting control situations. For example, the hotel lobby profile could be chosen for a hotel application, however, there is a deeper level of choices dependent on whether there's a more aggressive energy saving requirement or a more comfort conscious behaviour is needed.

Applications designed to allow for complete control

CP Electronics detectors are designed to tackle a wide variety of applications that often present the need for complex levels of control. More than 50 parameters of control are available to ensure the client's preferences can be met.

SmartBeam application profiles offer a perfect match using this wide range of parameters as part of pre-made profiles, making advanced features simple to implement. Through the step down warning function before 'switch off' or 'dim to minimum', safety-minded environments can be quickly developed by anyone.



Example: Meeting Room Projection Screen

Achieve multi-channel control with SmartBeam advanced application profiles. Easily control a meeting room equipped with a projection screen using occupancy control, daylight harvesting, master group and a separate whiteboard switching control.

The complexity of controlling four or more elements within a single system has been expertly addressed allowing smooth and efficient programming.



Example: Comfortable hotel corridor

An easy way to quickly implement a welcoming feel for those about to enter the corridor as lighting never switches off completely to darkness but dims to a low comfortable level.

It turns on quickly to normal brightness upon detection and dims to a step down level when someone leaves, saving energy seamlessly without disruption.

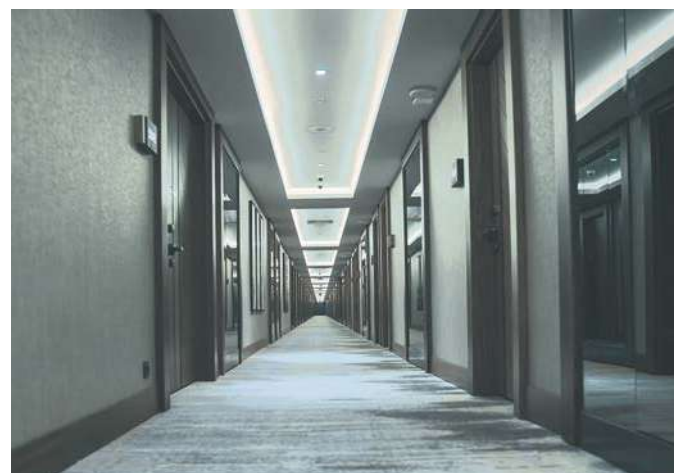

Guide for sensor selection

CASAMBI

CASAMBI Wireless technology sensors

Casambi is a professional lighting control system based on Bluetooth mesh technology.

With this low energy consumption technology, the devices create a network and the configuration is stored in the cloud and in the different devices. In this way, if any device fails at any time, the others reconfigure the network and continue to function perfectly.

This state-of-the-art wireless technology allows modern smartphones, tablets and even smart watches to control and manage the lighting system.

Their lighting control technology can be integrated into LED luminaires and drivers, to create a highly functional solution with minimal installation costs and effort.

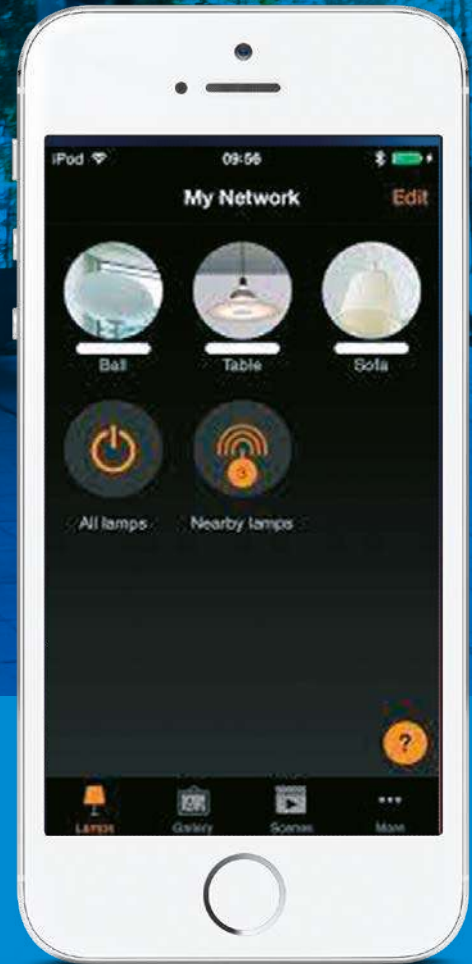

- **Mean of communication:**
Bluetooth LE 4.0
- **Product and system configuration:**
"CASAMBI" app
- **Modification of sensor parameters:**
"CASAMBI" app

Thanks to the compatibility of the application with Android and iOS operating systems, the **Casambi system** can be directly managed from a smartphone or tablet.

The CASAMBI app is compatible with Android and Apple and can be downloaded from the related stores.





Casambi is a wireless system with a range between devices of up to 30 metres indoors. With at least one device every 30 metres, virtually unlimited distances can be achieved.

The Casambi technology spans through a wide variety of manufacturers of equipment, controllers, drivers, sensors and controls that can be configured very easily using an intuitive App, and which can communicate with each other without the need for a mobile device.

Casambi wireless sensors

Many Casambi technology sensors only offer detection without control output, requiring the use of additional Casambi nodes or Casambi-enabled drivers inside the luminaires.

CP Electronics has designed the CASAMBI sensors with both relay output and DALI broadcast output, enabling the control of the luminaires without additional devices.

Without the use of additional nodes required for each luminaire, significant labour cost and time savings are possible.

Guide for sensor selection - CASAMBI

Main advantages of the CASAMBI wireless sensors

The Casambi system can adjust the intensity of the luminaires, creating different lighting scenarios and atmospheres. It allows total control of the luminaire from any mobile and remote control device. In addition, a device can be added to the installation to control the CASAMBI system through the Wi-Fi network.

Here are some of its advantages and benefits:

- Full lighting control using a mobile phone or tablet.
- Possibility of adding or removing CASAMBI devices as desired, without the need for installation changes or a technician.
- Possibility of fully independent creation or modification of scenarios, without the need for a technician.
- Monitoring of luminaire status at any time.
- Mobile phone notification in case of luminaire or driver fault.
- Possibility of remote control of the CASAMBI lighting system through the Wi-Fi network.
- Many CASAMBI devices allow management of the circadian cycle.



CASAMBI system management and potential



Update procedure of the CASAMBI system

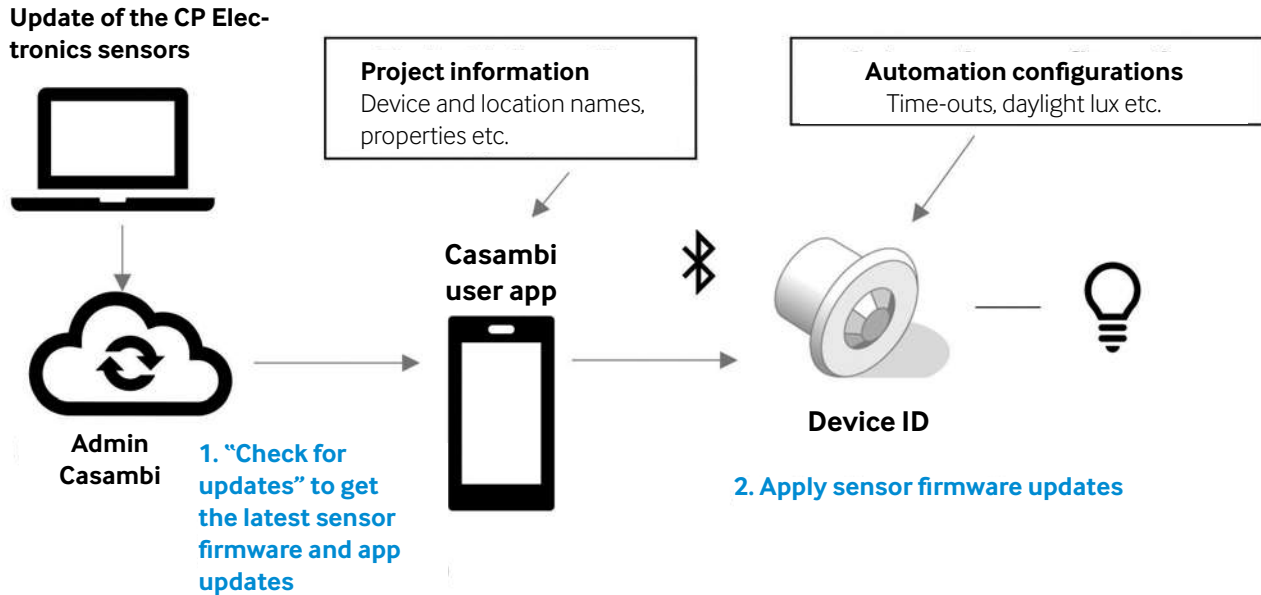

Typical wiring diagram of the CASAMBI sensor

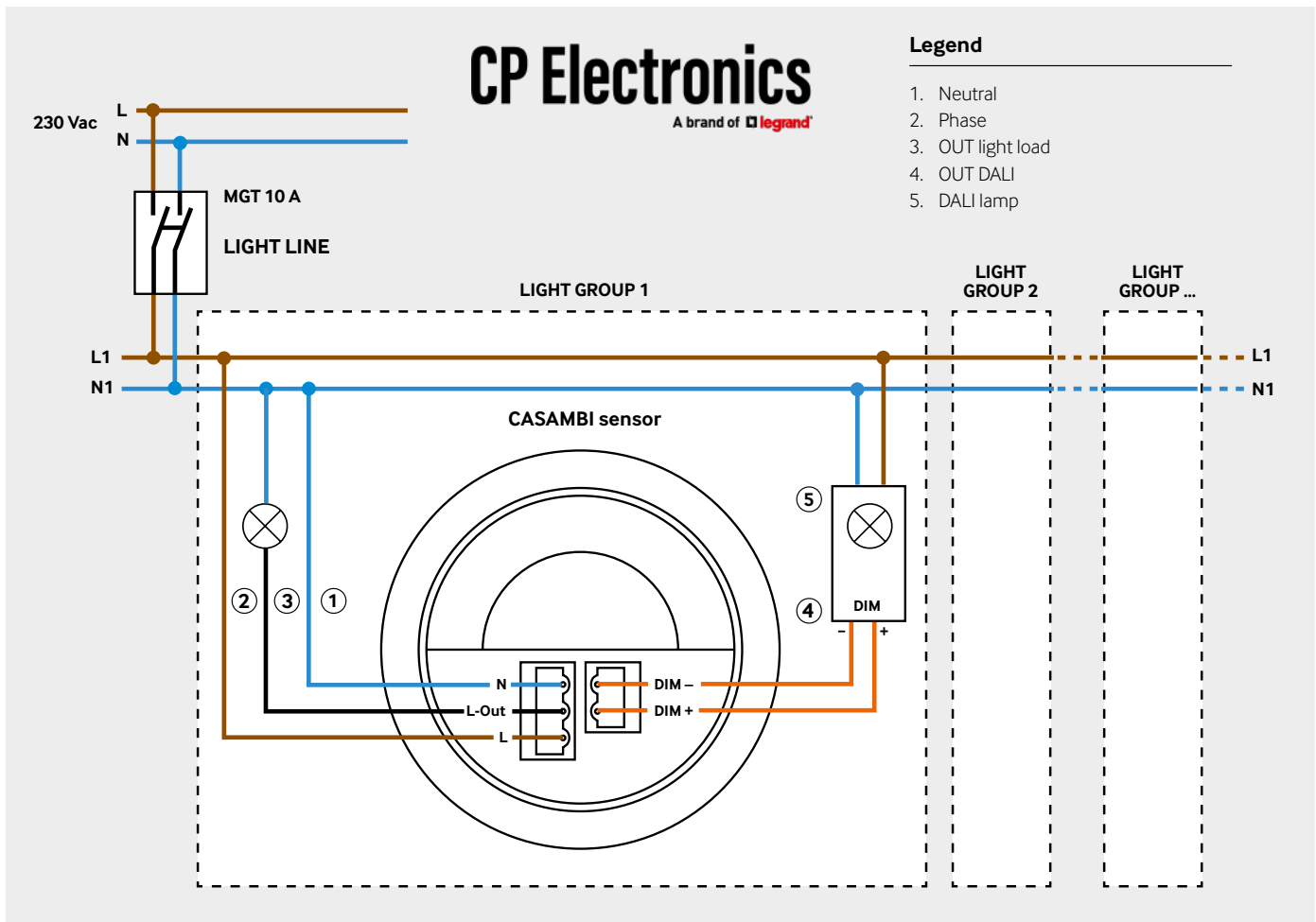

Guide for sensor selection - CASAMBI

Example Applications

Below are two examples of applications with CP Electronics wireless mesh presence detectors being used in conjunction with a Casambi wireless network. CP Electronics products are suitable for a wide variety of applications, please contact us for more information.

Office application

In an office application, triggering a detector sends a Bluetooth signal to all associated devices within the wireless mesh. The end user benefits from this decentralised set up with app based control via a smart device.

Accurate daylight harvesting balances luminaire output with the natural lighting available.

The compact EBDSPiR and the EBDMR mid-range detectors will then send a signal to adjust the light output of the luminaires

within a specified area (green dashed line), ensuring the efficient use of energy and maintaining a comfortable, safe working environment.

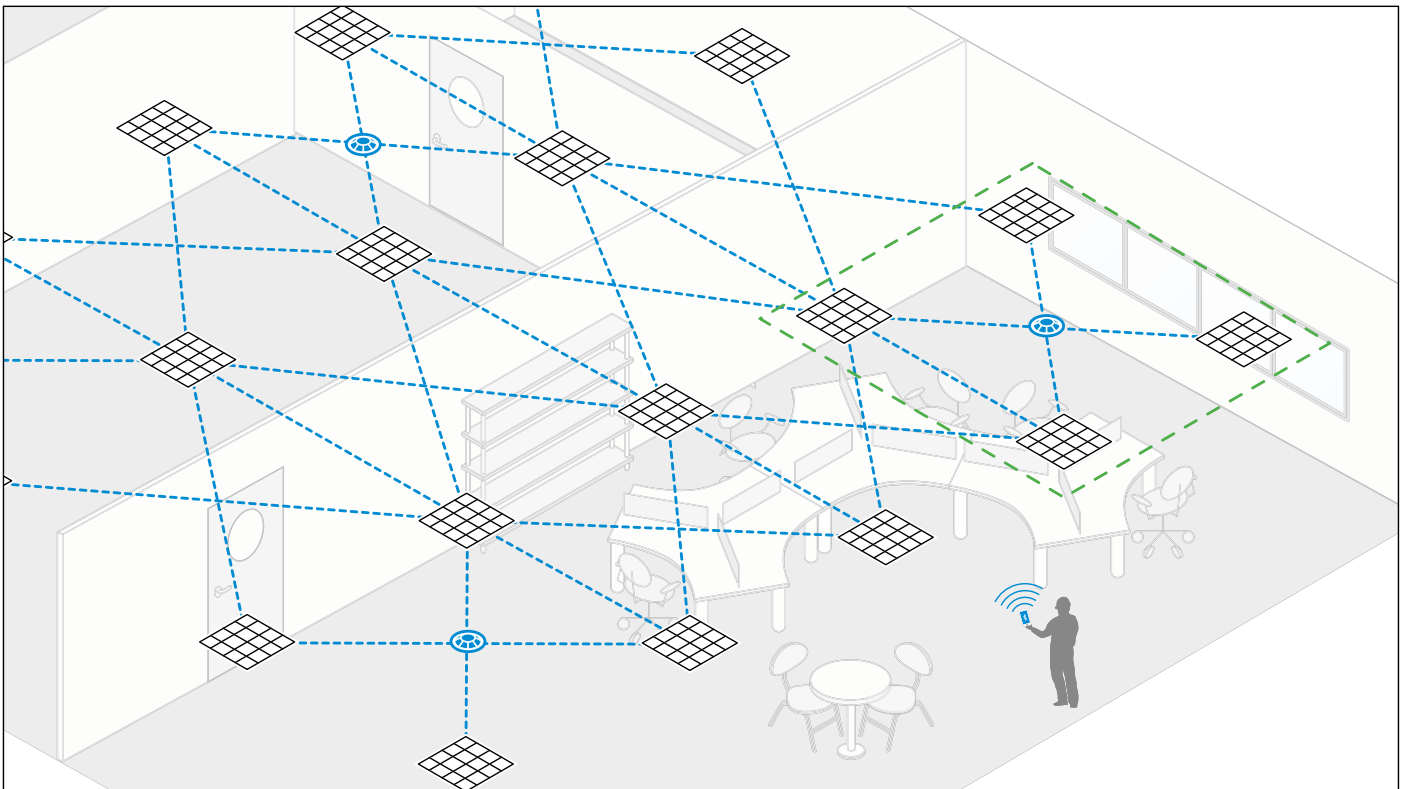

Legend

- Sensor
- Luminaire
- Bluetooth Mesh Network
- Zones
- Maintained Illuminance

CP Electronics

A brand of **legrand**

Warehouse application

The patented fresnel lens design along with a multi-pyro feature gives the EBDHS high bay detector its impressive detection performance.

By having a dedicated external light sensor, the detector is better able to offer precise readings of light level in a controlled space, an issue that is particularly demanding when mounted at high levels.

Its excellent wireless mesh range ability and wide detection capability makes it ideal for large space installations. The smart device programmability enables these detectors to offer the flexibility of adapting any group of lights to suit the needs of developing warehouse layouts including walk aisles and rackings.

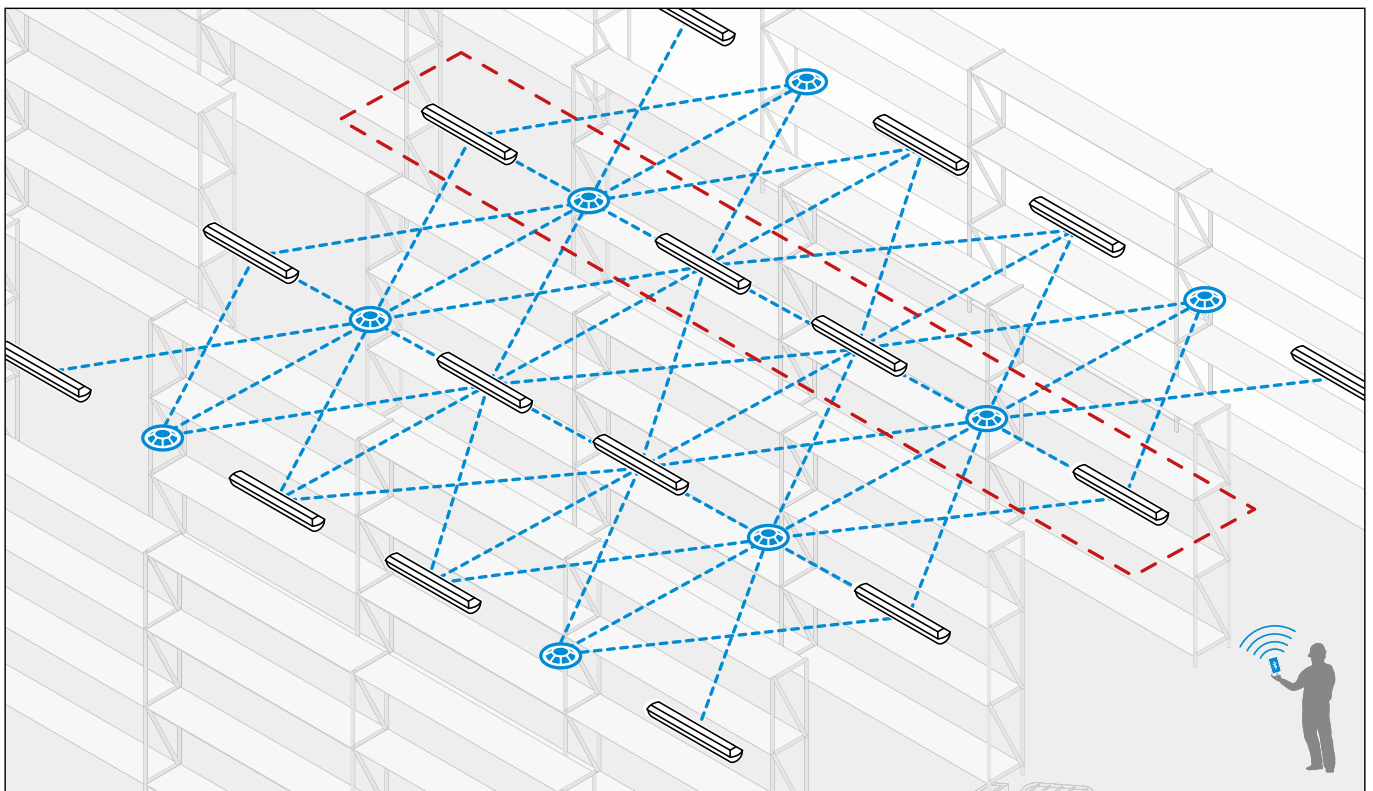

Legend

-  Sensor
-  Luminaire
-  Bluetooth Mesh Network
-  Zones
-  Maintained Illuminance

The range for the CASAMBI wireless technology sensors, includes the following products.



EBDSPIR

High sensitivity compact sensor

Key Features:

- Detection area diameter 7 m
- Low profile design
- Self contained unit
- Programmable time delay and lux settings with mobile app
- Provides automatic control for lighting and ventilation loads
- Relay and DALI output channels
- 5-year warranty



EBDMR

Mid Range compact sensor

Key Features:

- Detection area diameter 15 m
- New mid range lens with concentric lens facets for improved detection
- 360° presence and absence detection
- Ideal for open plan offices
- Relay and DALI output channels
- 5-year warranty



EBDHS-B

High sensitivity - High Bay compact sensor

Key Features:

- Detection area diameter 40 m
- Ground breaking detection range
- Unique lens technology – high sensitivity
- Ideal for high level/high bay applications
- Supplied with adjustable masking shields to tailor detection zones
- Relay and DALI output channels
- 5-year warranty

*** Check with us the latest Product LAUNCHES. New wireless sensors under development...**

Guide for sensor selection - CASAMBI

EBDSPIR-CB-DD | Compact PIR detectors in CASAMBI technology, Compact range, ceiling flush mounting.



Casambi Technology Explained:

The Casambi technology provides a Bluetooth Mesh network where all the intelligence of the system is replicated in every node and, in such a way, creates a system with no single point of failure. In this kind of fully distributed architecture, any device can go off-line and recover the information from other devices when they return back online.

Wireless Features:

- Control a large number of devices from any point
- Simple to use UI
- Wide range of functionality – Grouping Luminaires, different lighting situations for different occasions, colour temperature, daylight sensor, occupancy sensor and much more.

Sensor features:

- Provides movement and daylight readings to the Casambi network
- Provides also output connections to convert or retrofit any lighting devices to become part of the Casambi smart lighting system
- DALI dimming output (up to 10 lighting drivers)
- Built-in both switched relay and DALI dimming outputs
- 10A relay output
- Light level sensing
- Ideal for office and any general standard ceiling height applications
- 5-year warranty included.

Orderable sensors

Item	CEILING FLUSH MOUNTING
CP130068	flat PIR sensors for ceiling mounting Detection 360°, range ø 7 m Recommended fixing height: 2.8 m IP 40 DALI digital dimmer

Detection pattern

high < sensitivity > low

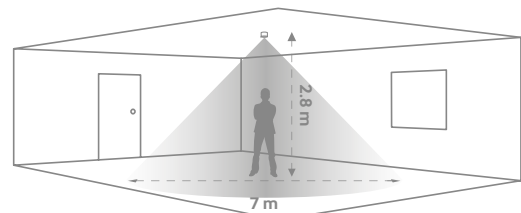

Dimensions (mm)

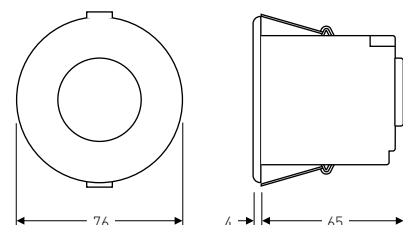

Guide for sensor selection - CASAMBI

EBDMR-CB-DD | Compact PIR detectors in CASAMBI technology, mid-range, ceiling flush mounting.



Casambi Technology Explained:

The Casambi technology provides a Bluetooth Mesh network where all the intelligence of the system is replicated in every node and, in such a way, creates a system with no single point of failure. In this kind of fully distributed architecture, any device can go off-line and recover the information from other devices when they return back online.

Wireless Features:

- Control a large number of devices from any point
- Simple to use UI
- Wide range of functionality – Grouping Luminaires, different lighting situations for different occasions, colour temperature, daylight sensor, occupancy sensor and much more.

Sensor features:

- Provides movement and daylight readings to the Casambi network
- Provides also output connections to convert or retrofit any lighting devices to become part of the Casambi smart lighting system
- Mid-range sensor lens with concentric lens facets for improved detection
- DALI dimming output (up to 10 lighting drivers)
- Built-in both switched relay and DALI dimming outputs
- 10A relay output
- Light level sensing
- Ideal for office and any general standard ceiling height applications
- 5-year warranty included

Orderable sensors

Item	CEILING FLUSH MOUNTING
CP100055	flat PIR sensors for ceiling mounting Detection 360°, Range ø 15 m. Recommended fixing height: 2.8 m IP 40 DALI digital dimmer

Detection pattern

high < sensitivity > low

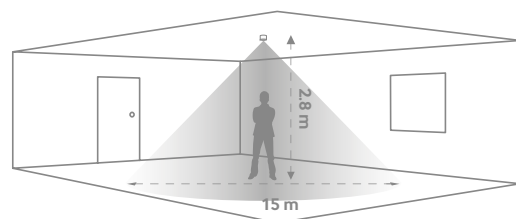

Dimensions (mm)

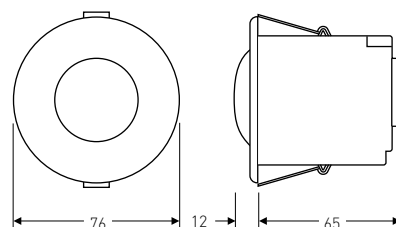

Guide for sensor selection - CASAMBI

EBDHS-B-CB-DD | Compact PIR detectors in CASAMBI technology, **LONG**-range, ceiling flush mounting. For high high bay installations



Casambi Technology Explained:

The Casambi technology provides a Bluetooth Mesh network where all the intelligence of the system is replicated in every node and, in such a way, creates a system with no single point of failure. In this kind of fully distributed architecture, any device can go off-line and recover the information from other devices when they return back online.

Wireless Features:

- Control a large number of devices from any point
- Simple to use UI
- Wide range of functionality – Grouping Luminaires, different lighting situations for different occasions, colour temperature, daylight sensor, occupancy sensor and much more.

Sensor Features:

- Ground breaking detection range up to 40 m at a 15 m mounting height
- Maximum mounting height up to 20m dependent on operating parameters
- Multi-pyro design offers greater sensitivity without false triggering
- Unique lens technology – high sensitivity within the detection range
- Built-in both switched relay and DALI dimming outputs
- Ideal for high bay applications, including warehouse lighting control
- IP40 rated
- Supplied with adjustable masking shields to tailor detection zones
- 5-year warranty included

Orderable sensors

Item	FOR HIGH CEILINGS
CP100053	flat PIR sensors for high ceilings Detection 360°, range \varnothing 40 m with recommended fixing height: 15 m Adjustable detection zone (masking supplied) DALI digital dimmer

Detection pattern

high < sensitivity > low

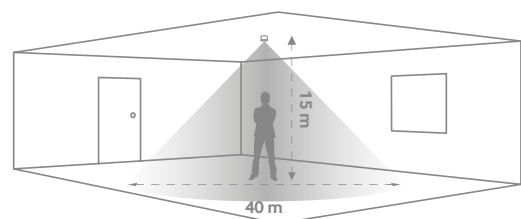

Dimensions (mm)

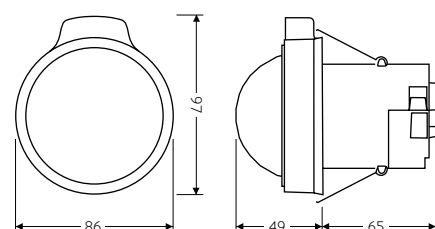

Guide for sensor selection



KNX wired BUS technology sensors

The range for the CP Electronics KNX sensors includes the following products:



EBDSPIR-KNX
(Item CP130032)

Compact PIR presence sensor, ceiling flush mounting, in KNX technology.



EBDSPIR-KNX-MR
(Item CP130071)

Compact PIR presence sensor, ceiling flush mounting, in KNX technology.
Mid range



MWS3A-KNX
(Item CP330027)

Compact MW microwave presence sensor, with adjustable head, ceiling flush mounting, in KNX technology.

Special features: 2 ELV inputs, scene selection....

In addition to STAND ALONE and CASAMBI sensors, the **CP Electronics'** range also includes **KNX technology** sensors.

These sensors complement Legrand's KNX offer already available on the market.



EBDHS-KNX
(Item CP100018)

Compact PIR presence sensor, flush mounting, for very High Bay, in KNX technology.



MWS6-KNX
(Item CP36003)

Compact MW microwave presence sensor, ceiling flush mounting, in KNX technology.

Special features: 2 ELV inputs, scene selection....

Guide for sensor selection - KNX®

EBDSPIR-KNX | Compact PIR sensor in KNX technology, ceiling flush mounting



EBDSPIR-KNX is a compact PIR detector suitable to be mounted either flush or in a surface mount box. Designed with KNX **standard input connectors**. EBDSPIR-KNX is simple to install and suitable for narrow ceiling voids and still offers sensitive detection.

Features:

- Two low voltage switch inputs to manually override the dimming levels and / or override the lights on or off
- KNX programming mode accessible with IR handset and also by using the push switch on the back of the unit
- Programmable logic block. It is possible to adjust or manage some conditions or logics.
For example: send the occupancy telegram only if the switch is pressed and the brightness level (in lux) is below the configured threshold.
- All functionality is fully programmable using the KNX ETS commissioning software
- 5-year warranty included

Detection pattern

high < sensitivity > low

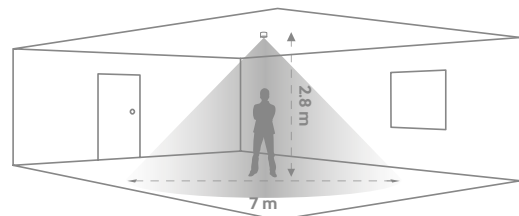

Dimensions (mm)

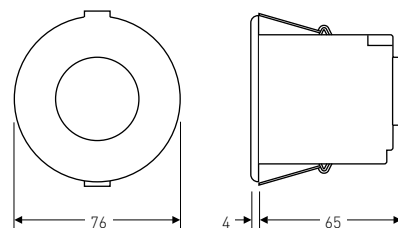

Orderable sensors

Item	CEILING FLUSH MOUNTING
CP130032	presence/absence detector, PIR, KNX, compact dimensions, IP40 rated, for ceiling applications, flush mounting

EBDHS-KNX | Compact PIR sensor in knx technology, ceiling flush mounting, for high ceilings, IP65.



EBDSPIR-KNX is a compact PIR detector suitable to be mounted either flush or in a surface mount box. Designed with KNX standard input connectors. EBDSPIR-KNX is simple to install and suitable for narrow ceiling voids and still offers sensitive detection.

Features:

- Ground breaking detection range up to 40 m at a 15 m mounting height
- Two low voltage switch inputs to manually override the dimming levels and / or override the lights on or off
- KNX programming mode accessible with IR handset and also by using the push switch on the back of the unit
- Programmable logic block. It is possible to adjust or manage some conditions or logics.
For example: send the occupancy telegram only if the switch is pressed and the brightness level (in lux) is below the configured threshold.
- All functionality is fully programmable using the KNX ETS commissioning software
- 5-year warranty included.

Detection pattern

high < sensitivity > low

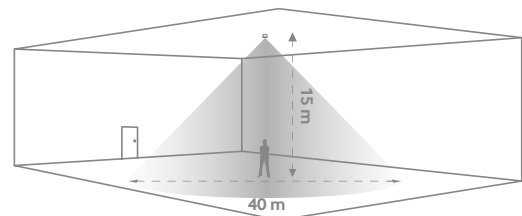

Dimensions (mm)

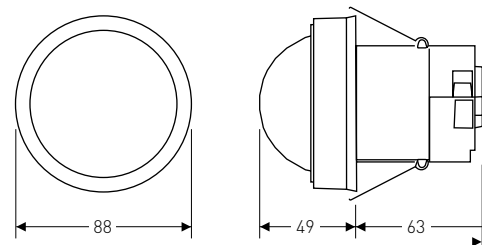

Orderable sensors

Item	FOR HIGH CEILINGS
CP100018	PIR presence detector, KNX, very sensitive, IP65 rated, for high ceiling applications, flush mounting

Guide for sensor selection - KNX®

MWS6-KNX | Compact MW sensor in KNX technology, ceiling flush mounting.



MWS6-KNX is a low profile microwave detector suitable to be flushed mounted or in a surface mount box. Designed with KNX standard input connectors. The MWS6-KNX sensor is simple to install and suitable for a variety of applications where aesthetic and unobtrusive luminaires are required.

Features:

- Range up to 16m at 2.8m mounting height
- Two low voltage switch inputs to manually override the dimming levels and / or override the lights on or off
- KNX programming mode accessible with IR handset and also by using the push switch on the back of the unit
- Programmable logic block. It is possible to adjust or manage some conditions or logics.
For example: send the occupancy telegram only if the switch is pressed and the brightness level (in lux) is below the configured threshold.
- All functionality is fully programmable using the KNX ETS commissioning software
- 5-year warranty included.

Detection pattern

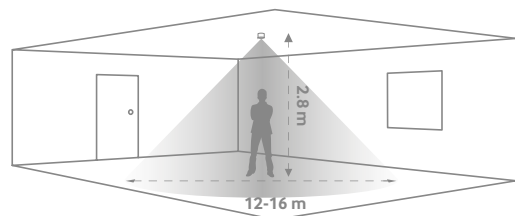

Dimensions (mm)

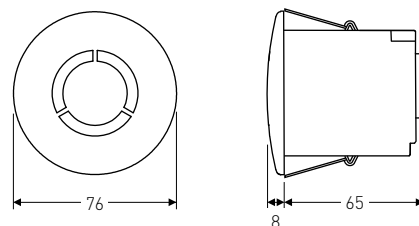

Orderable sensors

Item	CEILING FLUSH MOUNTING
CP360003	presence/absence detector, microwave (MW) technology, KNX, compact dimensions, IP40 rated, for ceiling applications, flush mounting

MWS3A-KNX | Compact MW sensor in KNX technology, ceiling flush mounting, with adjustable head.



Unlike fixed head microwave presence detectors the MW3SA-KNX offers a unique presence/absence detection capability by using an adjustable head. This incorporates an innovative locking mechanism to prevent tampering.

Features:

- Range up to 23m at 2.6m mounting height
- Two low voltage switch inputs to manually override the dimming levels and / or override the lights on or off
- KNX programming mode accessible with IR handset and also by using the push switch on the back of the unit
- Programmable logic block. It is possible to adjust or manage some conditions or logics.
For example: send the occupancy telegram only if the switch is pressed and the brightness level (in lux) is below the configured threshold.
- All functionality is fully programmable using the KNX ETS commissioning software
- 5-year warranty included.

Detection pattern

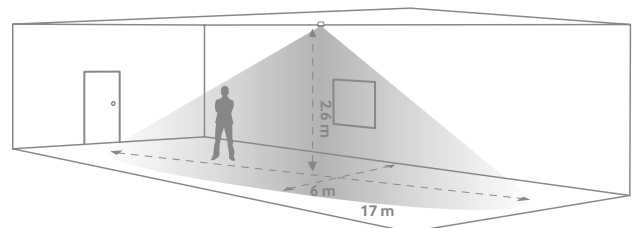

Sensitivity set to maximum
Detector head position set to 0°

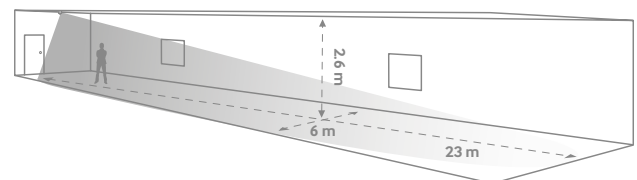

Sensitivity set to maximum
Detector head position set to 80°

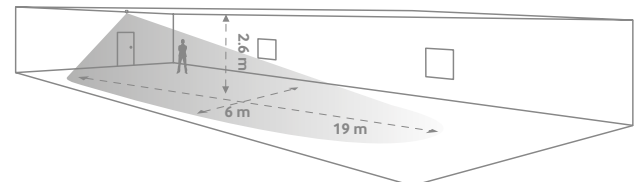

Sensitivity set to 80%
Detector head position set to 40°

Dimensions (mm)

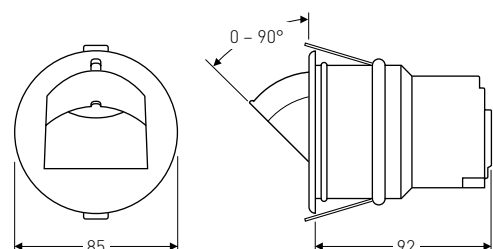

Orderable sensors

Item	CEILING FLUSH MOUNTING
CP330027	presence/absence detector, microwave (MW technology, KNX, adjustable head, IP40 rated, for ceiling applications, flush mounting

Applications

This section shows real examples of projects, with sensors applied and installed in various environments.

Each project example includes:

- **Application description**
- **Floor plan of the room with sensor positioning**
- **Photo of suggested sensor**
- **Electric diagram**



CP Electronics

A brand of  Legrand

Application Index

1.	Single office (DALI stand alone)	60
2.	Open plan office (DALI stand alone)	62
3.	Meeting room (DALI stand alone)	64
4.	Corridor (DALI stand alone)	66
5.	Windowless bathroom (stand alone on-off)	68
6.	Airport - service station toilets (stand alone on-off)	70
7.	Classroom with blackboard (DALI stand alone)	72
8.	Warehouse (DALI stand alone)	74
9.	Covered car park (stand alone on-off)	76
10.	Office hall/reception (CASAMBI)	78
11.	Solution to manage the whole building (KNX)	80

The proposed applications are only examples:
for each application, there are multiple solutions depending on the décor,
type of ceiling and installation height, type of luminaires and so on.

APPLICATION No. 1

Single office (DALI stand alone)



MANAGEMENT: ON/OFF - daylight - manual forcing with pushbutton (also dimming)

DETECTION: absence

SENSOR USED: DALI STAND ALONE

FAMILY: EBDSPIR

CODE: CP130018

APPLICATION DESCRIPTION

The flush-mounting PIR sensor is installed as close to the desk as possible to ensure optimum detection.

The luxmeter function of the sensor allows the management of the appropriate lighting level, in line with the lux values set during the configuration. A dedicated button can be used to switch the light on/off and adjust its intensity.



NOTES:

1. Install the sensor away from heat sources.
2. For ceilings up to 2.8 m high, allow for an EBDSPIR family sensor; for higher ceilings, use a microwave sensor.
3. When using an on-board relay, connect up to 10 DALI ballasts (maximum energy saving), otherwise connect up to a maximum of 20 DALI ballasts.
4. Configuration with daylight function not possible in case of dual-emission lights, i.e. emitting in the direction of the sensor.
5. Absence function configuration is recommended, to maximise energy savings and avoid unnecessary switching on.
6. Use a double control 1P NO / 1P NO.
7. To avoid possible obstacles, evaluate the space requirements for furniture (e.g. PC monitor).

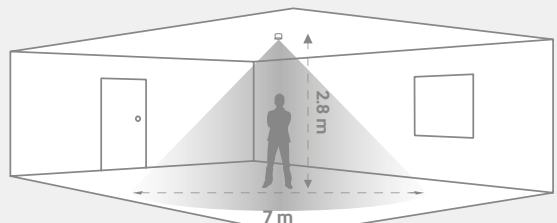

FLOOR PLAN

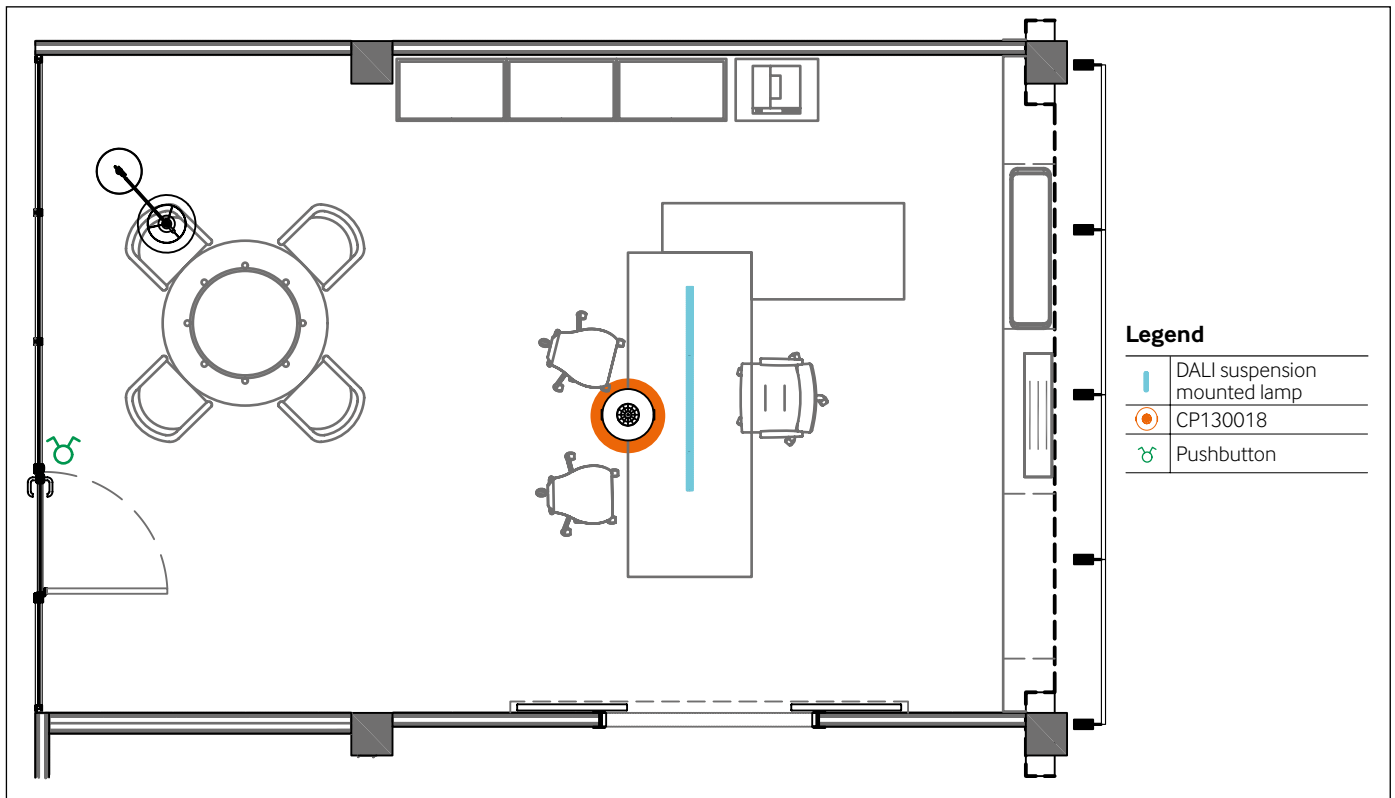

ELECTRIC DIAGRAM

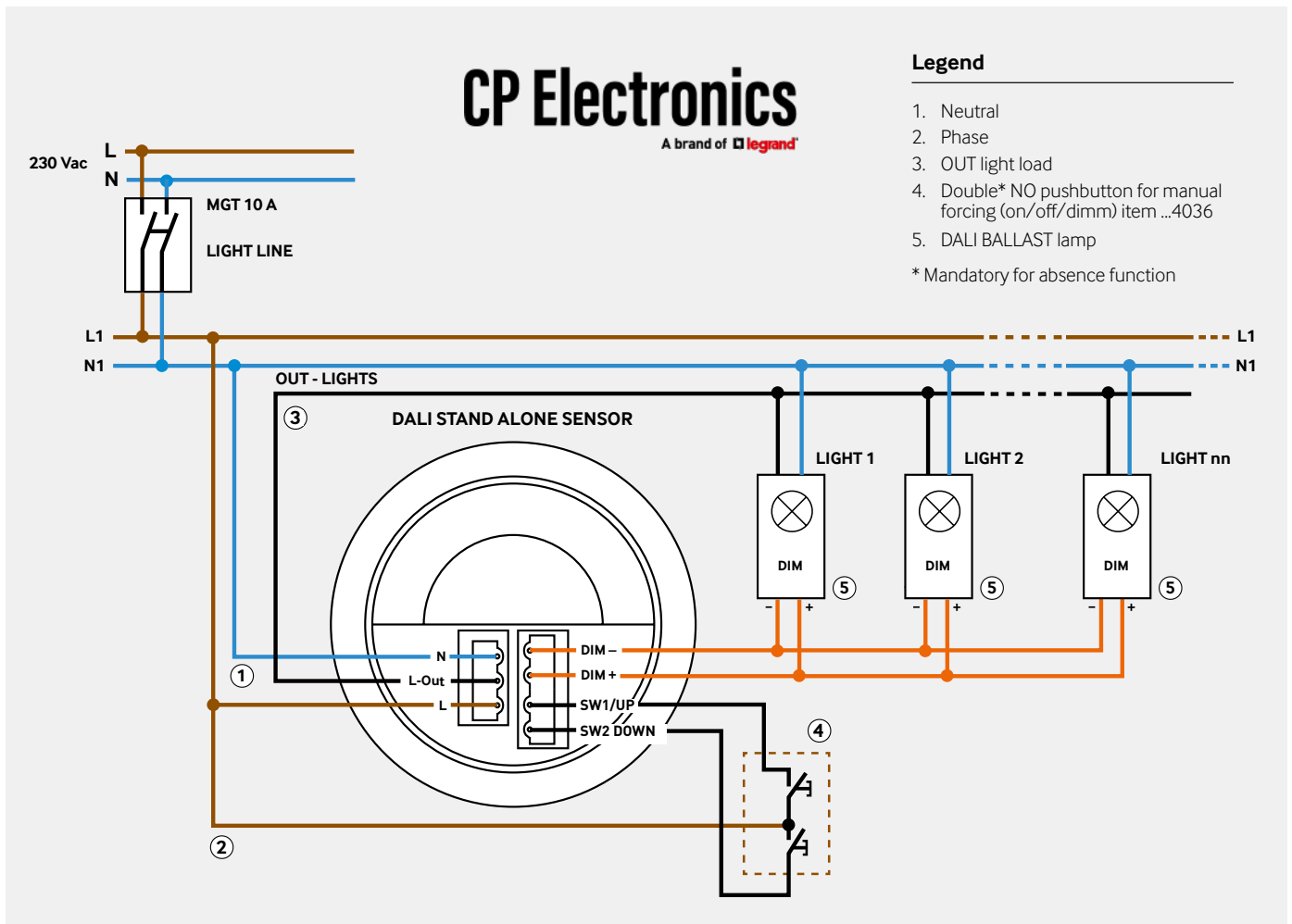

APPLICATION No. 2

Open plan office (DALI stand alone)



MANAGEMENT: ON/OFF - daylight - manual forcing with pushbutton (also dimming)

DETECTION: presence

APPLICATION DESCRIPTION

In open-plan offices, the number of detectors is quantified in relation to the control groups and the device coverage. Each group of desks will be associated with a lighting group and their corresponding sensor, creating "islands" within the room.

The daylight function - i.e. adjustment of the lighting level depending on the level of natural light inside the environment - is managed by the sensor for its group of lights. Using a dedicated button, it is also possible to manually force the behaviour (on, off, dimmer).

In case of open space application, the installation of the pushbuttons should often be avoided, leaving the system to always operate in automatic mode.

SENSOR USED: DALI STAND ALONE

FAMILY: EBDMR

CODE: CP110001



NOTES:

1. Install the sensor away from heat sources.
2. For ceilings up to 2.8 m high, allow for an EBDMR family sensor; for higher ceilings, use a microwave sensor.
3. When using an on-board relay, connect up to 10 DALI ballasts (maximum energy saving), otherwise connect up to a maximum of 20 DALI ballasts.
4. Configuration with daylight function not possible in case of dual-emission lights, i.e. emitting in the direction of the sensor.
5. Presence function configuration is recommended, to ensure service lighting levels every time a presence is detected in the environment.
6. It is recommended to use a 1P NO / 1P NO dual control; to use a conventional pushbutton, configuration through the APP is required.

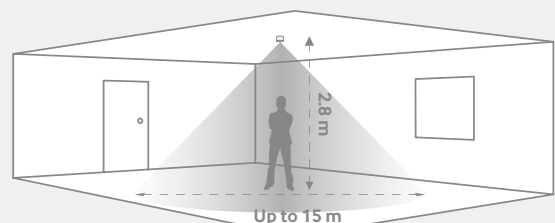

FLOOR PLAN

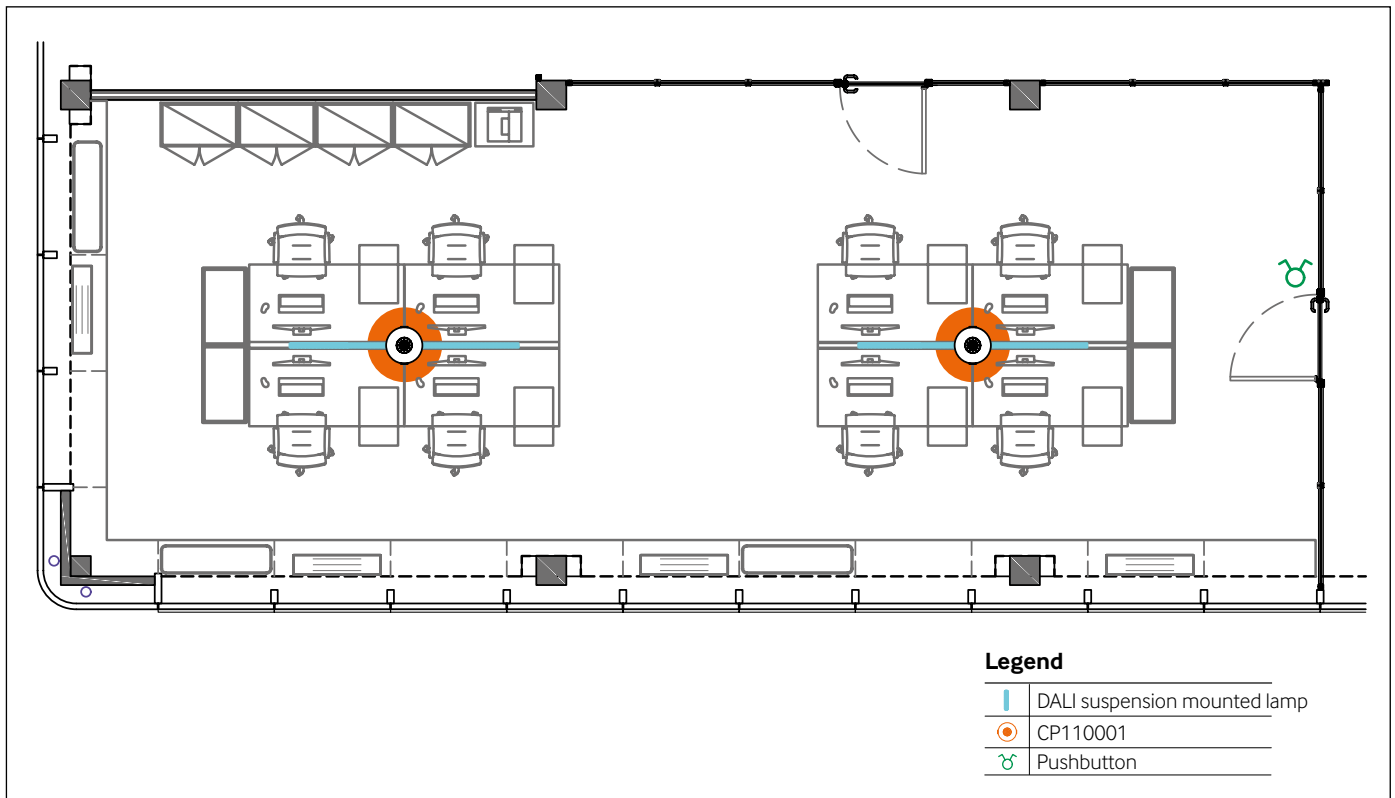

ELECTRIC DIAGRAM

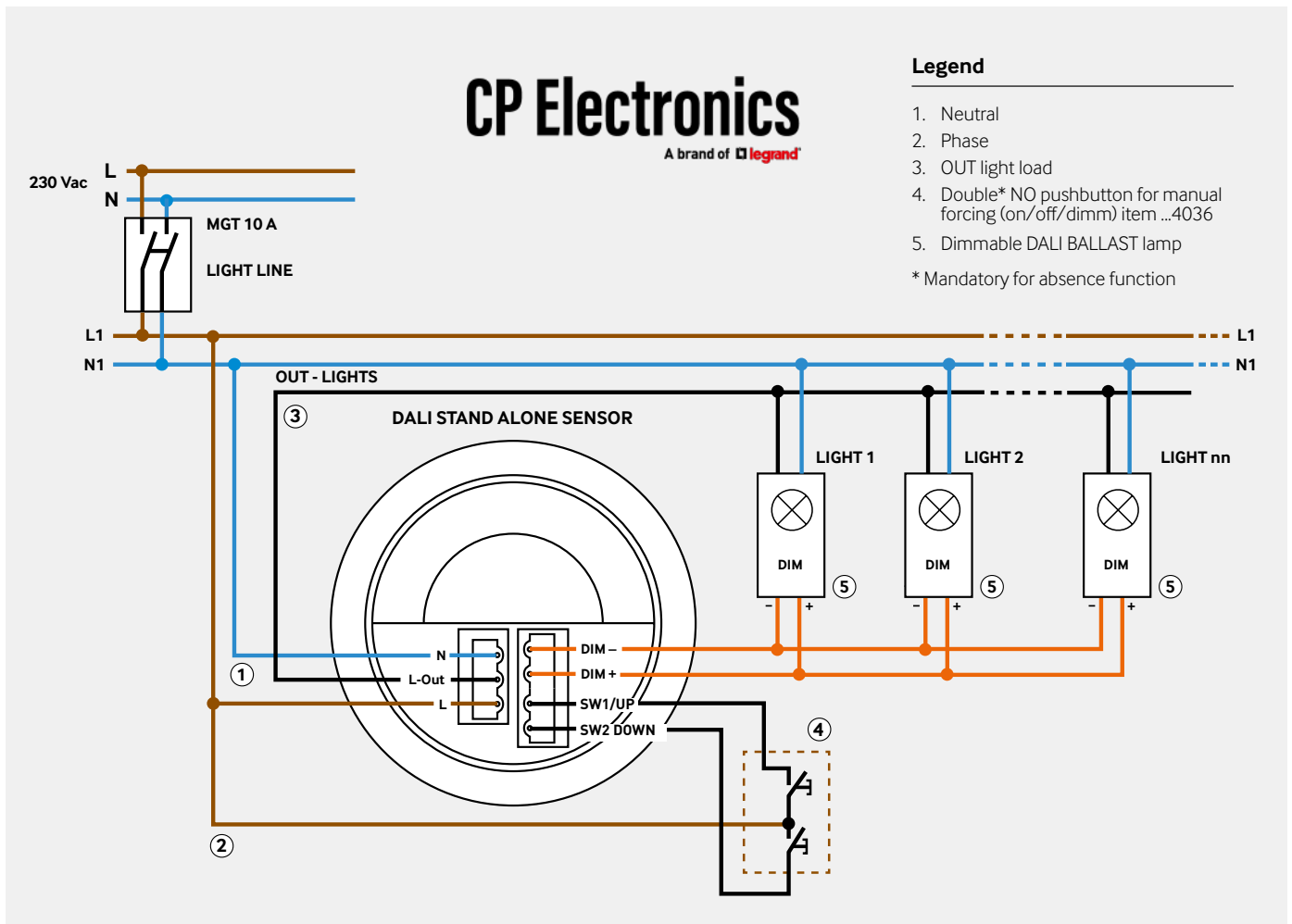

APPLICATION No. 3

Meeting room (DALI stand alone)



MANAGEMENT: ON/OFF - daylight - manual forcing with pushbutton (also dimming)

DETECTION: absence

APPLICATION DESCRIPTION

To ensure adequate presence detection in a larger environment, for example meeting rooms, a microwave sensor should be installed, with a coverage of up to 12 m and capable of detecting even the smallest movement.

The daylight function, meaning the adjustment of the lighting level according to the own brightness of the environment, is only handled by the sensor (up to 10 ballasts).

A dedicated pushbutton can be used to switch the light on/off and adjust its intensity.

It is also possible to adjust the "sensitivity when off" to lower values to avoid unwanted switching on, and to set the "sensitivity when on" to maximum, to also detect even the smallest movements.

SENSOR USED: DALI STAND ALONE

FAMILY: MWS6

CODE: CP360001



NOTES:

1. Install the sensor away from heat sources.
2. When using an on-board relay, connect up to 10 DALI ballasts (maximum energy saving), otherwise connect up to a maximum of 20 DALI ballasts.
3. Configuration with daylight function not possible in case of dual-emission lights, i.e. emitting in the direction of the sensor.
4. Absence function configuration is recommended, to maximise energy savings and avoid unnecessary switching on.
5. It is recommended to use a 1P NO / 1P NO dual control; to use a conventional pushbutton, configuration through the APP is required.

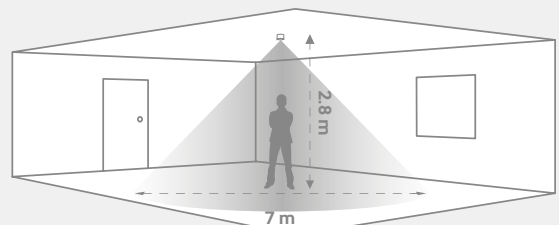

FLOOR PLAN



ELECTRIC DIAGRAM

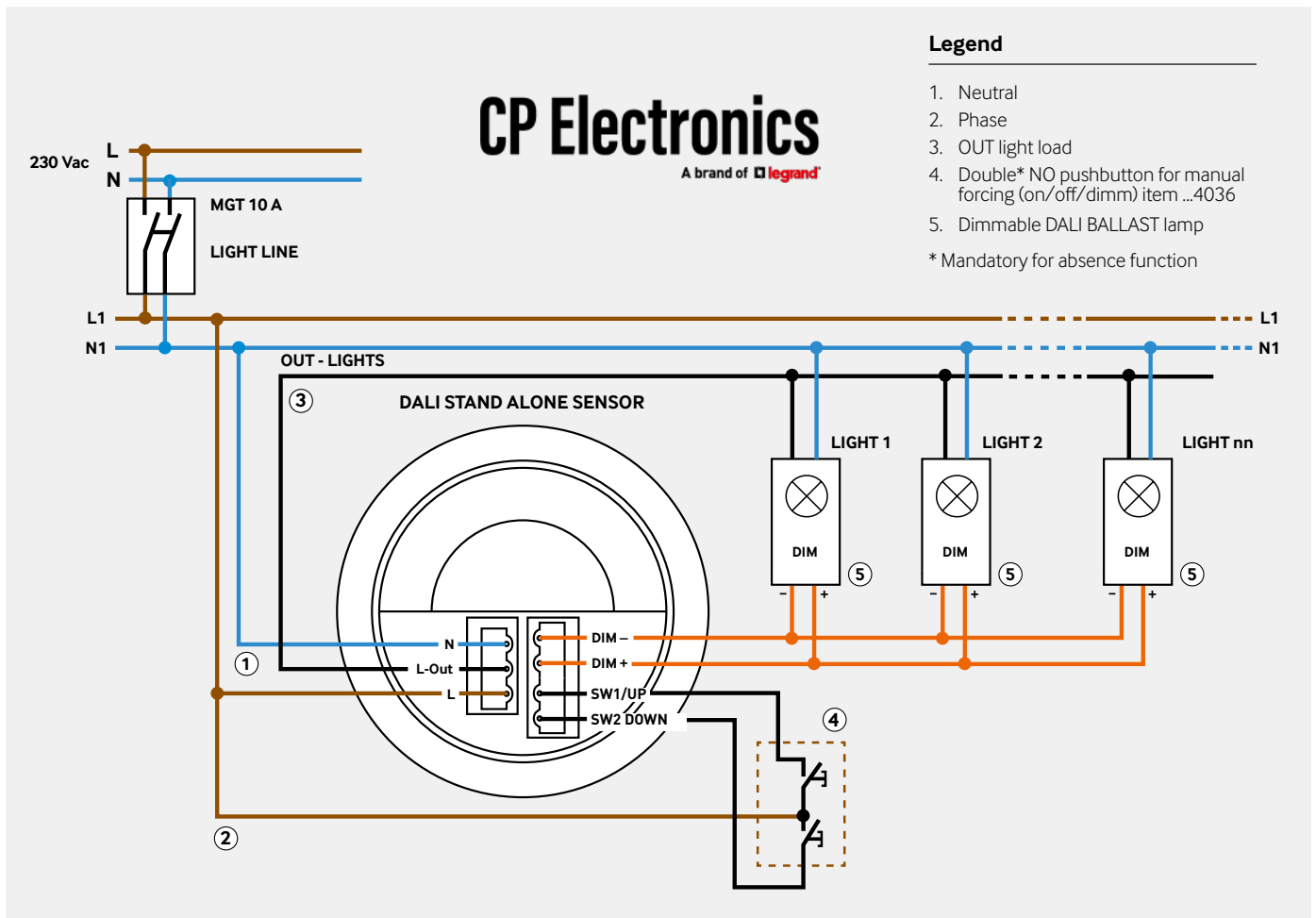

APPLICATION No. 4

Corridor (DALI stand alone)



MANAGEMENT: ON with daylight function - OFF maintaining 20% brightness

DETECTION: presence

APPLICATION DESCRIPTION

Thanks to their reclining head, CP corridor sensors are designed to adapt to any type of environment.

Sensors can be installed at the start/end of the corridor with the head tilted at 90°, or at the centre with the head flat.

The sensor is configured so that when a presence is no longer detected in the corridor, the lighting level switches to a predefined % value. This setting allows for a safe minimum lighting level, so that common areas are not left in complete darkness at night.

The PIR corridor sensor is excellent for narrow corridors and offices with very thin walls (e.g. glazed wall offices). For wider corridors in public places, the microwave sensor is recommended.

SENSOR USED: DALI STAND ALONE

FAMILY: EBDRC

CODE: CP111001



NOTES:

1. Install the sensor away from heat sources.
2. For ceilings up to 2.8 m high, allow for an EBDRC family sensor; for higher ceilings, use a microwave sensor.
3. When using an on-board relay, connect up to 10 DALI ballasts (maximum energy saving), otherwise connect up to a maximum of 20 DALI ballasts.
4. Configuration with daylight function not possible in case of dual-emission lights, i.e. emitting in the direction of the sensor.
5. Presence function configuration is recommended, to ensure optimal lighting levels every time a presence is detected in the environment.
6. When installing the sensor in high ceilings, position the tilting head further towards the floor. This will reduce the range of action but allow for excellent presence detection.

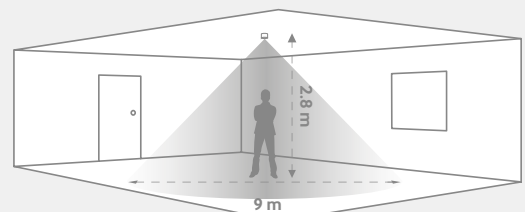

FLOOR PLAN

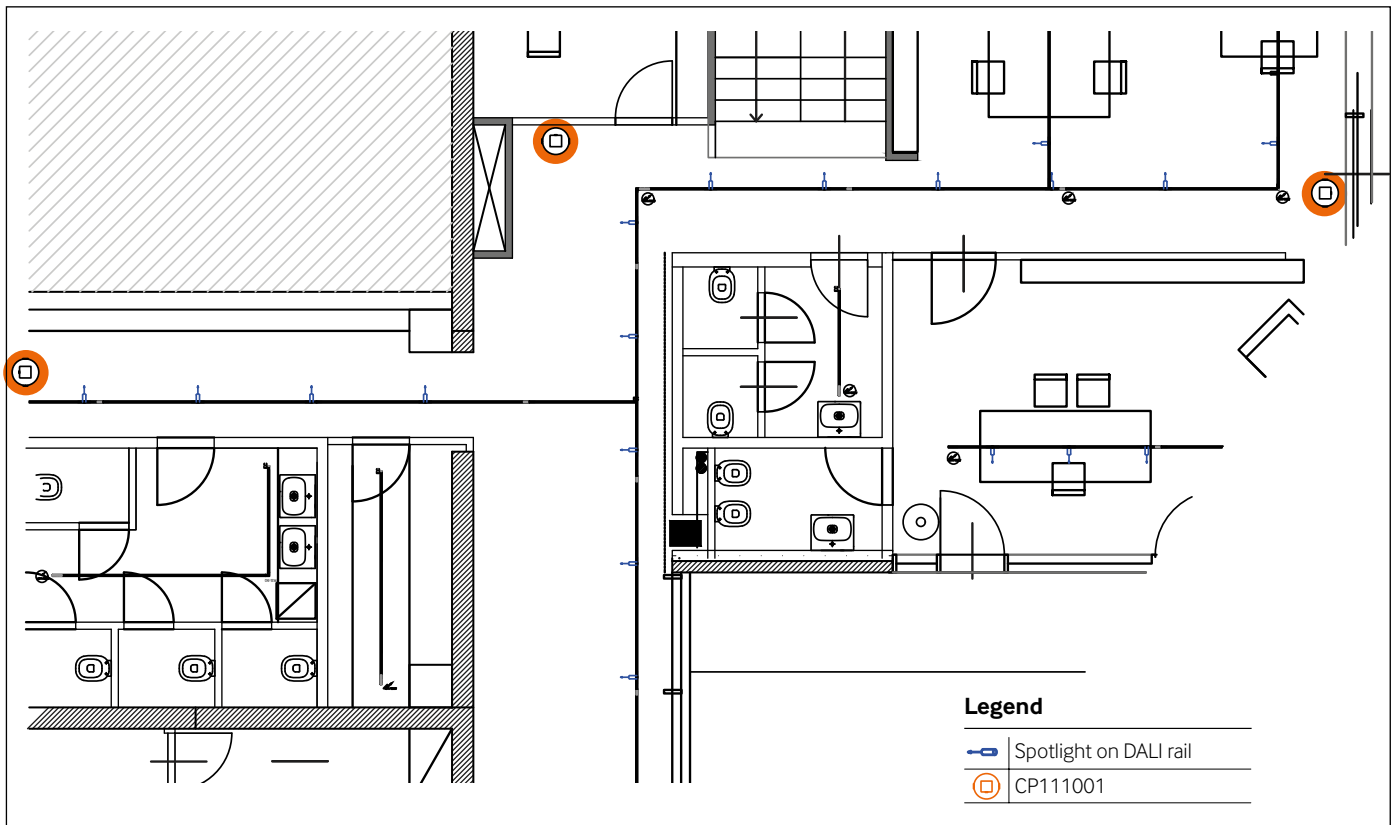

ELECTRIC DIAGRAM

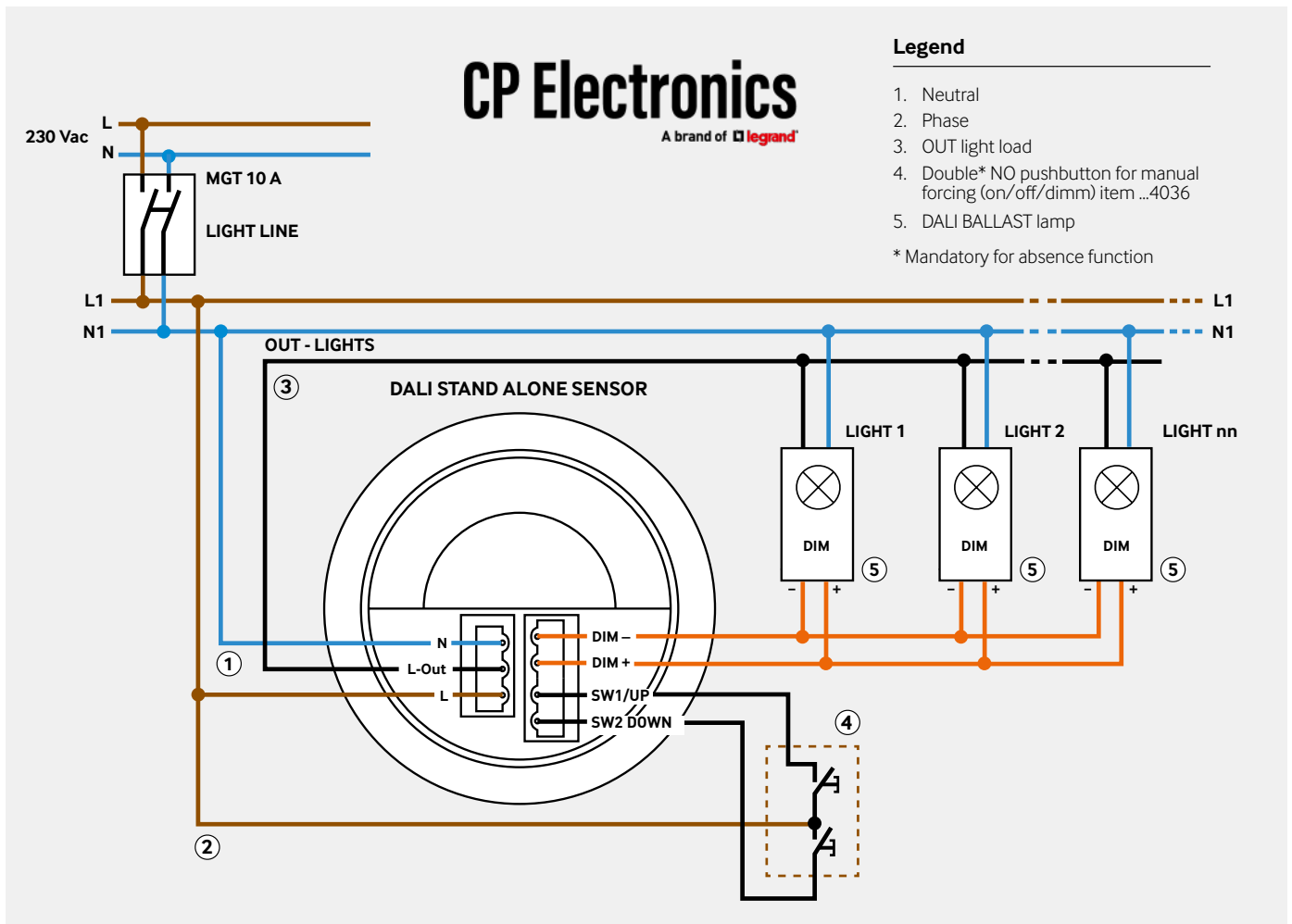

APPLICATION No. 5

Windowless bathroom (stand alone on-off)



MANAGEMENT: ON -OFF - ventilation

DETECTION: presence

APPLICATION DESCRIPTION

A two-channel PIR presence sensor is installed in each windowless bathroom.

The first channel is used to switch the light on and off based on presence, while the second channel is used to drive the ventilation fan.

The parameters of the two channels can be set independently during the configuration, for example by setting a longer delay for turning off the fan.

In case of bathrooms with windows, a minimum threshold (in lux) can be set to control the luminaires depending on the level of natural light, while the ventilation channel can be set to activate the fan as soon as a presence is detected in the room.

SENSOR USED: 2-channel STAND ALONE

FAMILY: EBDSPiR

CODE: CP130039



NOTES:

1. Install the sensor away from heat sources.
2. For ceilings up to 2.8 m high, allow for an EBDSPiR family sensor; for higher ceilings, use a microwave sensor.
3. Presence function configuration is recommended, to ensure optimal lighting levels every time a presence is detected in the environment.
4. Manual forcing using a pushbutton is also possible, although not recommended in order to ensure a higher hygiene level in view of the type of application.

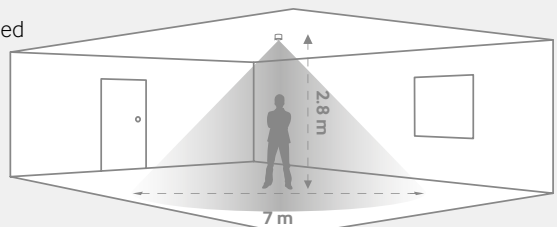

FLOOR PLAN

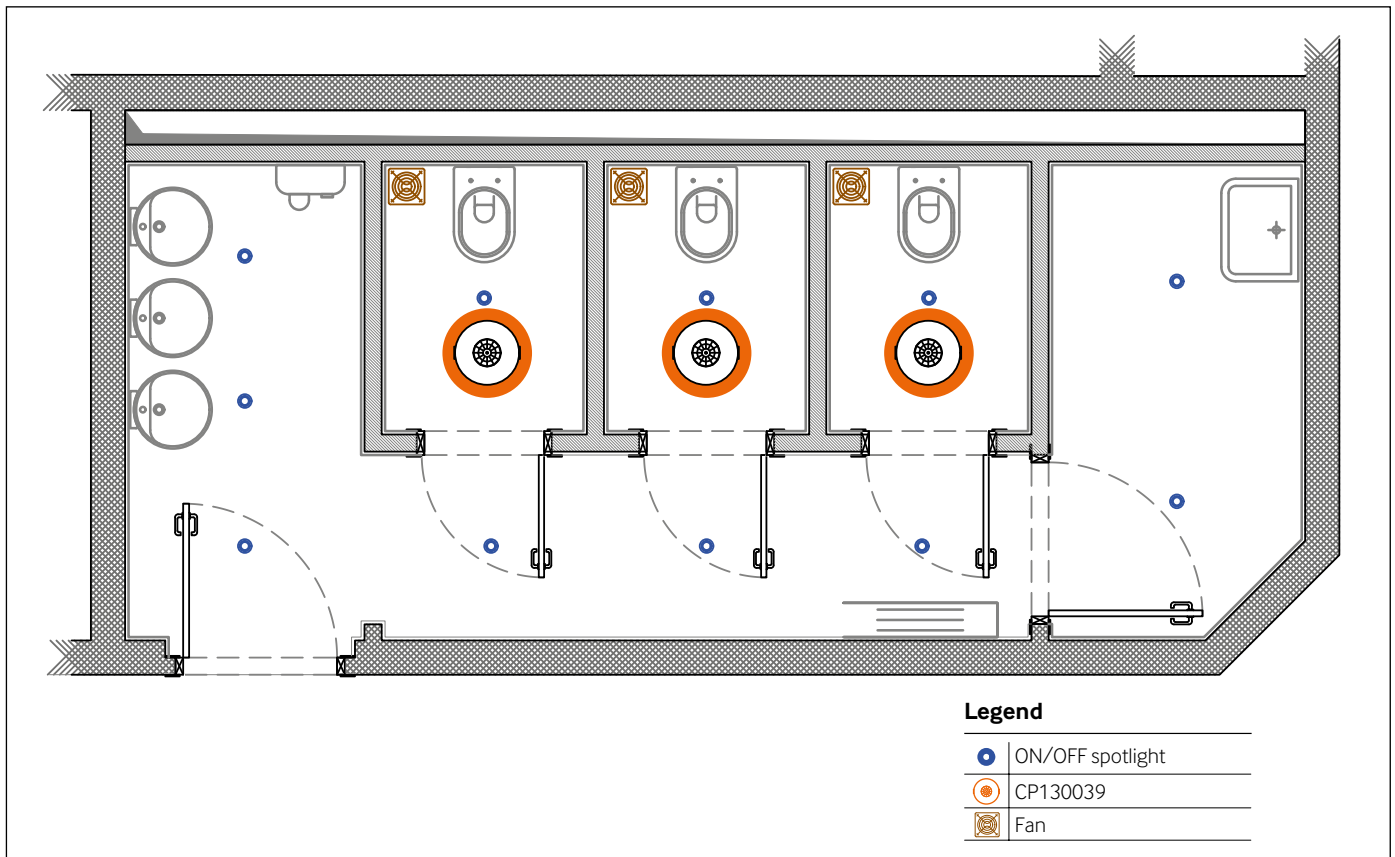

ELECTRIC DIAGRAM

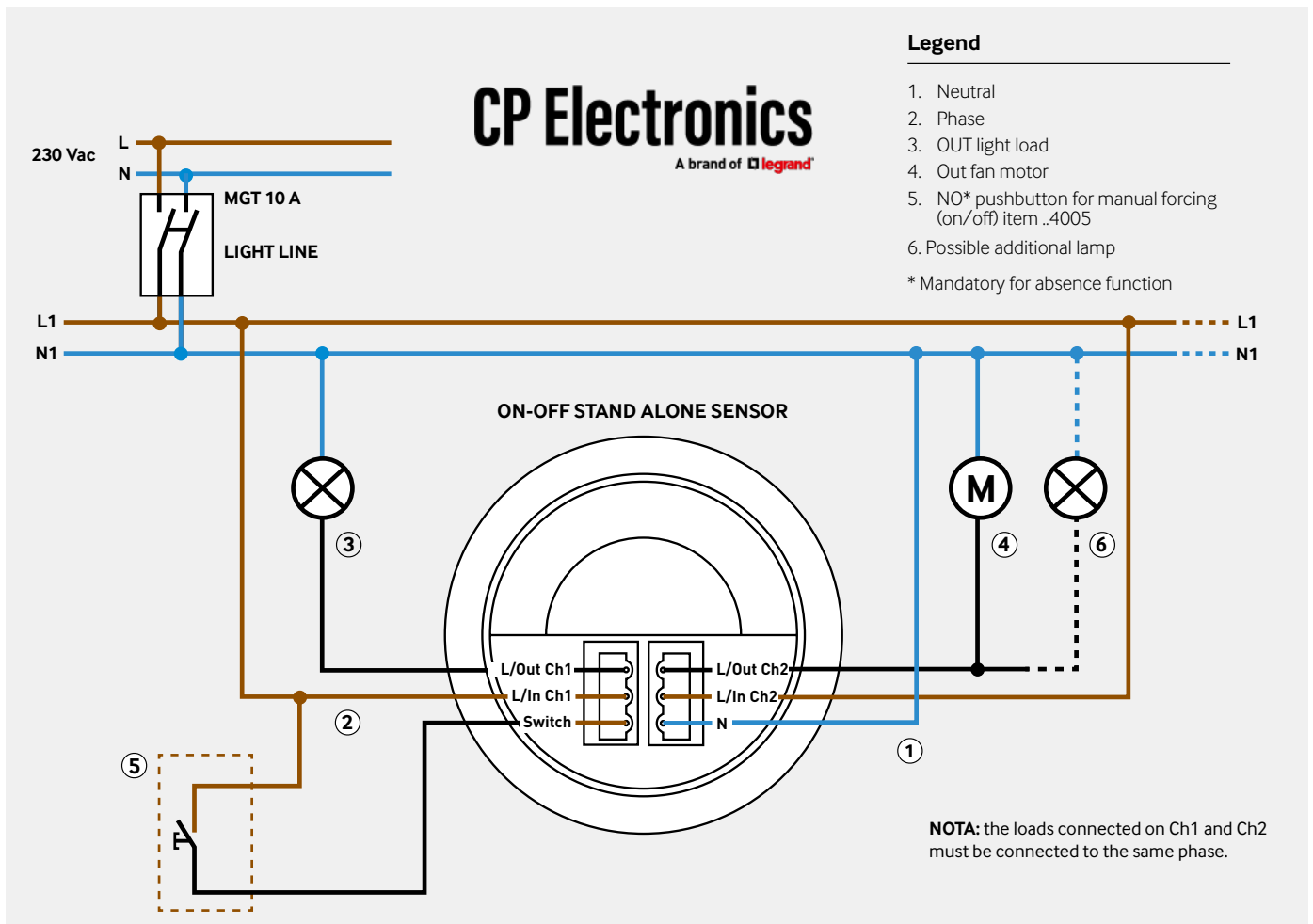

APPLICATION No. 6

Airport - service station toilets (stand alone on-off)



MANAGEMENT: ON -OFF

DETECTION: presence

APPLICATION DESCRIPTION

In bathrooms with partitions, a single high-performance microwave technology sensor can be installed, to cover the entire bathroom area.

For this specific application, either an MWS6 sensor in the centre of the ceiling or MWS3A corridor sensors in peripheral positions are possible.

SENSOR USED: Microwave STAND ALONE

FAMILY: MWS3A

CODE: CP330037



NOTES:

1. Install the sensor away from heat sources.
2. Presence function configuration is recommended, to ensure optimal lighting levels every time a presence is detected in the environment.
3. Manual forcing using a pushbutton is also possible, although not recommended in order to ensure a higher hygiene level in view of the type of application.

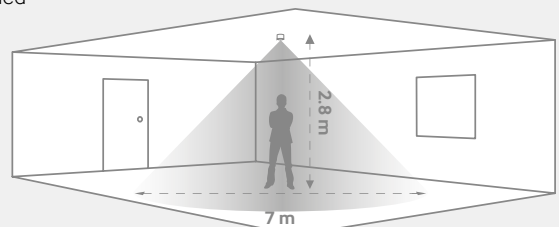

FLOOR PLAN

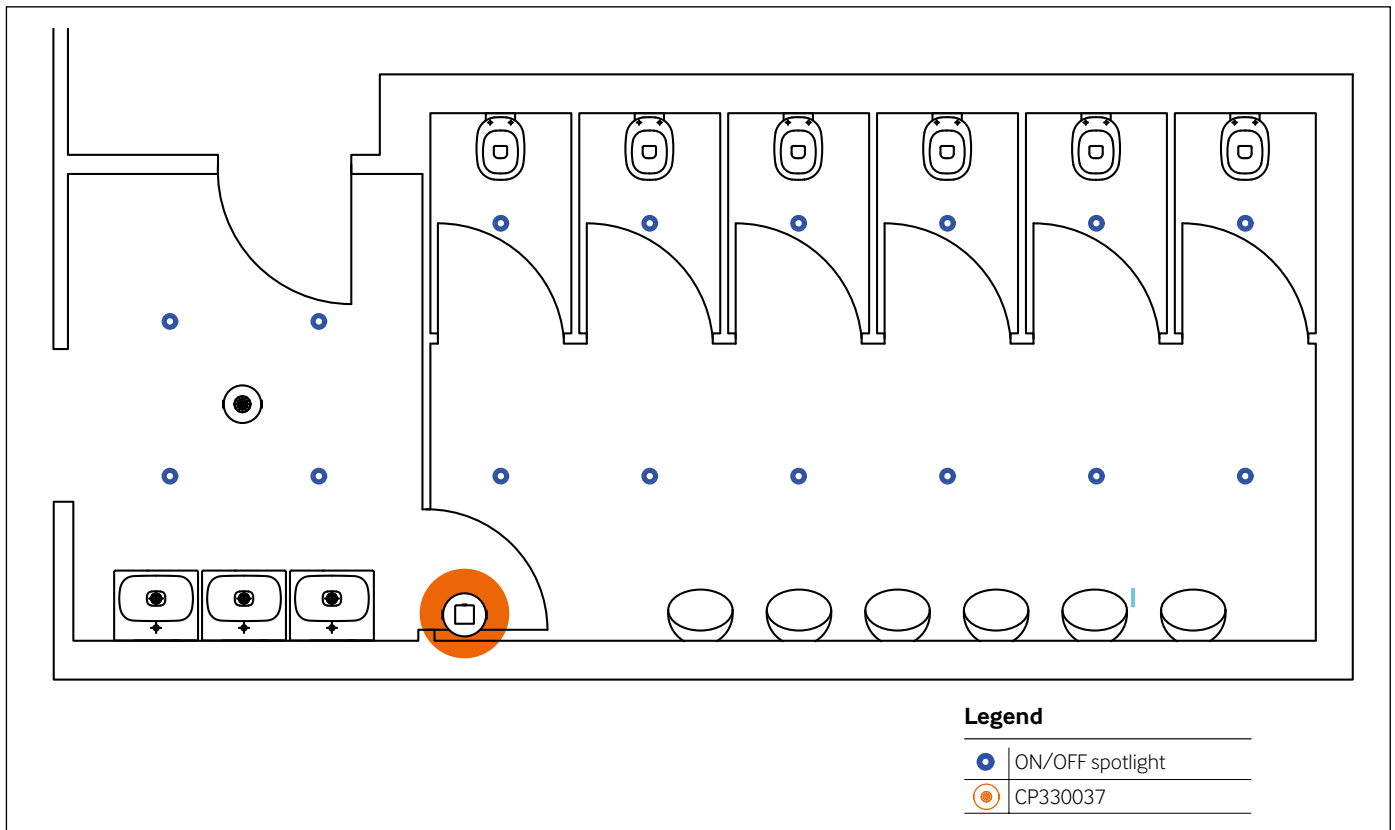

ELECTRIC DIAGRAM

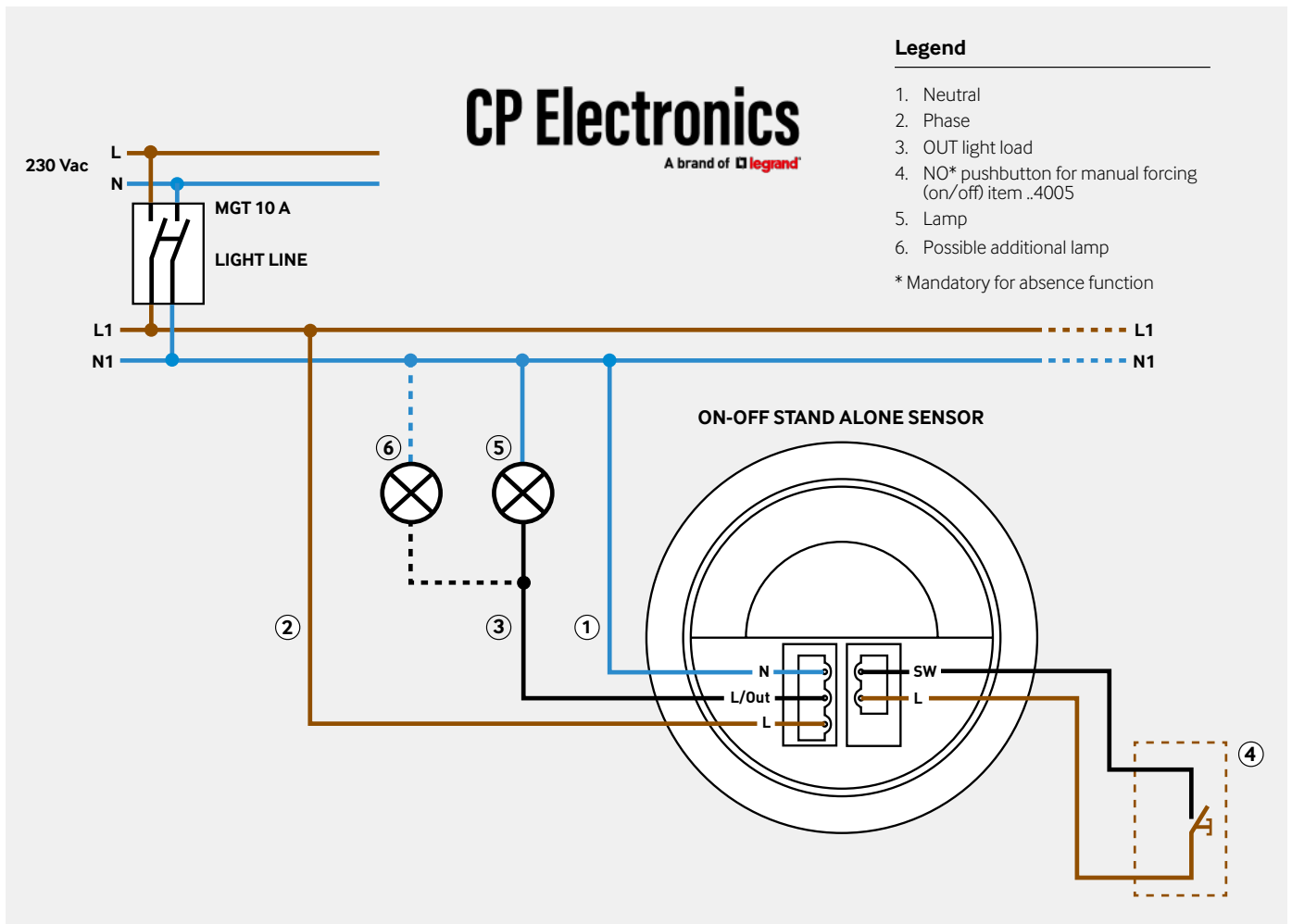

APPLICATION No. 7

Classroom with blackboard (DALI stand alone)



MANAGEMENT: ON/OFF - daylight - manual forcing with pushbutton (also dimming) - presentation scenario

DETECTION: absence

APPLICATION DESCRIPTION

In classrooms, where ceilings are normally high and a large area needs to be covered, the use of microwave technology sensors is recommended. To improve energy savings, it is recommended to configure the sensor for absence detection and daylight function.

The "blackboard" lighting group is the only one connected to the on-board relay. In this way, a pushbutton can be dedicated to manage the dimmer function and a further one to manage the "presentation ON/OFF" scenario.

SENSOR USED: DALI STAND ALONE

FAMILY: MWS6M

CODE: CP360016



NOTES:

1. Install the sensor away from heat sources.
2. Do not install the sensor in rooms higher than 4m.
3. Connect up to 10 DALI ballasts, use the on-board relay to drive the "blackboard" lighting group
4. Configuration with daylight function not possible in case of dual-emission lights, i.e. emitting in the direction of the sensor.
5. Absence function configuration is recommended, to maximise energy savings.
6. It is recommended to use two separate pushbuttons, one for the dimmer function and the other dedicated to the "presentation" scenario.

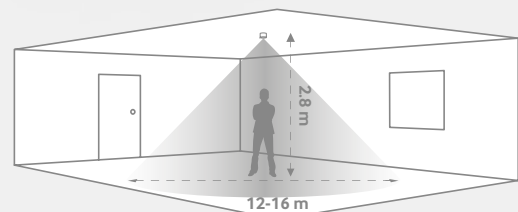

FLOOR PLAN

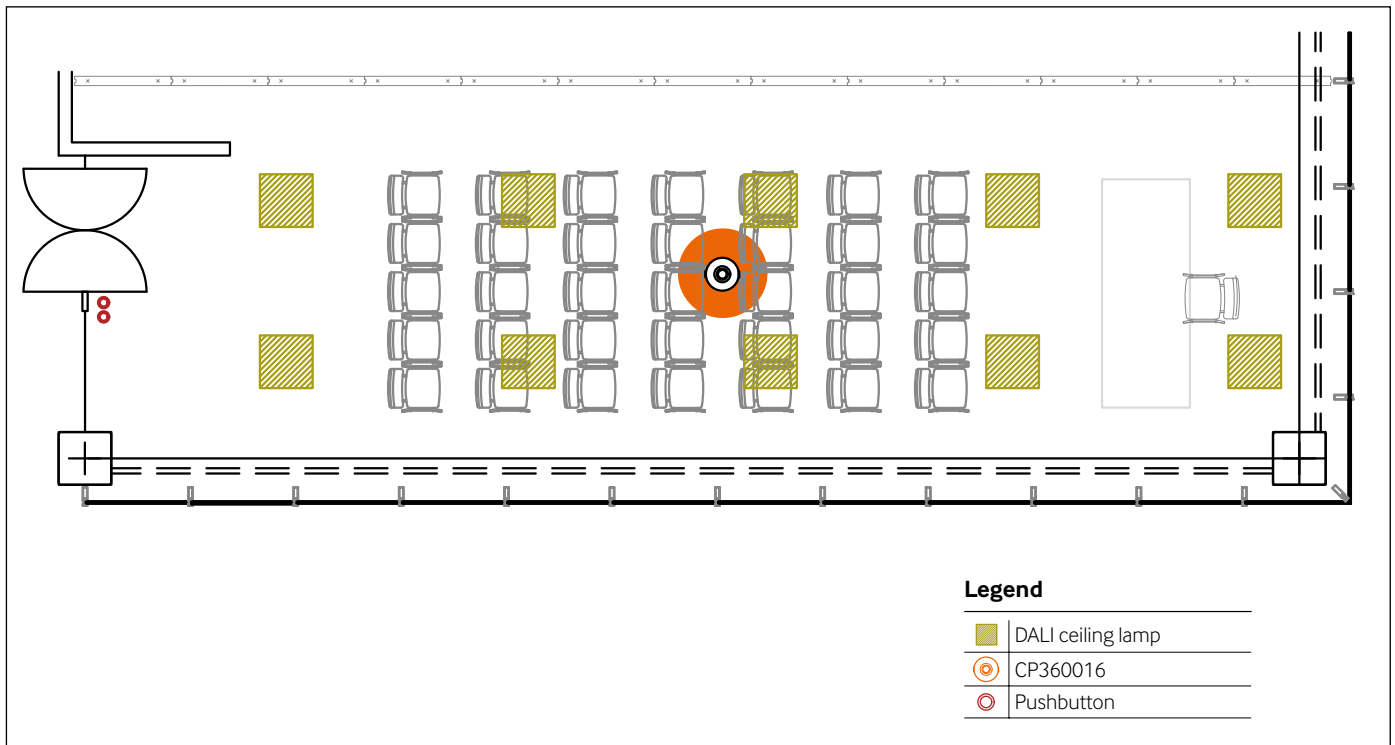

ELECTRIC DIAGRAM

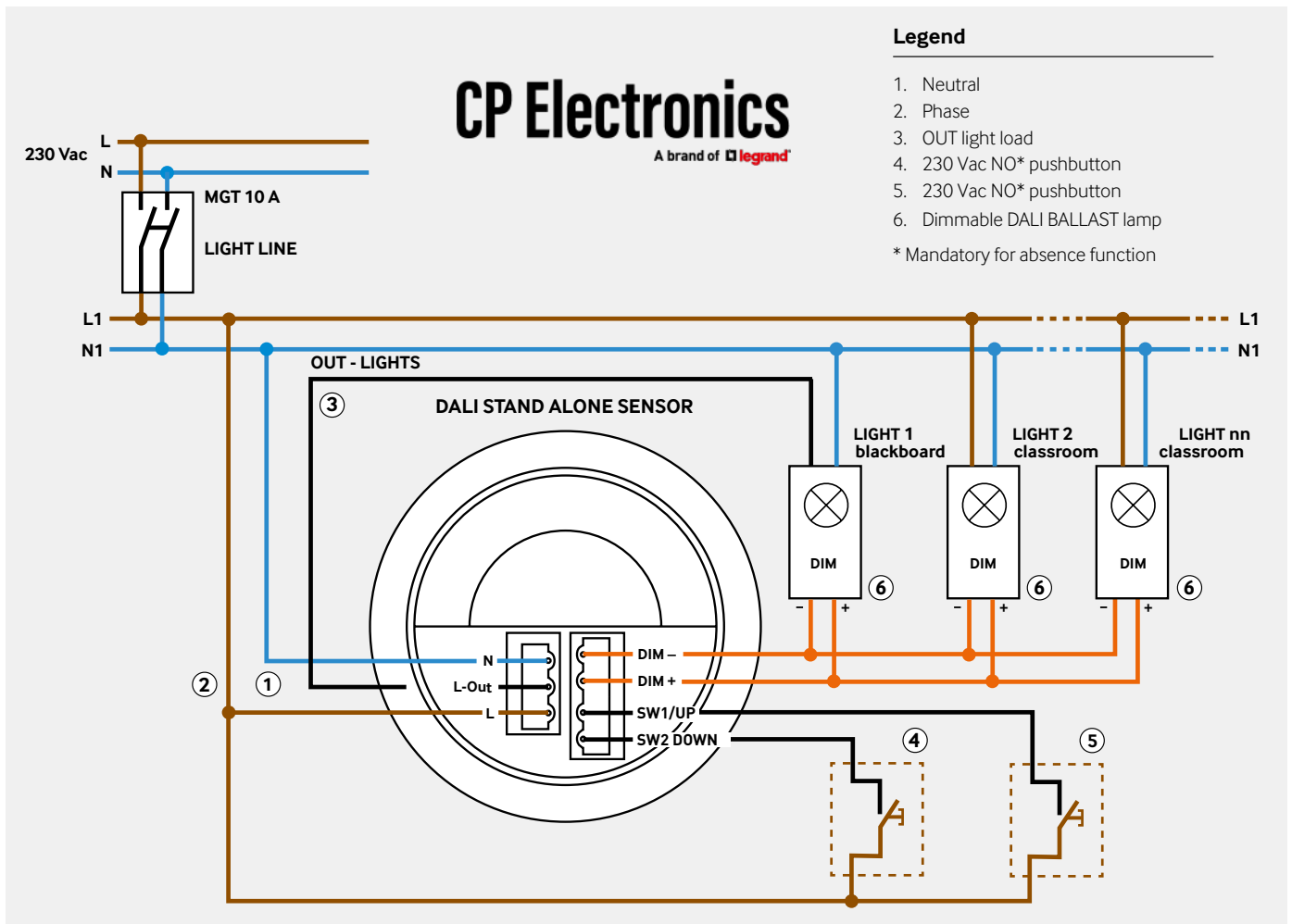

APPLICATION No. 8

Warehouse (DALI stand alone)



MANAGEMENT: daylight

DETECTION: photocell

APPLICATION DESCRIPTION

Warehouses require the use of a sensors suitable for very high bays: the EBDHS sensor can detect to a distance of up to 15m with a coverage diameter of 40m.

Although the sensor is capable of detecting the presence of both people and machines, a photocell configuration is recommended to modulate the lighting according to the level of natural light and ensure energy savings and minimum lighting level on the ground.

Switching on and off could annoy working personnel.

The EBDHS range also includes sensors for installation in environments with temperatures down to -30°C, for refrigerated warehouses.

SENSOR USED: DALI STAND ALONE

FAMILY: EBDHS

CODE: CP100058



NOTES:

1. Install the sensor away from heat sources.
2. During the summer period, the roofs of warehouses reach high temperatures (>35°C), which could interfere with the presence detection.
3. The photocell function is immune to these high temperature issues. For presence detection in warehouses exposed to temperatures >35°, we recommend using a corridor microwave sensor, to create 6 m diameter detection beams (MWS3A family).
4. Photocell function configuration is recommended, to avoid inappropriate switching on and off.
5. If necessary, provide accessories for ceiling installation, even at the highest IP rate.

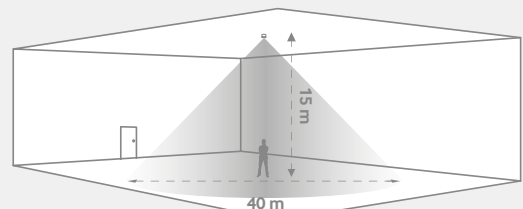

FLOOR PLAN

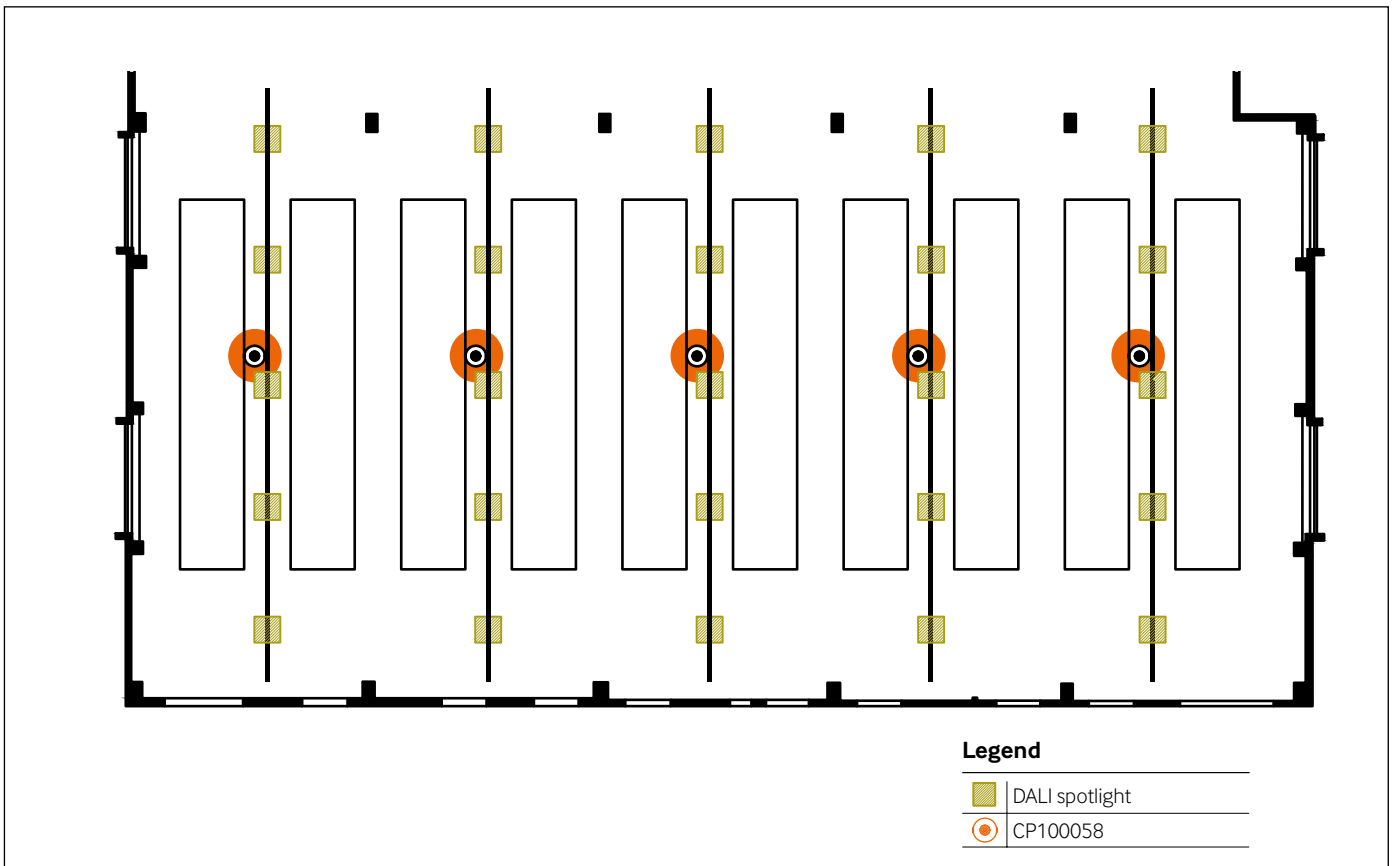

ELECTRIC DIAGRAM

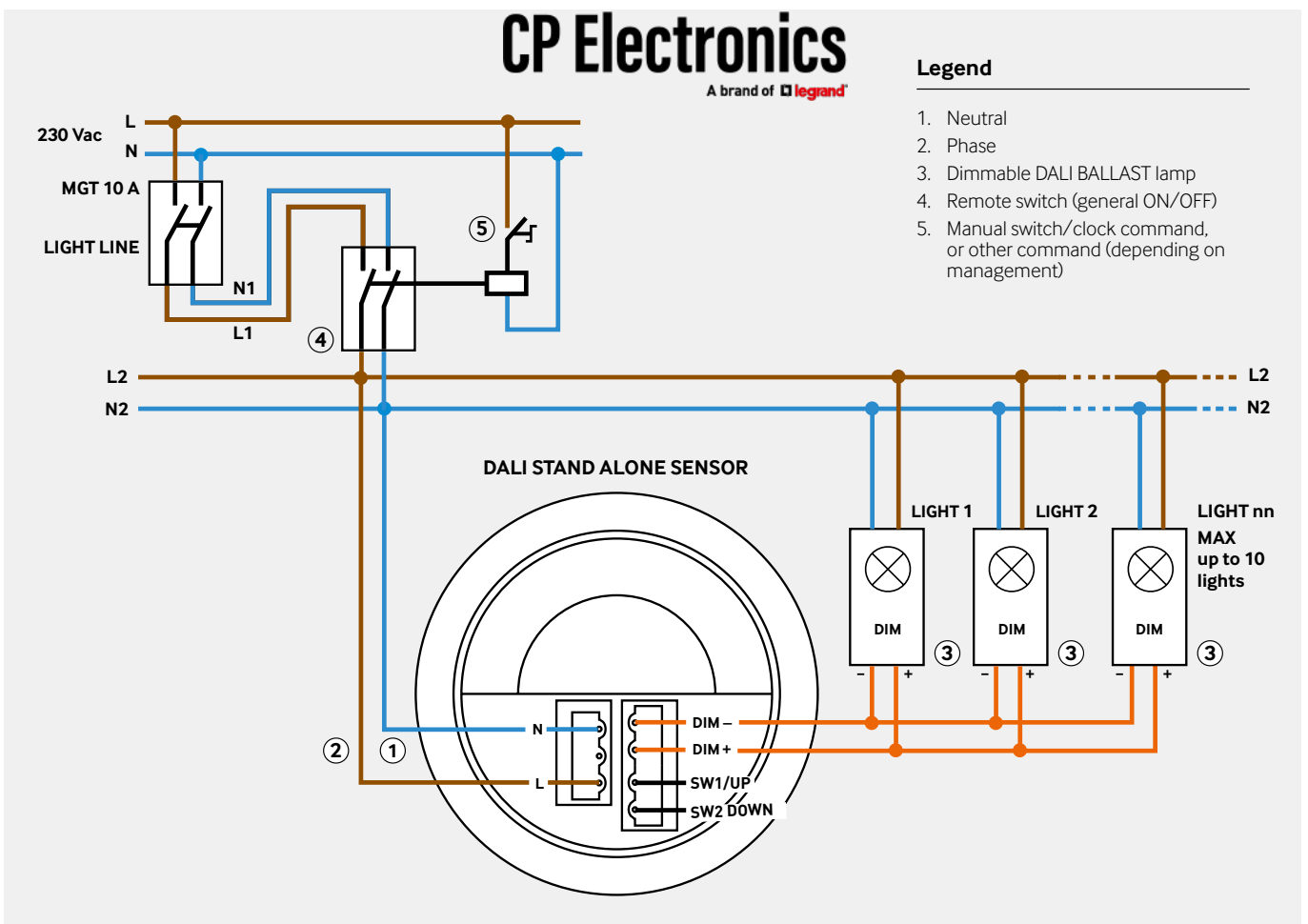

APPLICATION No. 9

Covered car park (stand alone on-off)



MANAGEMENT: ON -OFF -Daylight (ON/OFF)

DETECTION: presence

APPLICATION DESCRIPTION

The MWS1-IP vandal-resistant sensors can be installed on walls or ceilings in environments where a higher IP rate is required (up to IP66)

Parking lanes are considered in the same way as corridors, and the presence of people and cars inside the same is detected by means of a 6 m diameter beam.

The sensor can be installed on the wall at a height of approximately 2m, or in the middle of the lane using brackets (accessory not included in the catalogue). The lights will only be switched on if the amount of natural light is not sufficient to guarantee minimum lighting level on the ground.

No manual forcing is expected.

SENSOR USED: ON-OFF STAND ALONE

FAMILY: MWS1-IP

CODE: CP320015



NOTES:

1. Presence function configuration is recommended, to ensure optimal lighting levels every time a presence is detected in the environment.
2. A specific lux level is guaranteed by means of a luxmeter function, to only switch the system on when necessary.
3. To correctly detect the lux level, tilt the sensor slightly towards the floor.

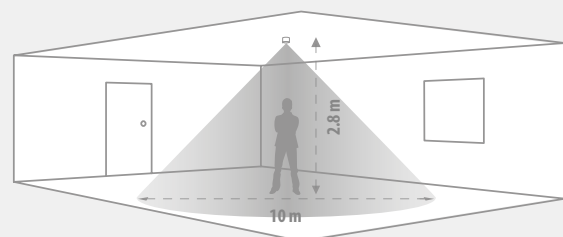

FLOOR PLAN

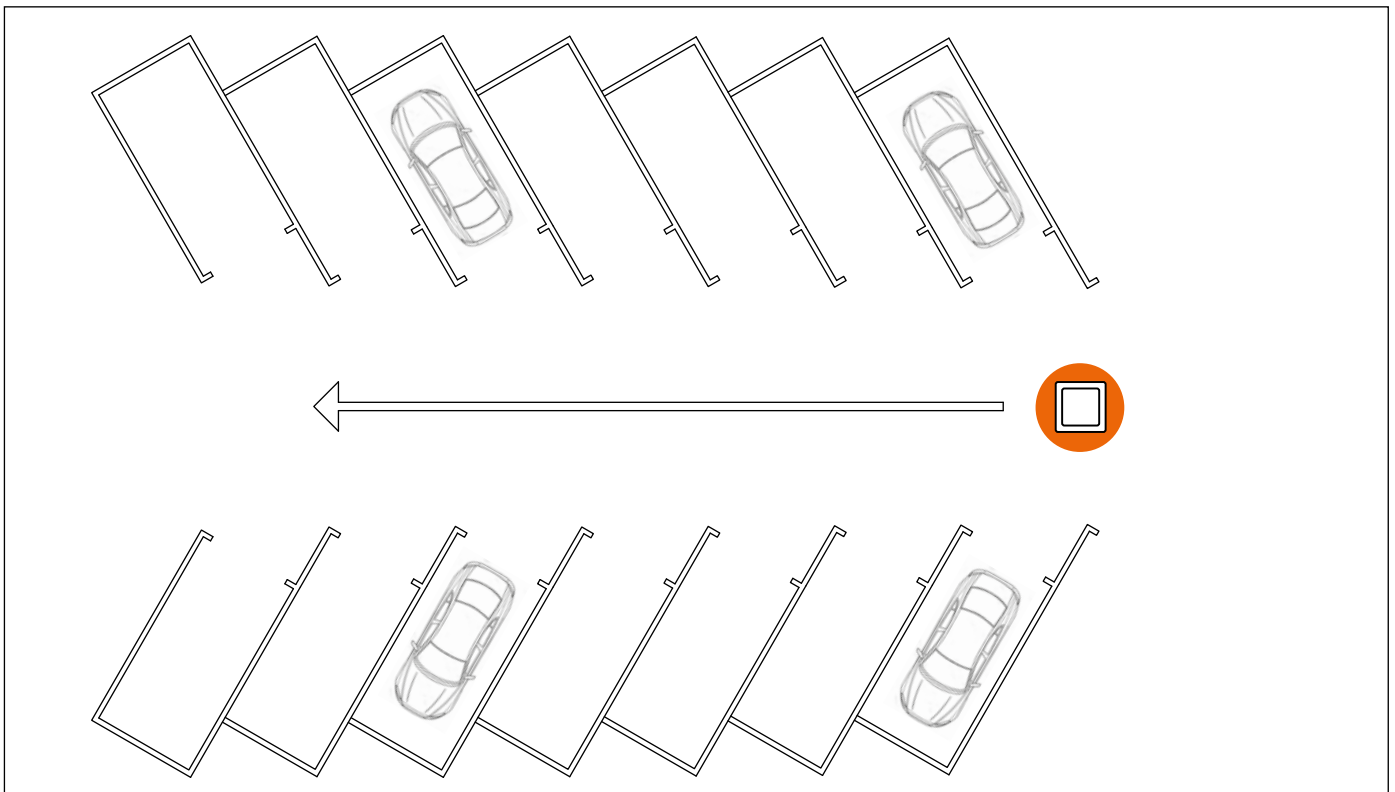

Legend

CP320025

ELECTRIC DIAGRAM

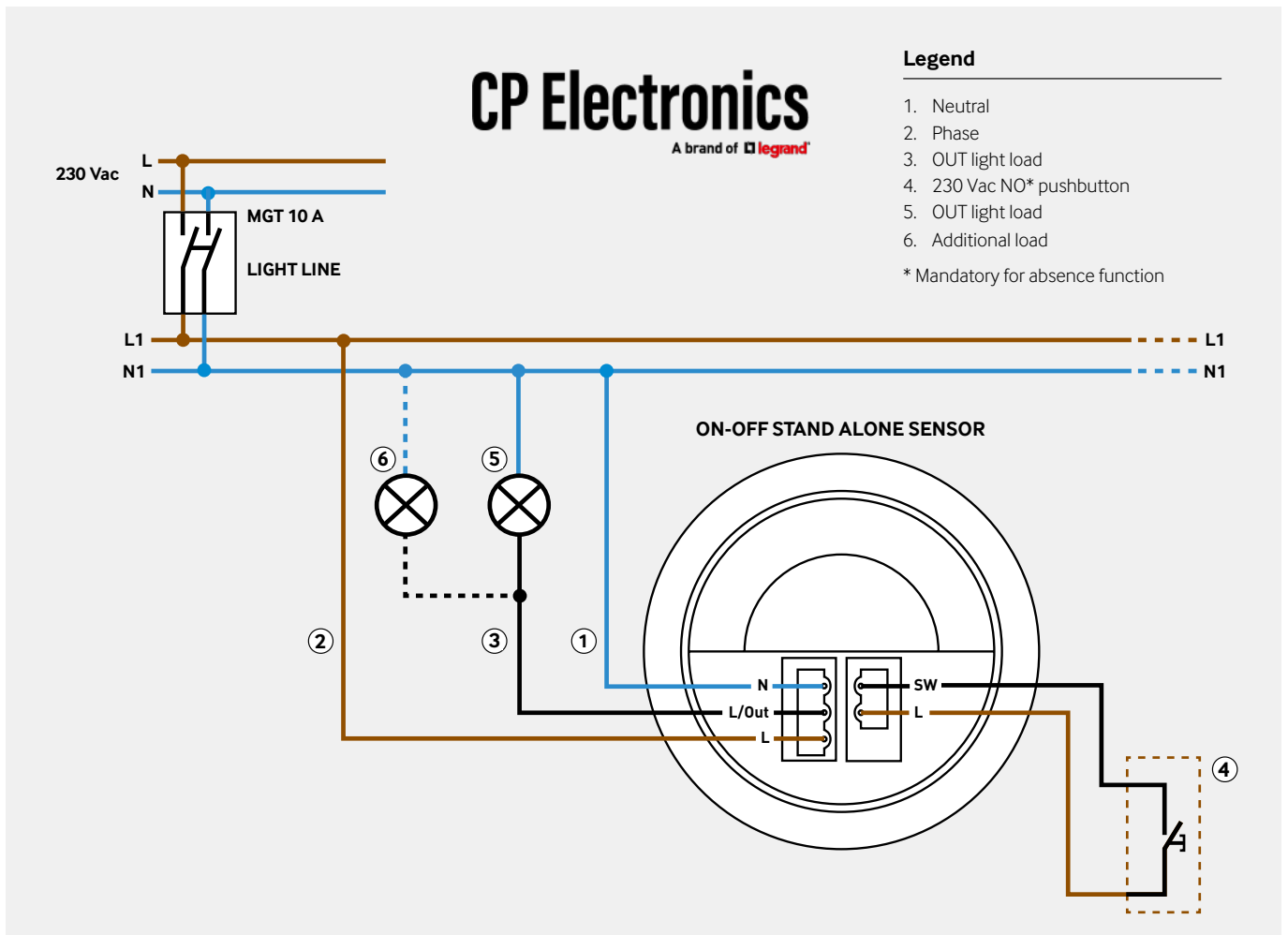

APPLICATION No. 10

Office hall/reception (CASAMBI)



MANAGEMENT:

ON/OFF - daylight - dimming and scenarios

DETECTION: photocell + presence

APPLICATION DESCRIPTION

The sensor is installed at a very high level (halls/receptions are often double-volume) and during working hours, from 7 a.m. to 7 p.m., ensures a standard lighting level thanks to the daylight function.

During the remaining hours of the night, a minimum lighting level and the presence detection function are guaranteed.

Scenarios controlled by the Casambi APP are set, allowing the system to be switched on at 100%, or to create special combinations in the case of important guests.

The sensor controls the directly wired lights (to the relay terminals and/or the DALI terminals) and can also control properly configured Casambi lights.

SENSOR USED: CASAMBI

FAMILY: EBDHS

CODE: CP100053



NOTES:

1. Install the sensor away from heat sources.
2. Photocell function configuration is recommended, to avoid inappropriate switching on and off during daytime hours.
3. Connect up to 10 DALI ballasts.
4. Configuration with daylight function not possible in case of dual-emission lights, i.e. emitting in the direction of the sensor.
5. Controllable using the Casambi APP.
6. The functions described are guaranteed and managed by the CASAMBI technology and may vary over time.

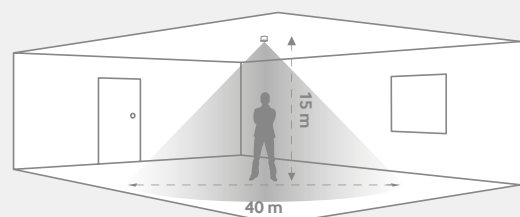

FLOOR PLAN

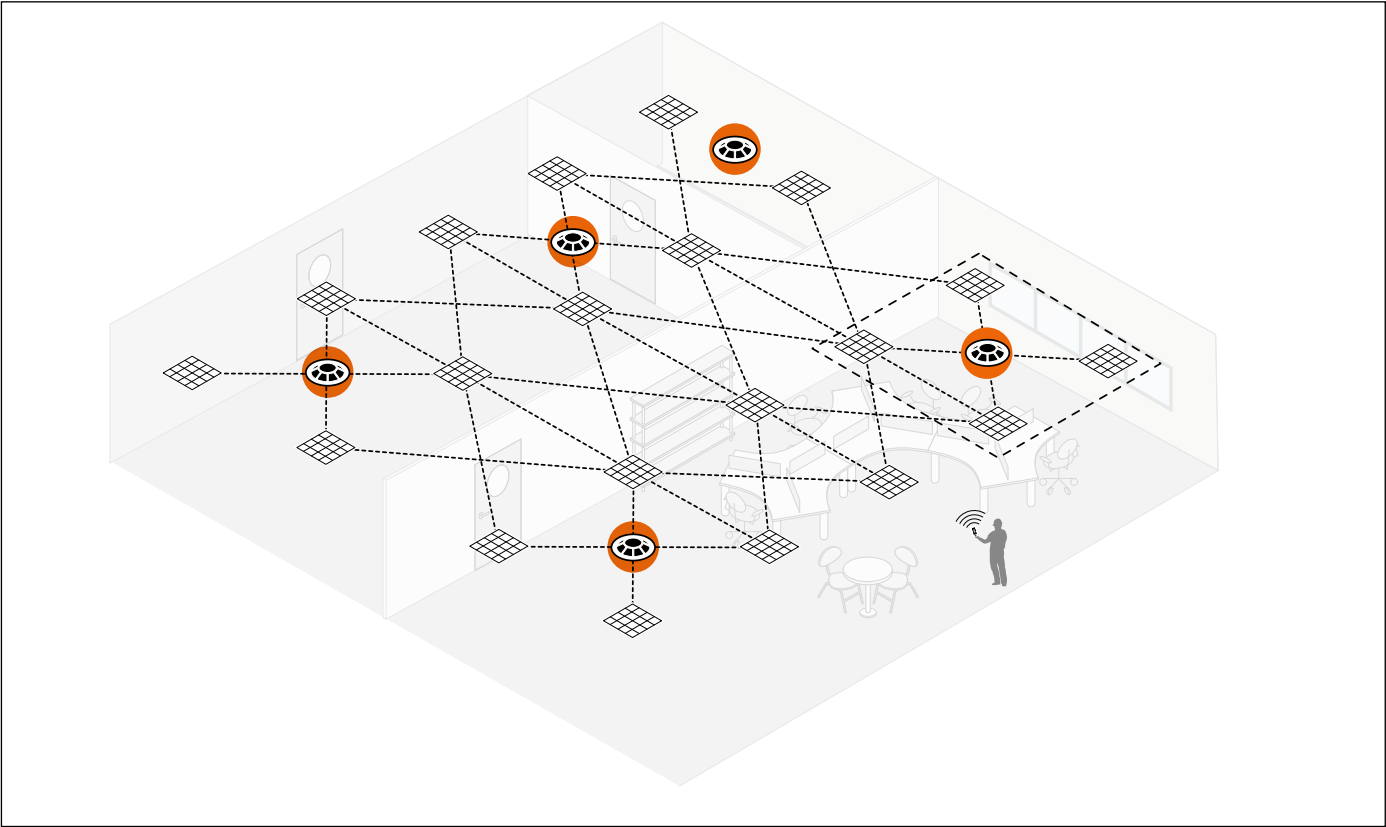

ELECTRIC DIAGRAM

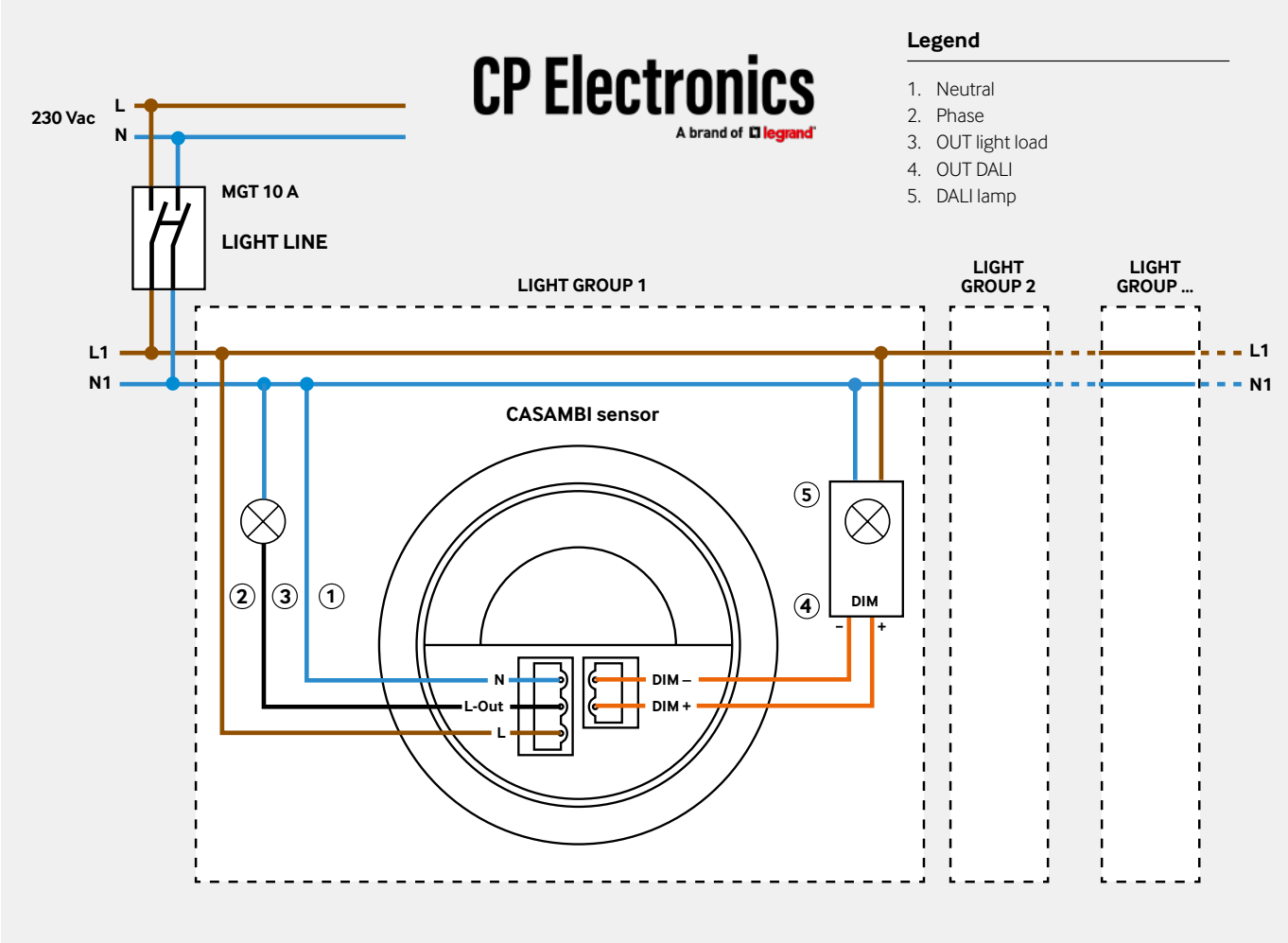

APPLICATION No. 11

Solution to manage the whole building (KNX)



MANAGEMENT: integrated and programmable

DETECTION: absence/presence

APPLICATION DESCRIPTION

To manage lighting systems when supervision or control scenarios are required, the most flexible solution is to manage presence and lux using KNX sensors and control ON/OFF actuators, dimmers or KNX/DALI gateways, depending on the luminaires.

CP sensors with KNX technology can receive commands from two conventional SELV-connected pushbuttons on the rear terminals.

The sensors are directly powered by the KNX bus, reducing system costs.

The range of CP sensors includes PIR sensors for offices (EBDSPIR), for corridors (MWS3A), for open-plan offices or large rooms (MWS6) and for high ceiling areas (EBDHS).

SENSOR USED: KNX

FAMILY: EBDSPIR-EBDHS-MWS6-MWS3A



NOTES:

1. Install the sensor away from heat sources.
2. For ceilings up to 2.8 m high, allow for an EBDSPIR family sensor; for higher ceilings, use a microwave sensor.
3. Configuration with daylight function not possible in case of dual-emission lights, i.e. emitting in the direction of the sensor.
4. Absence function configuration is recommended, to maximise energy savings and avoid unnecessary switching on. The presence function is recommended in service and common areas.
5. For the manual forcing of the lights, traditional civil series controls can be used through the contact interface, item 002692.
6. The configuration of sensors and all the other KNX devices is completed using the ETS software (also with simple presets).

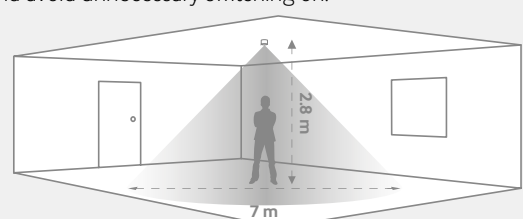

EXAMPLE WIRING DIAGRAM

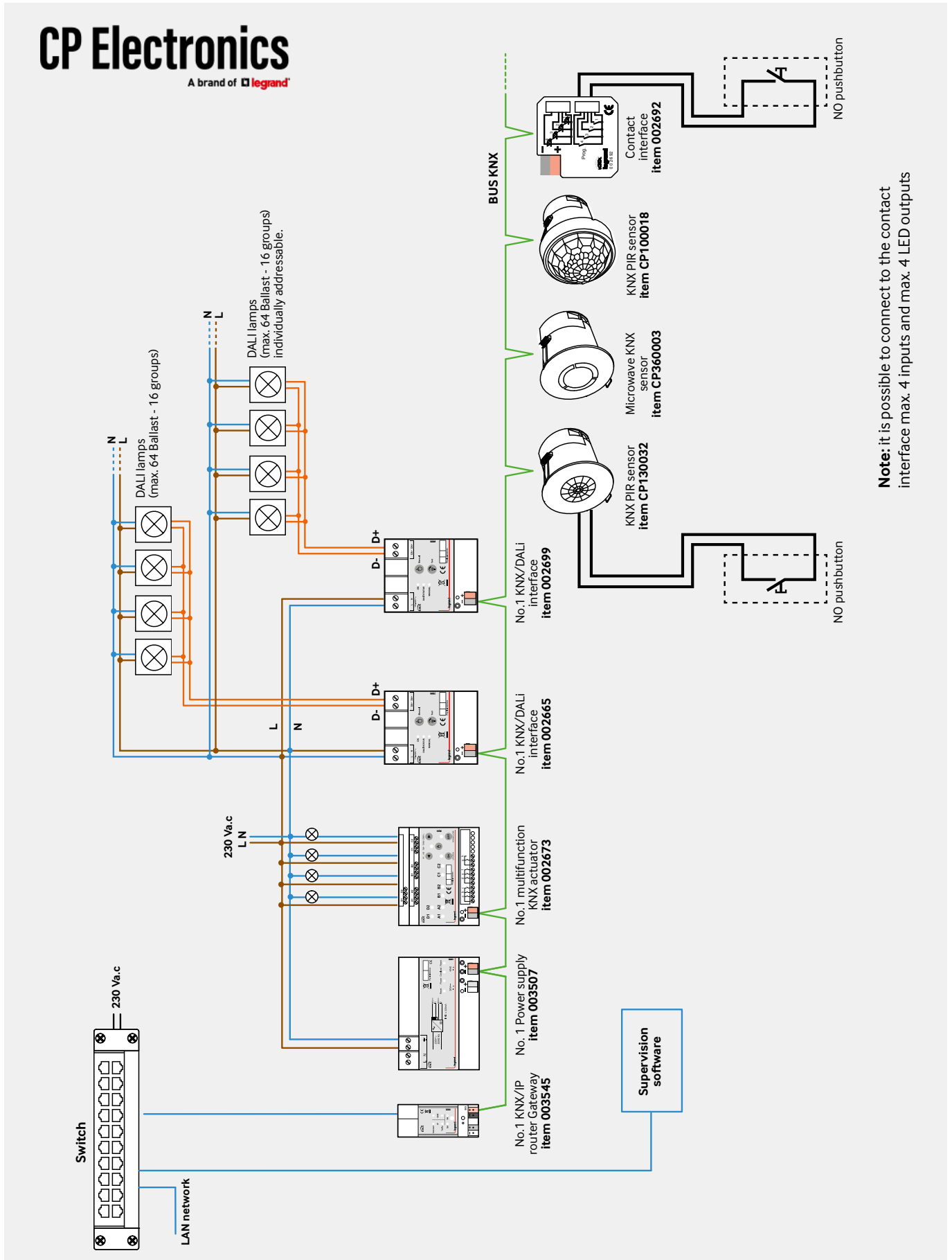



CP Electronics
A brand of  **legrand**

Contents

Catalogue

PIR presence/absence sensors	84
MW presence/absence sensors	89
Presence/absence sensors in Casambi technology	93
Presence/absence sensors in KNX technology	93
Installation accessories	94
Configuration gateway and remote control	95



EBDSPIR - series



EBDSM - series

PIR (passive infrared) sensors

Supplied with standard configuration for a simple and easy commissioning
The maximum contact current value (in A) indicated in the item description is valid for compact fluorescent lamps and LED lamps.

Connection 1 x 2.5 mm² or 2 x 1.5 mm²

- With 1 or 2 inputs for pushbutton control
- Possible use also as absence detector with pushbutton switching on
- Light intensity adjustment based on the natural light
- Minimum adjustable brightness level (for example in corridors)
- Programming via configuration Gateway (088240) and SmartBeam app
- Control using the IR remote control (CP460007)
- The DALI/1-10 V versions have 2 independent channels: 1 dimmer channel and 1 communication channel
- Time settings: from 10 seconds to 99 minutes
- Ceiling surface/flush mounting using accessories

Item **COMPACT PIR SENSORS, CEILING FLUSH MOUNTING**

EBDSPIR

Flat PIR sensors for ceiling mounting.
Detection 360°, range ø 7 m with recommended fixing height: 2.8 m. IP 40

CP130038	ON/OFF 10 A
CP130039	ON/OFF 6 A 2 outputs
CP130042	ON/OFF 6 A 2 NC outputs (Fail Safe)
CP130045	ON/OFF 10 A IP 55
CP130046	ON/OFF 10 A IP 55 -30 °C
CP130048	ON/OFF 3 A 12-24 V AC/DC
CP130052	ON/OFF 3 A 1 x NA/NC
CP130005	1-10 V 10 A analog dimmer
CP130007	1-10 V 10 A IP 55 -30 °C analog dimmer
CP130018	DALI 10 A digital dimmer
CP130021	DALI 10 A IP 55 -30 °C digital dimmer
CP130022	DALI 3 A 12-24 V AC/DC digital dimmer

COMPACT PIR SENSORS, CEILING SURFACE MOUNTING

EBDSM

PIR sensors for ceiling mounting. 360° detection.
Range ø 7 m. Recommended fixing height: 2.8 m
IP 40 / IP 54

CP120002	ON/OFF 10 A
CP120000	1-10 V 10 A analog dimmer
CP120001	DALI 10 A digital dimmer

Detection zone and dimensions

EBDSPIR



Detection zone

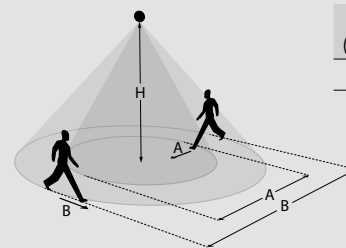

H (Height)	A (Diameter)	B (Diameter)
3 m	5 m	8 m
2.8 m	4.5 m	7 m

Dimensions (mm)

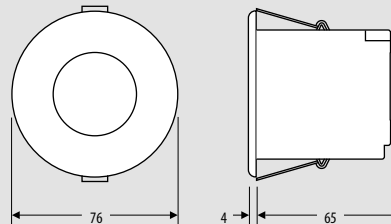

EBDSM

Detection zone

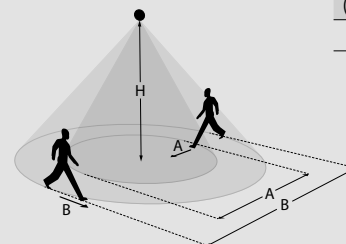

H (Height)	A (Diameter)	B (Diameter)
3 m	5 m	8 m
2.8 m	4.5 m	7 m

Dimensions (mm)

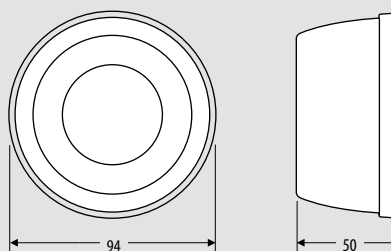

PIR presence/absence sensors

Mid range



EBDMR - series

PIR (passive infrared) sensors

Supplied with standard configuration for a simple and easy commissioning

The maximum contact current value (in A) indicated in the item description is valid for compact fluorescent lamps and LED lamps.

Connection 1 x 2.5 mm² or 2 x 1.5 mm²

- The DALI/1-10 V versions have 2 independent channels:
1 dimmer channel and 1 on/OFF channel
- Designed for open plan offices where a wide detection area is required
- 1 or 2 inputs for pushbutton control
- Possible use also as absence detector with pushbutton switching on
- Light intensity adjustment based on the natural light
- Minimum adjustable brightness level (for example in corridors)
- Programming via configuration Gateway (088240) and SmartBeam app
- Control using the IR remote control (CP460007)
- Time settings: from 10 seconds to 99 minutes
- Ceiling surface/flush mounting using accessories

Item **COMPACT PIR SENSORS, CEILING FLUSH MOUNTING, MID RANGE.**

EBDMR

PIR sensors for ceiling mounting
Detection 360°. Range ø 15 m.
Recommended fixing height: 2.8 m
IP 40

CP110000	ON/OFF 10 A
CP110002	1-10 V 10 A analog dimmer
CP110001	DALI 10 A digital dimmer

Detection zone and dimensions

EBDMR



Detection zone

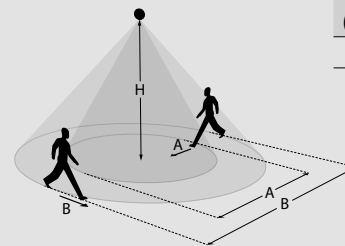

H (Height)	A (Diameter)	B (Diameter)
3 m	6.5 m	16 m
2.8 m	6 m	15 m

Dimensions (mm)

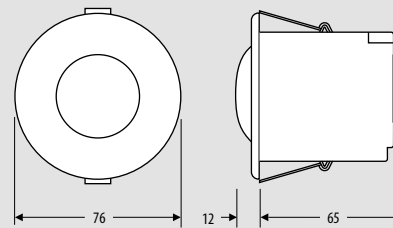



EBMHS-series

EBMPIR - series

PIR (passive infrared) sensors

Supplied with factory configuration for a simple and easy commissioning
The maximum contact current value (in A) indicated in the item description is valid for compact fluorescent lamps and LED lamps.
Connection 1 x 2.5 mm² or 2 x 1.5 mm²

- The DALI/1-10 V versions have 2 independent channels:
- 1 dimmer channel and 1 on/OFF channel
- With 1 or 2 inputs for pushbutton control
- Possible use also as absence detector with pushbutton switching on
- Light intensity adjustment based on the natural light
- Minimum adjustable brightness level (for example in corridors)
- Programming via configuration Gateway (088240) and SmartBeam app
- Control using the IR remote control (CP460007)
- Time settings: from 10 seconds to 99 minutes
- Flush mounting or luminaire mounting

Item	MINIATURE PIR SENSORS, CEILING FLUSH MOUNTING
	EBMHS
	Miniature PIR presence detectors for ceiling mounting using a perforated control module
	Detection 360°, range ø 9-16 m
	Fixing height: from 2.8 to 7 m
	IP 40
CP140024	ON/OFF 3 A
CP140002	1-10 V 3 A analog dimmer
CP140010	DALI 3 A digital dimmer

	MINIATURE PIR SENSORS, LUMINAIRE MOUNTING
	EBMPIR-MB
	Retrofit sensor on support
	Mounting on M20
	Detection 360°, range ø 9-16 m
	Fixing height: from 2.8 to 7 m
	IP 65
	Supplied with connection cables, about 1 m
CP160023	Retrofit sensor - ON/OFF 2 A IP 65
CP160016	Retrofit sensor - analog dimmer 1-10 V 2 A
CP160020	Retrofit sensor - digital dimmer DALI - 2 A

Detection zone and dimensions

EBMHS



Detection zone

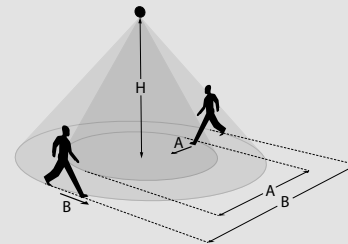

H (Height)	A (Diameter)	B (Diameter)
7 m	10 m	16 m
3 m	5.5 m	10 m
2.8 m	5 m	9 m

Dimensions (mm)

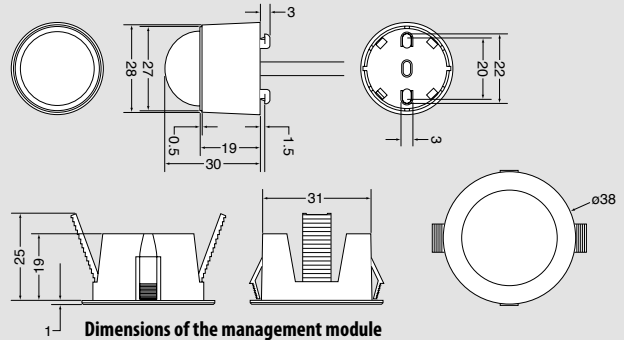

EBMPIR-MB

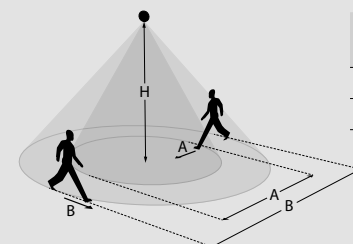

H (Height)	A (Diameter)	B (Diameter)
7 m	10 m	16 m
3 m	5.5 m	10 m
2.8 m	5 m	9 m

Dimensions (mm)

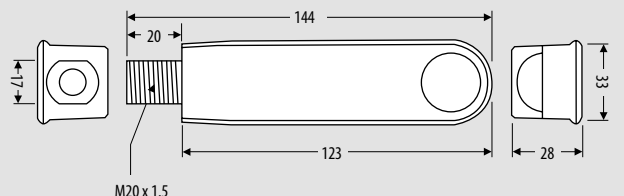

PIR presence/absence sensors for very high rooms



CP100057

CP100063

PIR (passive infrared) sensors

Supplied with factory configuration for a simple and easy commissioning
The maximum contact current value (in A) indicated in the item description is valid for compact fluorescent lamps and LED lamps.
Connection 1 x 2.5 mm² or 2 x 1.5 mm²

- Designed for very high rooms
- The DALI/1-10 V versions have 2 independent channels:
1 dimmer channel and 1 on/off channel
- Possible use also as absence detector with pushbutton switching on
- Light intensity adjustment based on the natural light
- Minimum adjustable brightness level (for example in corridors)
- Programming via configuration Gateway (088240) and SmartBeam app
- Control using the IR remote control (CP460007)
- Supplied with masking clips for detection zone adjustment
- Time settings: from 10 seconds to 99 minutes
- Flush mounting or luminaire mounting

Item **PIR SENSORS, FLUSH MOUNTING FOR VERY HIGH ROOMS (HIGH BAY)**

EBDHS

PIR sensors for high ceilings
Detection 360°, range ø 40 m with recommended fixing height: 15 m
Adjustable detection zone (masking supplied)
With 1 or 2 inputs for pushbutton control

CP100057	ON/OFF 10 A, IP 40
CP100059	analog dimmer 1-10 V 10 A, IP 40
CP100058	digital dimmer DALI 10 A, IP 40

PIR SENSORS, LUMINAIRE MOUNTING FOR VERY HIGH ROOMS (HIGH BAY)

EBDHS-MB

Retrofit sensors for high ceilings
M20 mounting on luminaires
Detection 360°, range ø 40 m
Adjustable detection zone, masking supplied
Supplied with connection cables, about 1 m
IP 65 - 2A

CP100063	ON/OFF
CP100065	1-10 V analog dimmer
CP100064	DALI digital dimmer

Detection zone and dimensions

EBDHS



Detection zone

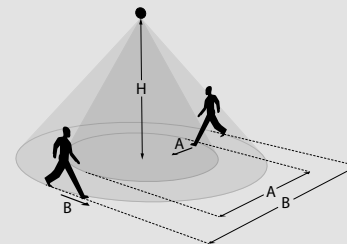

H (Height)	A (Diameter)	B (Diameter)
20 m	32 m	42 m
15 m	30 m	40 m
10 m	20 m	26 m
6 m	12 m	16 m
3 m	6 m	8 m

Dimensions (mm)

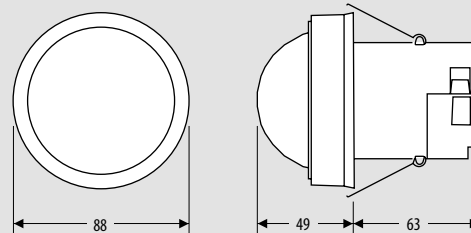

EBDHS-MB



Detection zone

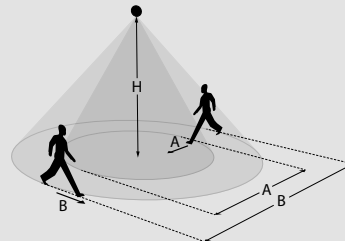

H (Height)	A (Diameter)	B (Diameter)
20 m	32 m	42 m
15 m	30 m	40 m
10 m	20 m	26 m
6 m	12 m	16 m
3 m	6 m	8 m

Dimensions (mm)

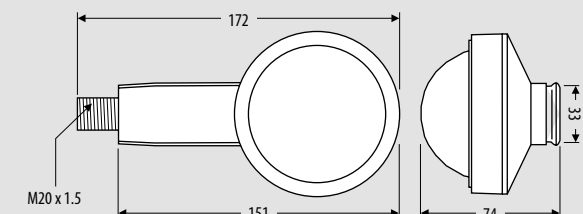

PIR presence/absence sensors

swivel



CP111000

PIR (passive infrared) sensors

Supplied with factory configuration for a simple and easy commissioning
The maximum contact current value (in A) indicated in the item description is valid for compact fluorescent lamps and LED lamps.
Connection 1 x 2.5 mm² or 2 x 1.5 mm²

- Designed for narrow and long range detection (corridors)
- The DALI 1-10 V versions have 2 independent channels:
1 dimmer channel and 1 on/off channel
- With 1 or 2 inputs for pushbutton control
- Possible use also as an absence detector with pushbutton switching on.
- Light intensity adjustment based on the natural light
- Minimum adjustable brightness level (for example in corridors)
- Programming via configuration Gateway (088240) and SmartBeam app.
- Control using the IR remote control (CP460007)
- Time settings: from 10 seconds to 99 minutes
- Programming via configuration Gateway (088240) and SmartBeam app.
- Control using the IR remote control (CP460007)

Item **PIR SENSORS, CEILING FLUSH MOUNTING, LONG RANGE FOR CORRIDORS, WITH SWIVEL HEAD**

EBDRC

PIR sensors with swivel head for corridors
Range up to 24 m
Recommended fixing height: 2.8 m
IP 40

CP111000	ON/OFF 10 A
CP111002	1-10 V 10 A analog dimmer
CP111001	10 A digital dimmer

Detection zone and dimensions

EBDRC



Detection zone

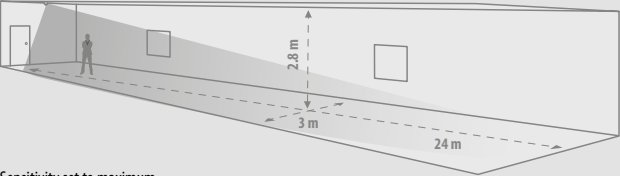

Sensitivity set to maximum
Detection head at 90°

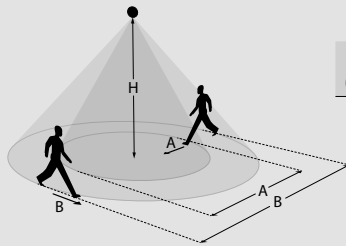

H (Height)	A (Diameter)	B (Diameter)
2.8 m	10 m	24 m

Dimensions (mm)

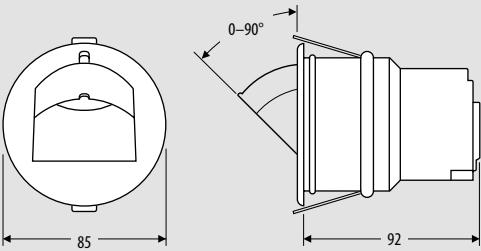



Microwave sensors

Supplied with factory configuration for a simple and easy commissioning
 The maximum contact current value (in A) indicated in the item description is valid for compact fluorescent lamps and LED lamps.
 Connection 1 x 2.5 mm² or 2 x 1.5 mm²

- The DALI 1-10 V versions have 2 independent channels: 1 dimmer channel and 1 on/off channel
- With 1 or 2 inputs for pushbutton control
- Possible use also as absence detector with pushbutton switching on
- Light intensity adjustment based on the natural light
- Minimum adjustable brightness level (for example in corridors)
- Programming via configuration Gateway (088240) and SmartBeam app
- Control using the IR remote control (CP460007)-
 Time settings: from 10 seconds to 99 minutes
- Ceiling surface/flush mounting or wall mounting using the specific accessories

MW also works through glass, plastic and plaster partitions.
 For this reason, the position of the sensor must be carefully selected, and its sensitivity adjusted.

Item	COMPACT MW SENSORS, WITH LOW PROFILE, CEILING FLUSH MOUNTING
	MWS6 Flat MW sensors Detection 360°, range ø 12-16 m Recommended fixing height: 2.8 m IP 40
CP360005	ON/OFF 10 A
CP360006	ON/OFF 6 A 2 outputs
CP360008	ON/OFF 10 A 12-24 V ac/dc
CP360012	ON/OFF 3 A 1 x NA/NC
CP360000	1-10 V 10 A analog dimmer
CP360001	DALI 10 A digital dimmer

	COMPACT MW SENSORS, CEILING SURFACE MOUNTING
	MWS6SM MW sensors for ceiling mounting Detection 360°, range ø 12 - 16 m (oval detection zone) Recommended fixing height: 2.8 m IP 40
CP360018	ON/OFF 10 A
CP360015	1-10 V 10 A analog dimmer
CP360016	DALI 10 A digital dimmer

Detection zone and dimensions

MWS6



Oval zone detection

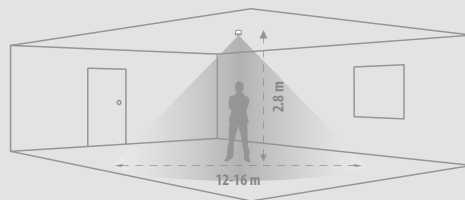

Dimensions (mm)

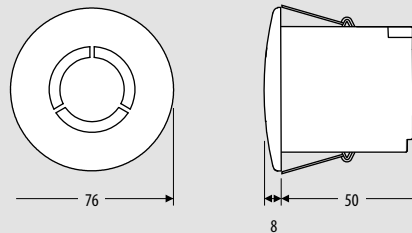

MWS6SM



Oval zone detection

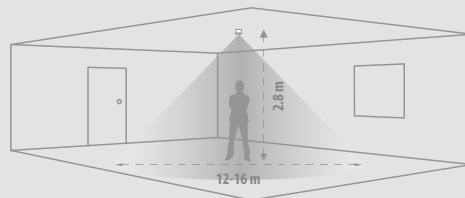

Dimensions (mm)

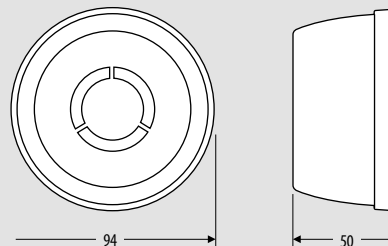

MW presence/absence sensors swivel



CP330037

Microwave sensors

Supplied with factory configuration for a simple and easy commissioning. The maximum contact current value (in A) indicated in the item description is valid for compact fluorescent lamps and LED lamps. Connection 1 x 2.5 mm² or 2 x 1.5 mm²

- Designed for narrow and long range detection (corridors)
- The DALI 1-10 V versions have 2 independent channels: 1 dimmer channel and 1 on/off channel
- With 1 or 2 inputs for pushbutton control
- Possible use also as absence detector with pushbutton switching on
- Light intensity adjustment based on the natural light
- Minimum adjustable brightness level (for example in corridors)
- Programming via configuration Gateway (088240) and SmartBeam app
- Control using the IR remote control (CP460007)
- Time settings: from 10 seconds to 99 minutes
- Ceiling surface/flush mounting or wall mounting using the specific accessories

MW also works through glass, plastic and plaster partitions. For this reason, the position of the sensor must be carefully selected, and its sensitivity adjusted.

Item

MW SENSORS, CEILING FLUSH MOUNTING, LONG RANGE FOR CORRIDORS, WITH SWIVEL HEAD

MWS3A

MW sensors for ceiling mounting, with swivel head, for example, for corridors with range up to 23 m
Recommended fixing height: 2.8 m
IP 40

CP330037	ON/OFF 10 A
CP330045	ON/OFF 3 A 1 x NA/NC
CP330002	1-10 V 10 A analog dimmer
CP330022	DALI 10 A digital dimmer

Detection zone and dimensions

MWS3A

Oval detection zone (90°)

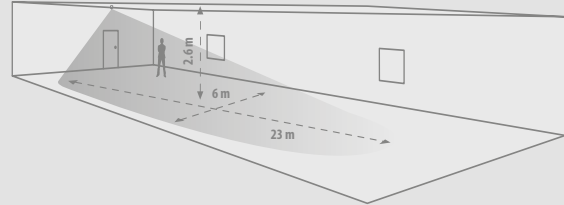

Oval detection zone (0°)

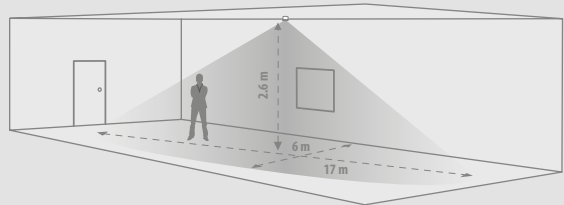

Dimensions (mm)

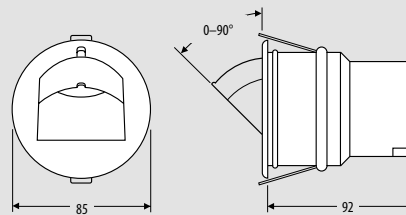

MW presence/absence sensors



CP340013

Microwave sensors

Supplied with factory configuration for a simple and easy commissioning. The maximum contact current value (in A) indicated in the item description is valid for compact fluorescent lamps and LED lamps. Connection 1 x 2.5 mm² or 2 x 1.5 mm²

- The DALI 1-10 V versions have 2 independent channels:
 - 1 dimmer channel and 1 on/off channel
- With 1 or 2 inputs* for pushbutton control
- Possible use also as absence detector with pushbutton switching on
- Light intensity adjustment based on the natural light
- Minimum adjustable brightness level (for example in corridors)
- Programming via configuration Gateway (088240) and SmartBeam app
- Control using the IR remote control (CP460007)
- Time settings: from 10 seconds to 99 minutes
- Flush mounting or luminaire mounting using accessories

MW also works through glass, plastic and plaster partitions. For this reason, the position of the sensor must be carefully selected, and its sensitivity adjusted.

Detection zone and dimensions

MWSS



Detection zone

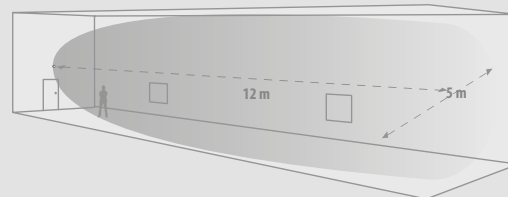
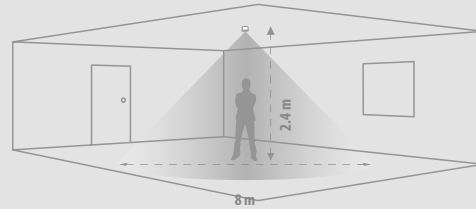

Dimensions (mm)

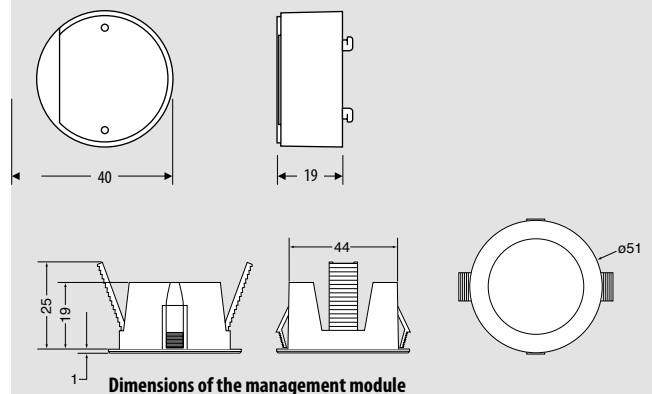

Dimensions of the management module

Item	COMPACT MW SENSORS, CEILING SURFACE/FLUSH MOUNTING
	MWSS Mini MW sensors with management module for ceiling mounting Detection 360°, range ø 8 m Recommended fixing height: 2.4 m IP 40
CP340013	ON/OFF 3 A
CP340002	1-10 V 3 A analog dimmer
CP340007	DALI 3 A digital dimmer

MW presence/absence sensors



Microwave sensors

Supplied with factory configuration for a simple and easy commissioning
The maximum contact current value (in A) indicated in the item description is valid for compact fluorescent lamps and LED lamps.
Connection 1 x 2.5 mm² or 2 x 1.5 mm²

- Presence detection with output switching
- Surface mounted version (MWS1A-C) with a maximum detection range diameter of 10 m at a height of 2.8 m
- Programming via configuration Gateway (088240) and SmartBeam app
- Control using the IR remote control (CP460007)
- Also suitable for heating and ventilation applications
- Time settings: from 10 seconds to 99 minutes

MW also works through glass, plastic and plaster partitions. For this reason, the position of the sensor must be carefully selected, and its sensitivity adjusted.

Item	SQUARE MW SENSORS, CEILING SEMI-PROTRUDING MOUNTING (CEILING LIGHTS)
	MWS1A-C MW Sensors Semi-protruding mounting Detection 360°, range ø 10 m Recommended fixing height: 2.8 m To be used with flush-mounting box (min. depth 25 mm) IP 40
CP320009	ON/OFF 6 A
CP320011	ON/OFF 3 A 1 x NA/NC
	MWS1A-C-IP MW presence sensors Surface mounting Detection 360°, range ø 10 m Recommended fixing height: 2.8 m IP 66
CP320003	ON/OFF 6 A
CP320006	ON/OFF 3 A 1 x NA/NC

Item	SQUARE MW SENSORS, LONG RANGE, WALL SEMI-PROTRUDING MOUNTING
	MWS1A MW Sensors Semi-protruding mounting Range 25 m, width 6 m Recommended fixing height: 2.8 m To be used with flush-mounting box (min. depth 25 mm) IP 40
CP320025	ON/OFF 6 A
CP320023	ON/OFF 6 A 12-24 V AC/DC 1 x NO/NC
CP320029	ON/OFF 3 A 1 x NA/NC
	MWS1A-IP MW presence sensors Surface mounting Range 25 m, width 6 m Recommended fixing height: 2.8 m IP 66
CP320015	ON/OFF 6 A
CP320014	ON/OFF 6 A 12-24 V AC/DC 1 x NO/NC
CP320019	ON/OFF 3 A 1 x NA/NC

Detection zone and dimensions

MWS1A / MWS1A-C



MWS1A : wall mounting version



MWS1A-C : ceiling light version

Detection zone

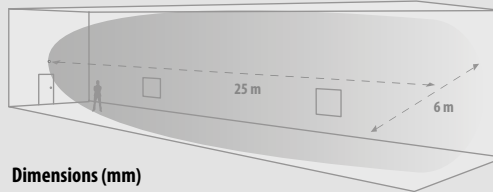
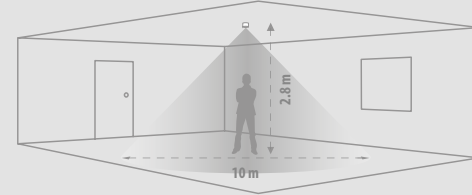

Dimensions (mm)

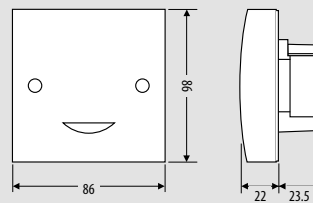

MWS1A-IP / MWS1A-C-IP



MWS1A-IP : wall mounting version



MWS1A-C-IP : ceiling light version

Detection zone

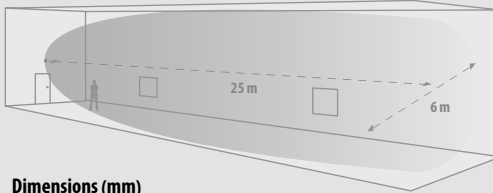
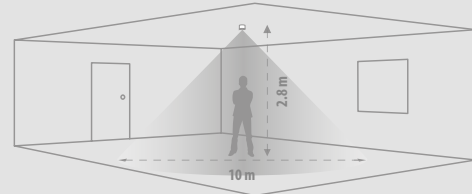

Dimensions (mm)

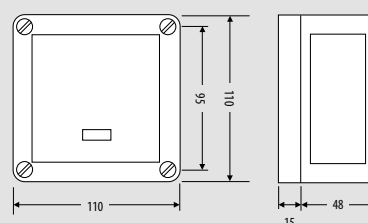

Presence/absence sensors

CASAMBI technology



CP130068



CP100055



CP100053

Item	CEILING FLUSH MOUNTING
CP130068	Flat PIR (passive infrared) sensor in CASAMBI technology, ceiling flush mounting - standard height. DALI - IP 40 digital dimmer Detection 360°, range ø 7 m with recommended fixing height: 2.8 m.
CP100055	Flat PIR (passive infrared) sensor in CASAMBI technology, ceiling flush mounting - standard height. DALI - IP 40 digital dimmer Detection 360°, range ø 15 m with recommended fixing height: 2.8 m.

FOR HIGH CEILINGS

CP100053	Flat PIR (passive infrared) sensor in CASAMBI technology, ceiling flush mounting for high heights DALI - IP 40 digital dimmer Flat PIR sensors for high ceilings Detection 360°, range ø 40 m with recommended fixing height: 15 m Adjustable detection zone (masking supplied)
----------	---

KNX technology



CP130032



CP130071



CP360003



CP100018

Item	CEILING FLUSH MOUNTING
CP130032	Flat PIR (passive infrared) sensor in KNX technology, ceiling flush mounting for standard heights. IP 42
CP130071	Mid range Compact PIR sensors for ceiling applications.
CP360003	Flat MW (microwave) sensor in KNX technology, ceiling flush mounting, IP 40 Compact PIR sensor for ceiling applications.
CP330027	Flat MW (microwave) sensor in KNX technology, ceiling flush mounting. Adjustable head for special applications IP 40 Compact PIR sensor for ceiling applications.

FOR HIGH CEILINGS

CP100018	Flat PIR (passive infrared) sensor in KNX technology, ceiling flush mounting for high heights High sensitivity sensor - IP 65 For high ceiling applications.
----------	--

Casambi technology

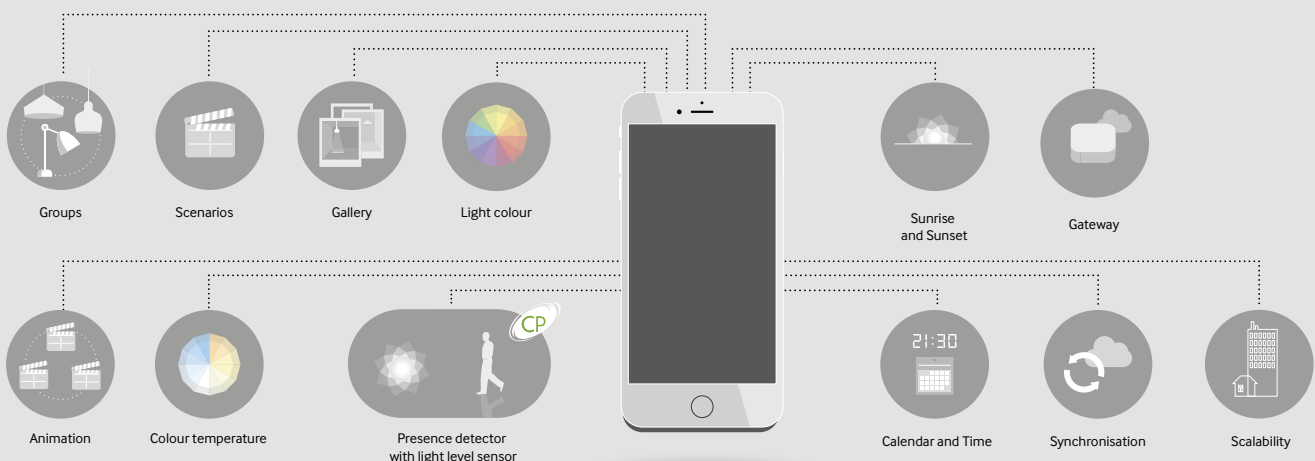



CP090000



CP070001



CP330018



CP090004



CP330017



CP330019



CP100011



CP230000



CP130037

Item	INSTALLATION ACCESSORIES
CP090000	surface mounting box for the sensors of EBDSPIR, EBDHS, EBDMR, MWS6 range
CP070001	surface mounting box extension, for the sensors of EBDSPIR, EBDHS, EBDMR, MWS6 range
CP330018	surface mounting rear box extension for the MWS3A range
CP330017	surface mounting box for EBDRC and MWS3A range sensors
CP090004	IP65 rated outdoor housing for detectors of the EBDSPIR, EBDHS, EBDMR, MWS6 range
CP330019	wall mounting bracket for EBDRC and MWS3A range sensors
CP100011	wall mounting bracket for EBDHS range sensors
CP230000	Accessory suitable for all ceiling flush mounting detectors It offers more wiring space for installations with multiple connections. EBDSPIR, EBDHS, EBDMR, MWS6 range sensors
CP130037	adhesive shielding masks for the EBDSPIR sensor range (pack of 10)

Use of shielding masks for sensors.



Configuration gateway and remote control



0 882 40



CP460007

Item

CONFIGURATION GATEWAY

0 882 40



The gateway allows the programming and adjustment of the operating parameters of the various sensors: advanced lighting control. It allows to adjust the time settings, the brightness threshold and the detection sensitivity. It is possible to store, share, and prepare all product settings before going on site, and also to duplicate the parameters of a device to replicate them on another one. Using the NFC and IR communication protocols, with this configuration gateway the products can be configured before, during and after installation.

Some of the available functions are:

- Product configuration in IR and NFC mode
- Quick access to the product technical documentation
- Saving and sharing the configuration parameters
- Copy-paste of a configuration from one product to another
- Diagnostic support
- Adaptation of the brightness measurement of the detectors to their respective environments
- The smartphone must be connected to the gateway via the 'BLUETOOTH' protocol, while the gateway communicates with the sensors using IR (infrared) technology.

The gateway works with the "SmartBeam" app, available on the Android (Playstore) and iOS (Apple Store) platforms.

Item

SYSTEM MANAGEMENT REMOTE CONTROL FOR THE END USER

CP460007

Infrared (IR) compact remote control, IR range up to 7 m. It allows the activation of scenarios: on, off and dimming of loads.

The remote control can be used by the end customers to operate the various sensors installed. The remote control must be pointed at the sensor to be controlled.

Compatible with stand alone sensors only.

Supplied with CR2025 batteries

Item

HANDSET

CP460004

Remote control for configuration of:

- Function test
- "Burn-in" time
- Reset
- Presence or absence detection
- Delay time
- Motion sensitivity
- Manual operation
- Lighting levels "target value", "above" and "below"

CP460009

Remote control for advanced programming for all CP sensors.

With screen and USB port, bidirectional communication, macros for recording and duplication of the configuration, setting of the parameters of the advanced features

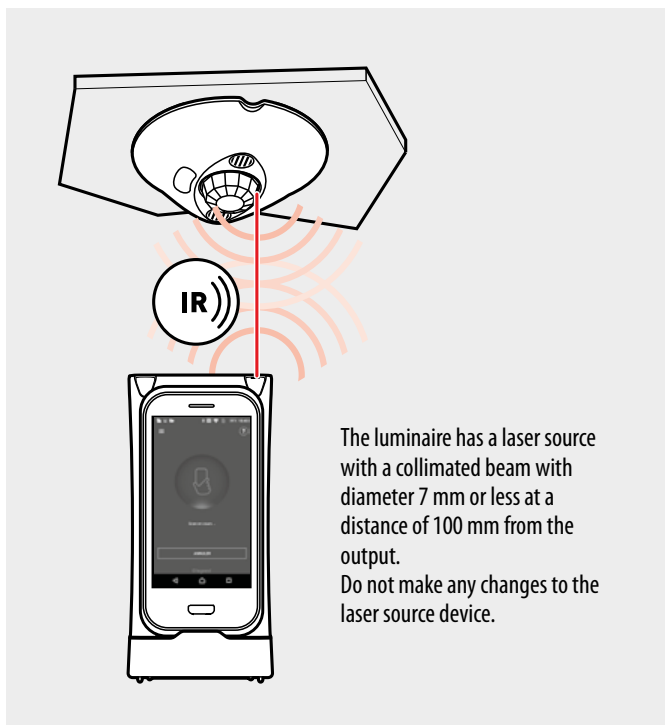

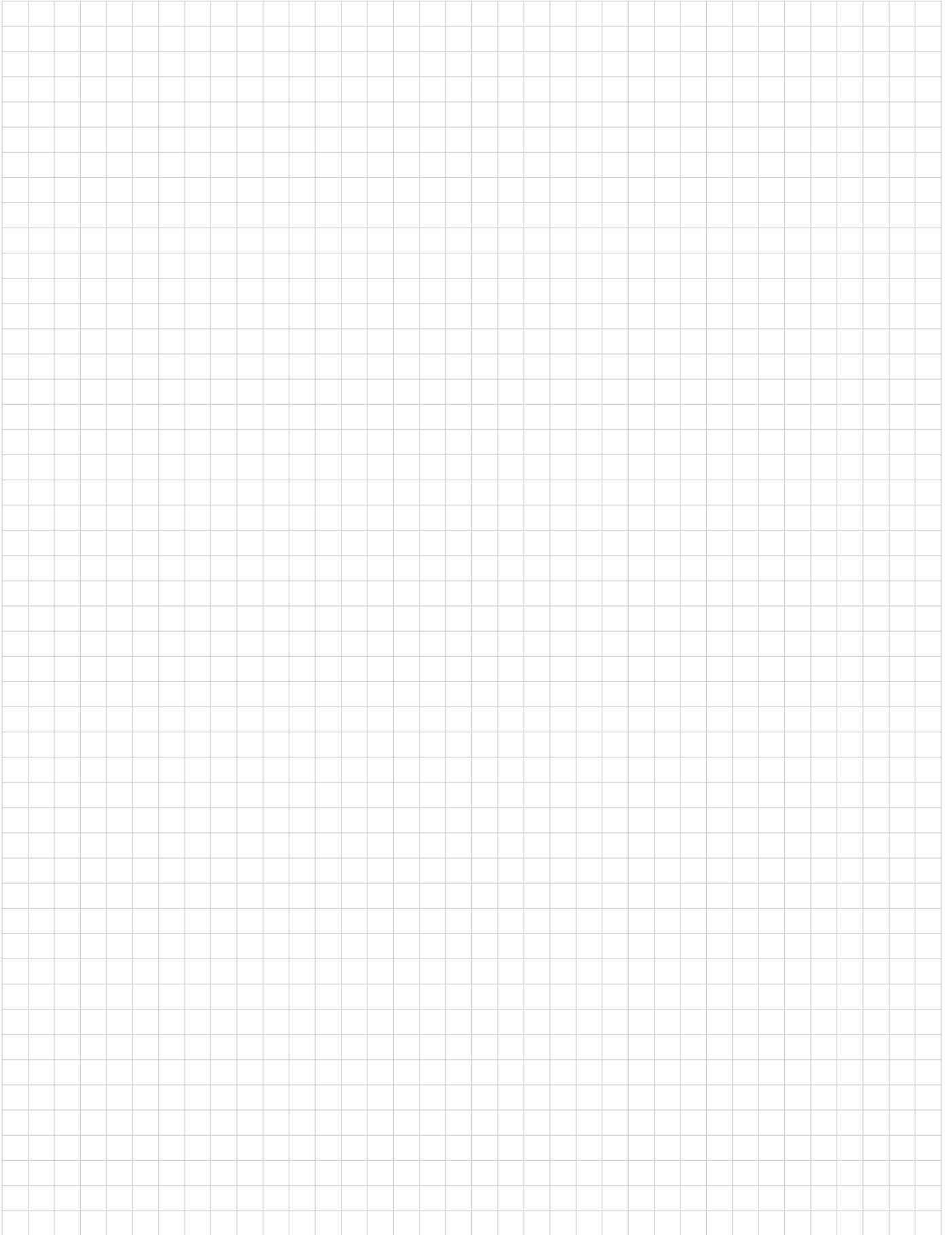

NOTES

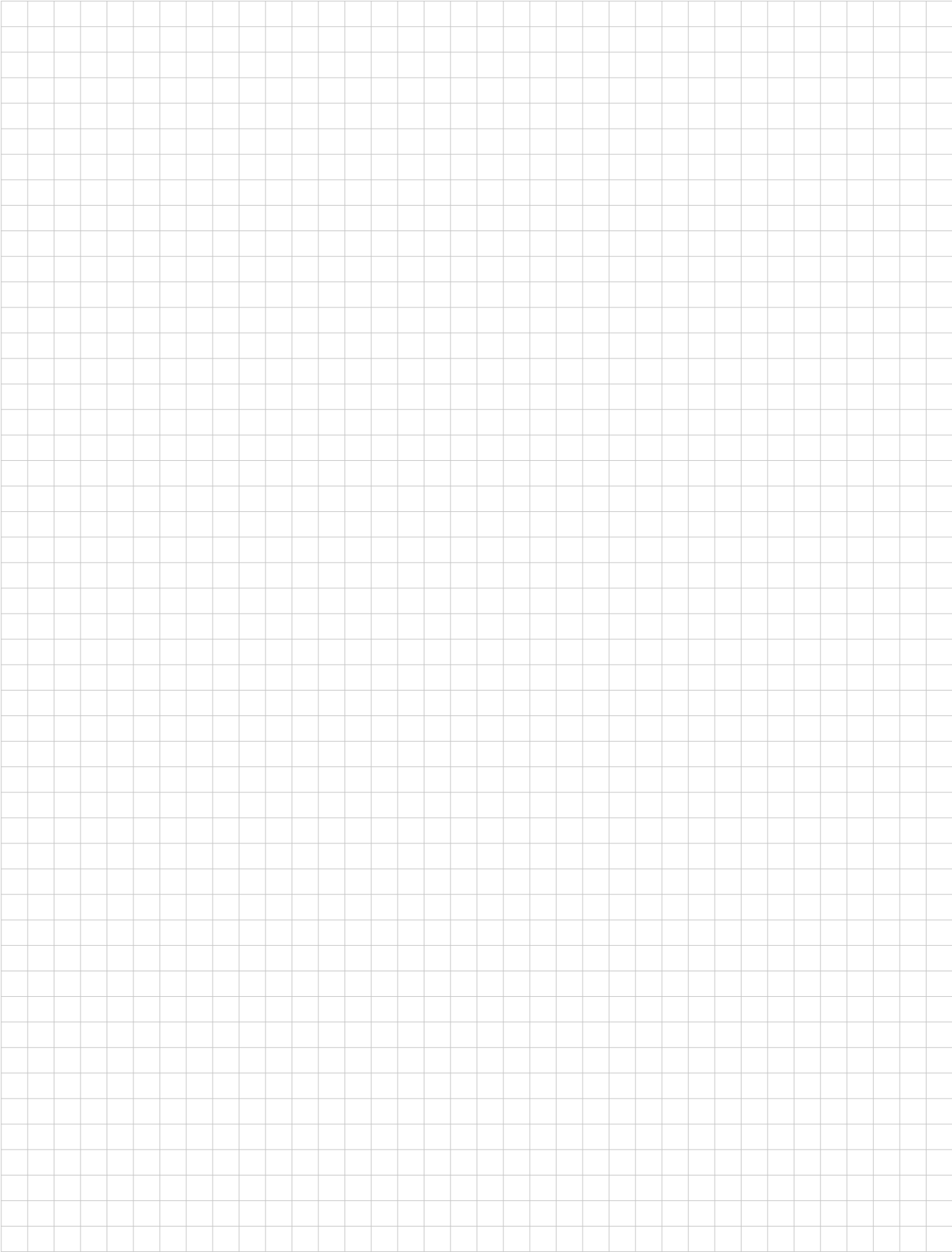

CP Electronics

A brand of  legrand

Leaders Controlling the Light



Lighting & energy controls



Legrand Ltd., Bulgaria
Business Park Sofia, Mladost IV
Building 7A, Office P06
1766 Sofia - Bulgaria
Tel. +359 2 489 9297

Energy Efficiency in Buildings

These products form a wide range of devices to enable Energy Efficiency in Buildings – A structured and holistic approach to reducing the carbon footprint and increasing sustainability of businesses.



www.facebook.com/Legrand Bulgaria



[legrand_bulgaria](https://www.instagram.com/legrand_bulgaria)



[ww.youtube.com/user/legrand](https://www.youtube.com/user/legrand)



www.linkedin.com/company/legrand-bulgaria/



www.legrand.bg