

# Cat. 6 RJ 45 110 Keystone

Cat. No(s): 6 327 05/06

## CONTENTS Page

1. General characteristics . . . . .	1
2. Presentation . . . . .	1
3. Technical characteristics . . . . .	1
4. Overall dimensions . . . . .	2
5. Usual connection of RJ45 sockets . . . . .	2
6. Standards and approvals . . . . .	3
7. Performance . . . . .	3

### 1. GENERAL CHARACTERISTICS

Category 6 RJ45 socket.  
Enables high speed data transmission (Gigabit Ethernet).

### 2. PRESENTATION

Référence	Désignation	UTP	FTP	Weight (g)
6 327 05	Keystone RJ45 UTP socket cat.6	G51		5,88
6 327 06	Keystone RJ45 STP socket cat.6		G53	12,68

6 327 05

#### RJ45 Cat 6 UTP 110 Keystone

A	green	C	orange
B	blue	D	brown

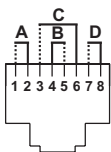

EIA 568 A

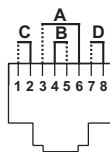

EIA 568 B

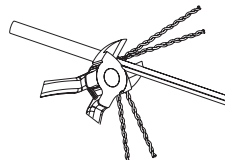
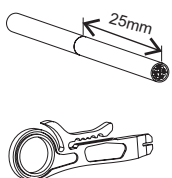

6 327 06

#### RJ45 Cat 6 FTP 110 Keystone

A	green	C	orange
B	blue	D	brown

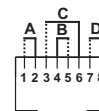

EIA 568 A

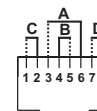

EIA 568 B

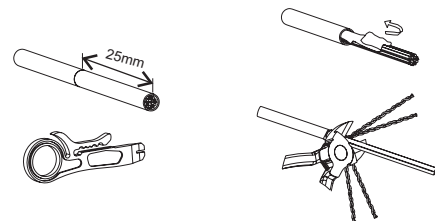

### 3. TECHNICAL CHARACTERISTICS

#### 3.1 Material characteristics

Contacts: gold/nickel, minimum thickness of gold > 1,2 μm  
Metal parts: bronze  
Polycarbonate

#### 3.2 Electrical characteristics

Breakdown voltage ≥ 1000 V  
Contact resistance ≤ 20 mΩ  
Insulation resistance ≥ 500 MΩ at 100 V DC

#### 3.3 Mechanical characteristics

Max. number of connections and disconnections: 5 without refreshing the wiring.  
Endurance: 750 movements (plug insertion/withdrawal)

#### 3.4 Climatic characteristics

Operating temperature: - 40° C to + 70° C  
Humid heat cycle 21 days

## 4. OVERALL DIMENSIONS

6 327 05

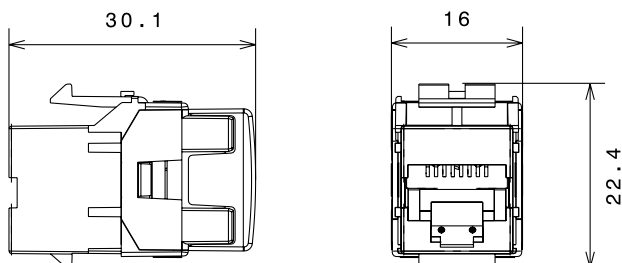

6 327 06

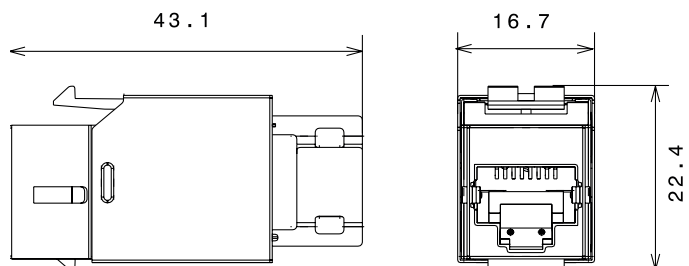

## 5. USUAL CONNECTION OF RJ 45

6 327 06

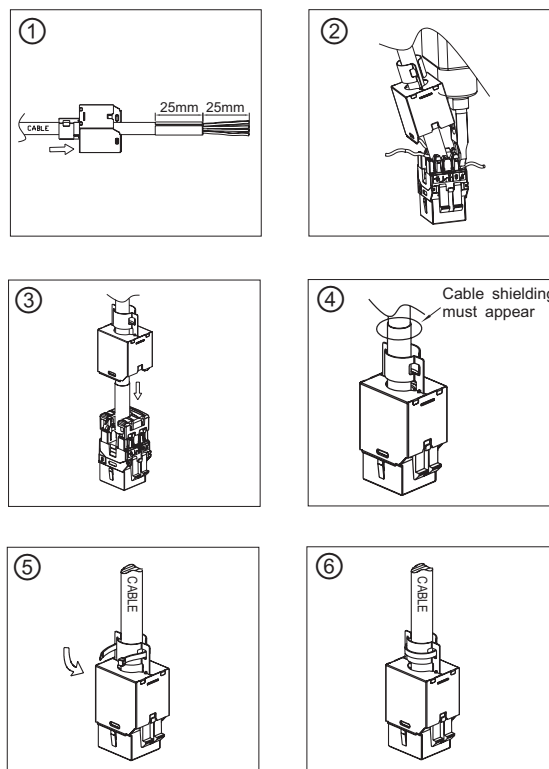

## 5. USUAL CONNECTION OF RJ 45

6 327 05

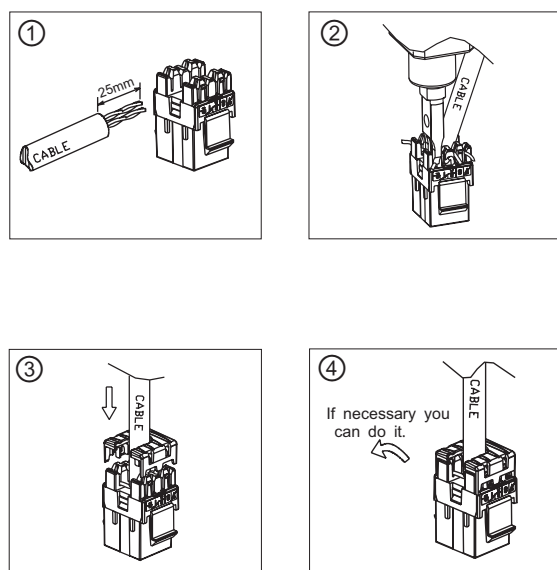

Accepts the following cable connectors:  
 RJ11 (4 contacts), RJ12 (6 contacts), RJ45 (8 contacts).  
 Double colour code EIA – TIA 568 A and B on terminals:  
 - STP 9 contacts 360° screen

Conductors supported:  
 - AWG 22 to 26  
 - Multiple-wire: AWG 26  
 - Polyethylene conductor insulation

RJ 45 connectors are equipped with a locking nut that does not require the use of a specific tool and which enables re-cabling in the event of error.

This system allows the wire pairs to be spread easily before mounting them on the connector.

Spreading cables ensures that each pair is separated by the specified 13 mm.

**6. STANDARDS AND APPROVALS**

Conforms to standards: ISO 11801 Edition 2  
 CENELEC EN 50173-1 2007  
 EIA/TIA 568-C2  
 ISO/IEC series 60603-7

**7. PERFORMANCE**

**Component performance (RJ 45 connectors)**

Return loss

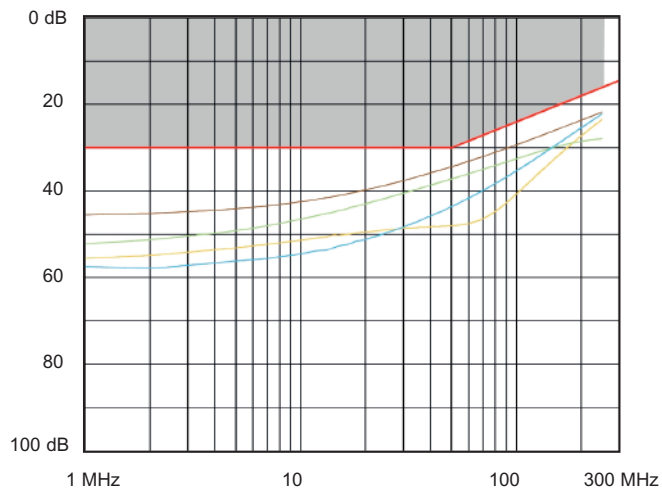

Attenuation

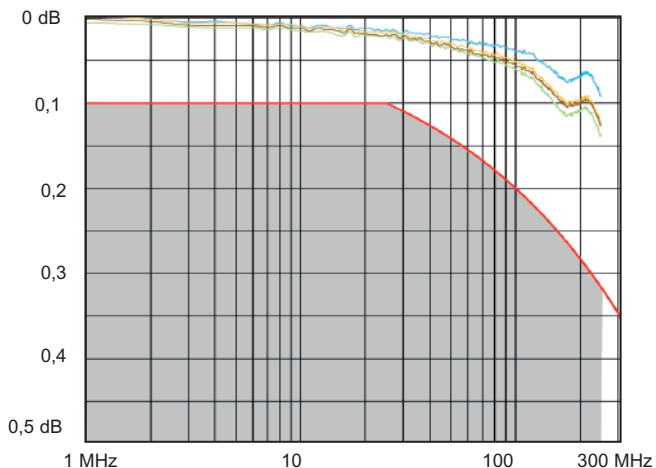

**7. PERFORMANCE (cont.)**

**Component performance (RJ 45 connectors)**

FEXT (Far end Crosstalk Attenuation)

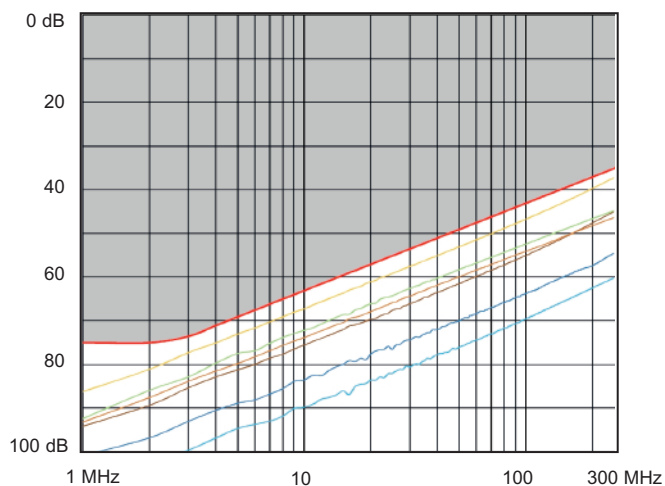

NEXT (Near end Crosstalk Attenuation)

