



**Customer Care Center**



Reach out to our Customer Care team in your location:

**Go2SE**



Schneider Charge

Please scan the QR code of Go2SE on product nameplate to get the latest edition of user manual and watch the installation videos.

<b>Safety</b> .....	<b>3</b>
<b>1 Contents</b> .....	<b>4</b>
<b>2 Description</b> .....	<b>5</b>
2.1 Product References and Characteristics .....	5
2.2 Product Description .....	5
<b>3 Characteristics</b> .....	<b>7</b>
3.1 General Data .....	7
3.2 Certification.....	7
3.3 Environment.....	7
3.4 Accessories.....	7
<b>4 Protection</b> .....	<b>8</b>
Upstream Protections .....	8
Distribution System Operator (DSO) .....	8
Power Cable Requirements.....	8
<b>5 Electrical Diagram</b> .....	<b>9</b>
<b>6 Installation</b> .....	<b>10</b>
6.1 Equipment Supplied by User .....	10
6.2 Tools Supplied by User .....	10
6.3 Wall Mounting .....	10
6.4 Wiring.....	12
<b>7 Connection</b> .....	<b>17</b>
7.1 Wire-up Signal Line .....	17
7.2 Wire-up Power Supply .....	17
<b>8 Inspection</b> .....	<b>17</b>
<b>9 Commissioning with Application</b> .....	<b>18</b>
9.1 Commissioning with eSetup Application .....	18
9.1.1 Connect & Update .....	18
9.1.2 Configure Electrical Settings .....	19
9.1.3 Pre-configure the Smart Charging Application (Optional) .....	19
9.1.4 Finalize .....	19
9.1.5 Ready to Operate .....	19
9.2 Commissioning with Wiser Home Application.....	20
9.2.1 Connect & Update .....	20
9.2.2 Configure Electrical Settings .....	21
9.2.3 Configure Network Settings (Optional).....	21
9.2.4 Finalize .....	21
9.2.5 Ready to Operate .....	21
<b>10 Operation</b> .....	<b>22</b>
10.1 Connecting the Electric Vehicle Charging Station .....	22
10.2 Disconnecting the Electric Vehicle.....	22
10.3 Connection to a Smart Charging Application.....	22
10.3.1 Prerequisites .....	22
10.3.2 Connect.....	23
10.3.3 Ready to Operate Remotely.....	23
<b>11 Cable Storage</b> .....	<b>24</b>
<b>12 Charging Station Indicators</b> .....	<b>24</b>
<b>13 Basic Troubleshooting</b> .....	<b>25</b>
<b>14 Wireless Feature Declaration</b> .....	<b>25</b>
<b>15 Recycle</b> .....	<b>25</b>

The information provided in this document contains general descriptions, technical characteristics and/or recommendations related to products/solutions.

This document is not intended as a substitute for a detailed study or operational and site-specific development or schematic plan. It is not to be used for determining suitability or reliability of the products/solutions for specific user applications. It is the duty of any such user to perform or have any professional expert of its choice (integrator, specifier or the like) perform the appropriate and comprehensive risk analysis, evaluation and testing of the products/solutions with respect to the relevant specific application or use thereof.

The Schneider Electric brand and any trademarks of Schneider Electric SE and its subsidiaries referred to in this document are the property of Schneider Electric SE or its subsidiaries. All other brands may be trademarks of their respective owner.

This document and its content are protected under applicable copy right laws and provided for informative use only. No part of this document may be reproduced or transmitted in any form or by any means (electronic, mechanical, photocopying, recording, or otherwise), for any purpose, without the prior written permission of Schneider Electric.

Schneider Electric does not grant any right or license for commercial use of the document or its content, except for a non-exclusive and personal license to consult it on an "as is" basis.

Schneider Electric reserves the right to make changes or updates with respect to or in the content of this document or the format thereof, at any time without notice.

Electrical equipment should be installed, operated, serviced, and maintained only by qualified personnel. No responsibility is assumed by Schneider Electric for any consequences arising out of the use of this material.

## Safety

### Important Information



Read these instructions carefully, and look at the equipment to become familiar with the device before trying to install, operate, or maintain it. The following special messages may appear throughout this documentation or on the equipment to warn of potential hazards or to call attention to information that clarifies or simplifies a procedure.



The addition of this symbol to a "Danger" or "Warning" safety label indicates that an electrical hazard exists which will result in personal injury if the instructions are not followed.



This is the safety alert symbol. It is used to alert you to potential personal injury hazards. Obey all safety messages that follow this symbol to avoid possible injury or death.

#### **⚠ DANGER**

**DANGER** indicates a hazardous situation which, if not avoided, **will result** in death or serious injury.

#### **⚠ WARNING**

**WARNING** indicates a hazardous situation which, if not avoided, **could result** in death or serious injury.

#### **⚠ CAUTION**



**CAUTION** indicates a hazardous situation which, if not avoided, **could result** in minor or moderate injury.

#### **NOTICE**

**NOTICE** is used to address practices not related to physical injury.





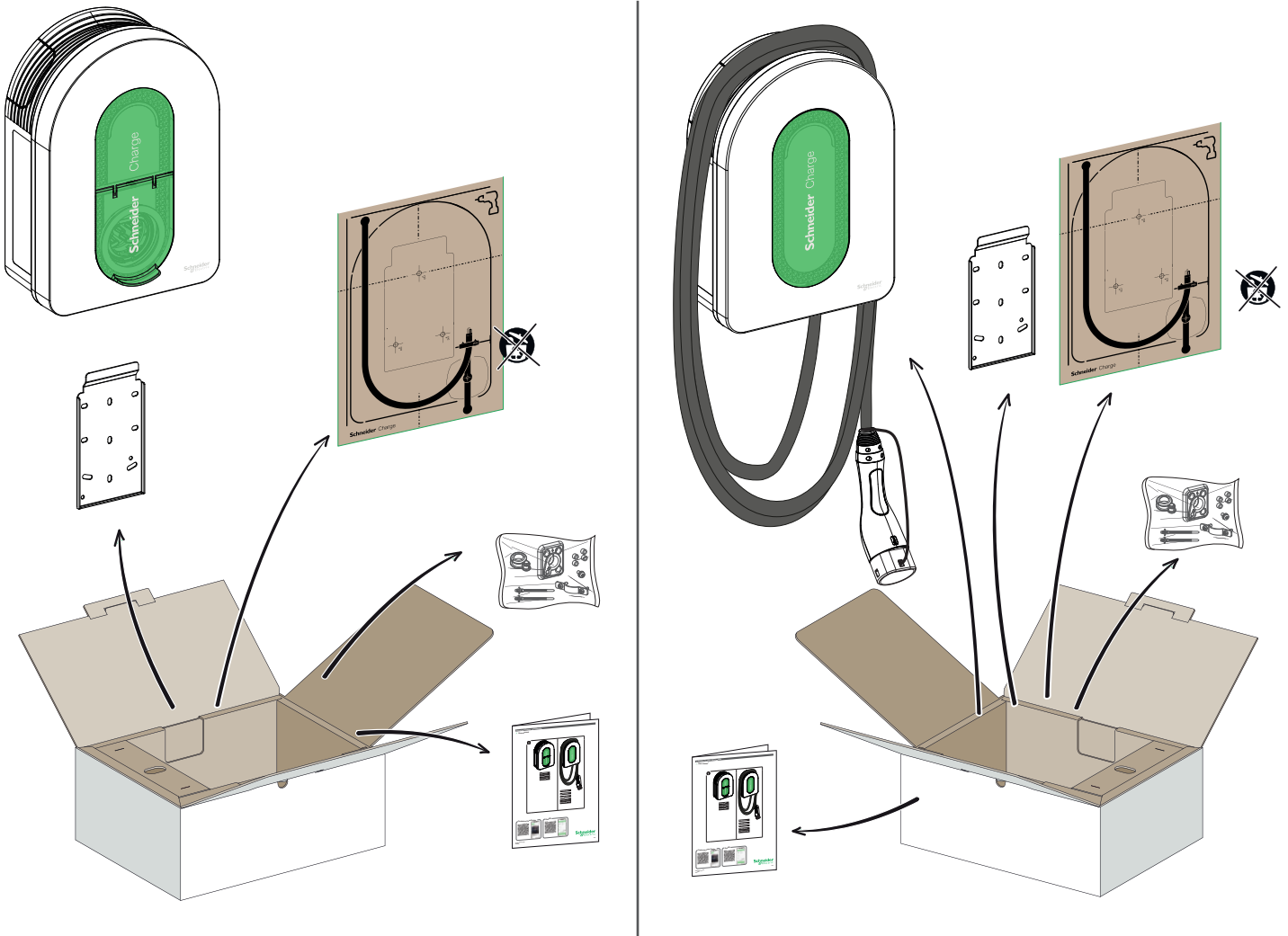

#### **PLEASE NOTE**

- The installation, maintenance and eventual replacement of this device must only be carried out by a qualified electrician.
- This device must not be repaired.
- All applicable local, regional and national regulations must be complied with during the installation, use, maintenance and replacement of this device.
- This device should not be installed if, when unpacking it, you observe that it is damaged.
- Schneider Electric cannot be held responsible in the event of non-compliance with the instructions in this document and in the documents to which it refers.
- The service instruction must be observed throughout the life time of this device.

Symbol	Content
	<ul style="list-style-type: none"> <li>■ <b>Electrical hazard</b> <ul style="list-style-type: none"> <li>□ The equipment must be installed, commissioned, serviced, and maintained only by qualified personnel.</li> <li>□ The installation should comply with existing standards and local regulations.</li> <li>□ See section "Installation" page 10 for details.</li> </ul> </li> <li>■ <b>Electrical hazard / fire hazard</b> <ul style="list-style-type: none"> <li>□ The charging station, the cable and the connector must be regularly checked by to detect any potential damage (visual inspection).</li> <li>□ In case the charging station is damaged, it must be immediately turned off and replaced.</li> <li>□ Do not perform any maintenance work on the equipment.</li> <li>□ Do not open or modify the charging station.</li> <li>□ Do not remove signs such as safety symbols, warnings, nameplates, signs or markings.</li> </ul> </li> <li>■ Do not use any extension cable to connect the charging station to the electric vehicle.</li> <li>■ Do not connect any other type of loads to the charging station (power tools, etc.). Only connect electric vehicles or their charging equipment.</li> <li>■ Do not disconnect the connector by pulling the cable. Hold the connector in your hand to disconnect the connector from the electrical vehicle.</li> <li>■ Do not bend, squeeze or tilt the connector so that it is mechanically damaged.</li> <li>■ Prevent the connector to be in contact with heat source, dirt or water.</li> <li>■ When using an integrated charging station to charge your electric car, please read the vehicle's tips and instructions carefully.</li> </ul> <p><b>Failure to follow safety instructions can result in death, injury, and equipment damage.</b></p>
	<ul style="list-style-type: none"> <li>■ Never clean the charging point by spraying it with water (Hose for garden watering, high pressure cleaners, etc)</li> </ul>

# 1 Contents



	Gasket body		Gasket-small <sup>(3)</sup>
	Ziptec x 2		Gasket-big <sup>(4)</sup>
	Spacer x 4 <sup>(1)</sup>		Clamp-big <sup>(4)</sup>
	Torx M4 * 10 <sup>(2)</sup>		

(1) Only used for installation on irregular wall

(2) Replacement screw

(3) Used for power cable 10-20 mm

(4) Used for power cable 20-23 mm, only provided in EVH5A22N2S

# 2 Description

## 2.1 Product References and Characteristics

Product Reference		EVH5A07 N2C5	EVH5A07 N2C7	EVH5A11 N2C5	EVH5A11 N2C7	EVH5A22 N2S
Market	IEC	■	■	■	■	■
	France					
Electrical Characteristics	Network	1P+N	1P+N	1P/3P+N	1P/3P+N	1P/3P+N
	Power rating (1P/3P) (kW)	7.4	7.4	(3.7)*/11	(3.7)*/11	(7.4)*/(11)**/22
	Max Current per phase (A)	32	32	16	16	32
	Number of charge point	1	1	1	1	1
	T2S socket	-	-	-	-	■
Attached cable		5 m/16 ft	7 m/22 ft	5 m/16 ft	7 m/22 ft	-
Protections	In-built RDC-DD 6mA	■	■	■	■	■
	IP55	■	■	■	■	■
	IK10	■	■	■	■	■
Load Management	With Anti-Tripping Module EVA2HPC1 (1P+N until 100A)	■	■			■
	With Anti-Tripping Module EVA4HPC1 (1P+N until 50A)	■	■			■
	With Anti-Tripping Module EVA2HPC3 (3P+N until 50A)			■	■	■
	DSO input (dry contact)	■	■	■	■	■
Installation	Wall mounted					
	Dimensions	352x244x107 mm 13.9x9.6x4.2 in		352x244x107 mm 13.9x9.6x4.2 in		352x244x117 mm 13.9x9.6x4.6 in
	Weight	4.5 kg/9.92 lb	5.3 kg/11.68 lb	4.5 kg/9.92 lb	5.2 kg/11.46 lb	3.2 kg/7.05 lb
Configuration	With commissioning application (Wiser Home or eSetup) (Wi-Fi Access Point)	■	■	■	■	■
Connectivity for Supervision	Wi-Fi 2.4 GHz	■	■	■	■	■
	Ethernet (1 port)	■	■	■	■	■
	OCPP1.6J	■	■	■	■	■
	Wiser Home	■	■	■	■	■
	Connect-able to third party app	■	■	■	■	■
In-built Metering	Power	■	■	■	■	■
	Current	■	■	■	■	■
	Energy	■	■	■	■	■

\* When power supply is single-phase, please use charger according to the power in brackets.

\*\* With derating by commissioning application (Wiser Home or eSetup).

## 2.2 Product Description

- This charging station is an electrical appliance that supplies electric energy to charge plug-in electric vehicles for indoor and private outdoor areas.
- When installing and using the charging station, ensure that you comply with local regulations.
- The intended use of the equipment includes, in all cases, the environmental conditions established for the equipment.

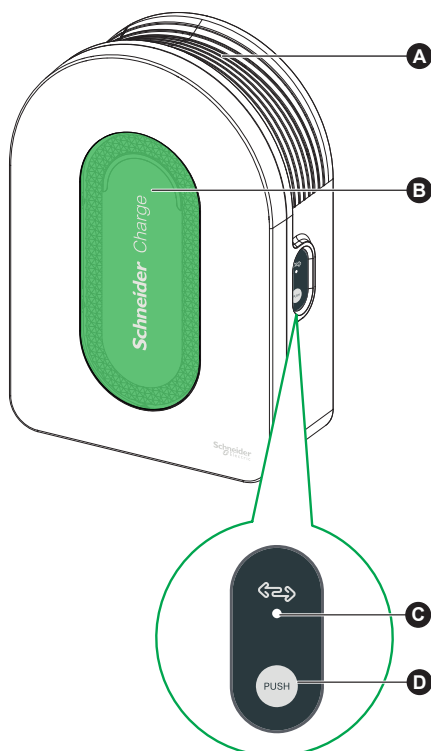

<b>A</b>	Cable winding trough	When not in use, wrap the charging cable around the charging station's trough to avoid tripping hazards and equipment damage.
<b>B</b>	Front indicator light	Indicates the status of the charging station and charging session, Section "Charging Station Indicators", page 24.
<b>C</b>	Side indicator light	Indicates status during Wi-Fi access point commissioning and anti-tripping module pairing.
<b>D</b>	Functional button	Press to enable Wi-Fi access point/Reset PIN Code/anti-tripping module pairing (power off and then back on the product to enable this button).

# 2 Description

## 2.2 Product Description

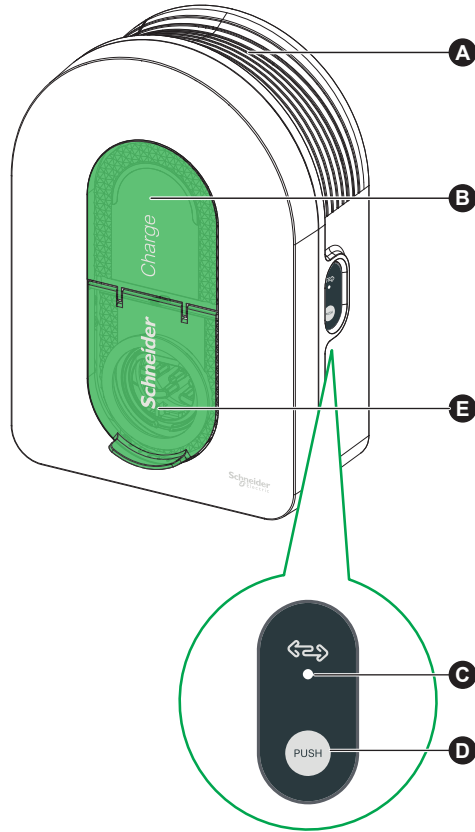

<b>A</b>	Cable winding trough	When not in use, wrap the charging cable around the charging station's trough to avoid tripping hazards and equipment damage.
<b>B</b>	Front indicator light	Indicates the status of the charging station and charging session, Section "Charging Station Indicators", page 24.
<b>C</b>	Side indicator light	Indicates status during Wi-Fi access point commissioning and anti-tripping module pairing.
<b>D</b>	Functional button	Press to enable Wi-Fi access point/Reset PIN Code/anti-tripping module pairing (power off and then back on the product to enable this button).
<b>E</b>	Charging socket	Plug in your T2 charging cable.

# 3 Characteristics

## 3.1 General Data

- Ingress protection rating: IP55 (IEC 60529)
- Impact protection rating: IK10 (IEC 62262)
- Socket for T2 cable or T2 attached cable according to IEC 62196-1 and IEC 62196-2
- Operating temperature:
  - -30°C to +50°C for 7.4 kW (1P 32A) Schneider Charge with T2S socket (-22°F to +122°F) (up to 55°C/131°F with derating)
  - -30°C to +55°C for 11 kW (3P 16A) Schneider Charge with T2S socket (-22°F to +131°F)
  - -30°C to +45°C for 22 kW (3P 32A) Schneider Charge with T2S socket (-22°F to +113°F) (up to 55°C/131°F with derating)
  - -35°C to +50°C for 7.4 kW (1P 32A) Schneider Charge with attached cable (-31°F to +122°F) (up to 55°C/131°F with derating)
  - -35°C to +55°C for 11 kW (3P 16A) Schneider Charge with attached cable (-31°F to +131°F)
- Storage temperature: -40°C to +85°C (-40°F to +185°F)
- Relative humidity: 5-95 %
- Rated voltage (depending on model):
  - For 7.4 kW: 220-240V AC +/- 10 %, 50/60 Hz
  - For 11 kW/22 kW: 380-415V AC +/- 10 %, 50/60 Hz
- Rated charging current: 32A for 7.4 kW, 16A for 11 kW and 32A for 22 kW
- Accuracy of current, voltage and power measurement: 1 %
- Diagram of the earthing system: TN-S, TN-C-S, TT, IT (only 220-240V, single-phase)
- Designed for indoor and outdoor use
- OCPP 1.6J
- Wi-Fi feature 2.4 GHz
  - Operating frequency bands: 2412 MHz-2472 MHz
  - Maximal RF output power: less than 20 dBm (18.25 dBm)
- 1 Ethernet port

## 3.2 Certification

- IEC/EN 61851-1
- IEC 61851-21 - 2
- EN 61000-6-1
- EN 61000-6-3
- EN 300328

## 3.3 Environment

- Compliant with the RoHS European directive
- Compliant with the REACH European regulation

## 3.4 Accessories

- Schneider charge anti-tripping module (peak controller), single-phase, low rating (EVA4HPC1, 16-50A)
- Schneider charge anti-tripping module (peak controller), single-phase, high rating (EVA2HPC1, 32-100A)
- Schneider charge anti-tripping module (peak controller), three-phase, low rating (EVA2HPC3, 16-50A)
- Schneider charge Gun Holder (EVA5GH) (For Charging Station with attached cable)

### Notes:

- The anti-tripping module adapt/limits the power draw of the Schneider Charge, **in some cases completely stopping the charging**, to avoid a power outage of your home electrical supply. Schneider Charge provides pairing function with anti-tripping module. Refer to the anti-tripping module's instruction sheet.
- **according to the power available for the electrical installation, especially if the home is equipped with a heat pump. Minimum recommendation: 25A 3P+N.**

# 4 Protection

## Upstream Protections

- The Electric Vehicle measures the ground resistance and will only start charging if it is lower than the threshold defined by the Electric Vehicle manufacturer. Refer to the vehicle's technical documentation.
  - The choice of electrical protections and wire gauges must comply with local regulations and the information below as well as the constraints of the electrical installation. In particular, the selected protection must not only satisfy the requirements of IEC 61851-1 ed 3.0 (1) but must also limit the value of  $I^2t$  to less than 75 000 A<sup>2</sup>s in case of a short-circuit.
- (1) According to section 13 of IEC 61851-1 ed 3.0, such over-current protective devices shall comply with IEC 60947-2, IEC 60947-6-2 or IEC 61009-1 or with the relevant parts of IEC 60898 series or IEC 60269 series.

Charging station rated current	32A 1-Phase	16A 3-Phase	32A 3-Phase
Charging station power rating	7.4 kW	11 kW	22 kW
Protection against overload and short circuits	40A curve B or C (2)	20A curve C	40A curve C
Differential protection	30mA type A Si or type B EV	30mA type A Si or type B EV	30mA type A Si or type B EV

(2) According to selectivity with upstream protections

Recommended protection: Acti9 iC60 (If an alternative product is selected, please ensure that it complies with energy limiting class 3.)

- A Undervoltage release (iMNx) controlled by the charging station must be installed to enable to activate the upstream circuit-breaker tripping.
- The protections described below should only be taken as suggestions and Schneider Electric cannot be held liable.

### Recommendations for lightning protection

One surge arrester per charging station is recommended for high keraunic levels, mandatory if required by local regulations.

## Distribution System Operator (DSO)

- According to Technical Connection Rules VDE-AR-N-4100:2019-04 Cl. 10.6.4, a charging station with a total rated power of more than 12 kVA must have a remote power control interface to allow remote Control by the Distribution System Operator (DSO).
  - A dry connector for DSO input to suspend the Schneider charge.
  - Input connector for DSO cable: 0.2-1.5 mm<sup>2</sup> (AWG 24-15.5) flex and rigid cable.
  - Schneider charge DSO input supports only Normally Open (NO) configuration:
    - Contact open: Charge allowed
    - Contact closed per the utility: Charge suspended

## Power Cable Requirements

- For wiring section "Wiring", page 12, please comply with local regulations.
- The maximum wire gauge should not exceed 10 mm<sup>2</sup> (AWG 7).
- Two types of wire as recommended when connecting the charging station to the power supply:
  - To use flexible cables.
  - To use rigid cable.

1-phase installations

	Distribution board	Undervoltage Release (iMNx)	Distribution System Operator (DSO)
Diameter	3 x 6 mm <sup>2</sup> (3 x AWG 9) (Type U1000R2V 3G)	2 x 0.5 mm <sup>2</sup> (2 x AWG 20)	2 x 0.5 mm <sup>2</sup> (2 x AWG 20)
Length	< 50 meters (164.04 ft)	< 30 meters (98.43 ft)	< 30 meters (98.43 ft)

3-phase installations

	Distribution board	Undervoltage Release (iMNx)	Distribution System Operator (DSO)
Diameter	5 x 6 mm <sup>2</sup> (5 x AWG 9) (Type U1000R2V 5G)	2 x 0.5 mm <sup>2</sup> (2 x AWG 20)	2 x 0.5 mm <sup>2</sup> (2 x AWG 20)
Length	< 50 meters (164.04 ft)	< 30 meters (98.43 ft)	< 30 meters (98.43 ft)

## ⚠️ ⚠️ DANGER

### HAZARD OF ELECTRIC SHOCK, EXPLOSION OR ARC FLASH

- Do not install automatic reset systems on the residual current protection device.
- Disconnect the mains power supply before working on the charging station.
- Use a Voltage Tester of appropriate rating.
- Do not turn on the charging station if the earth resistance measured is higher than the threshold defined in the enforceable regulations.
- Connection to a Undervoltage release (iMNx). It is not supplied with the charging station.
- Do not connect to an IT earthing system if the voltage exceeds 240Vac
- Install the over-current and residual current protections upstream of Charging station.
- Do not use a system which automatically resets the residual current circuit breaker.

**Failure to follow these instructions will result in death or serious injury.**

**i** Ensure that the grounding wire is reliably connected.

**i** TIC interface is limited to EVH5A22N400F.

### 220-240V 1-phase

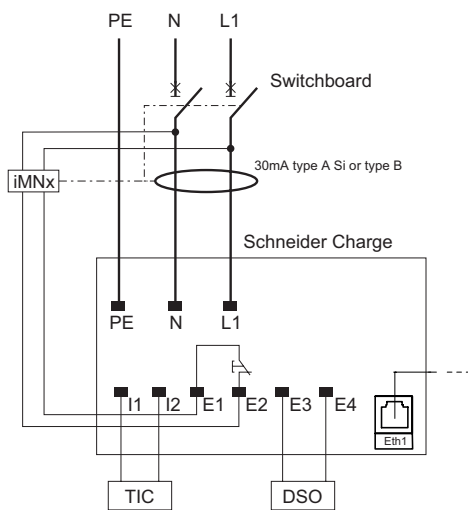

### 380-415V 3-phase

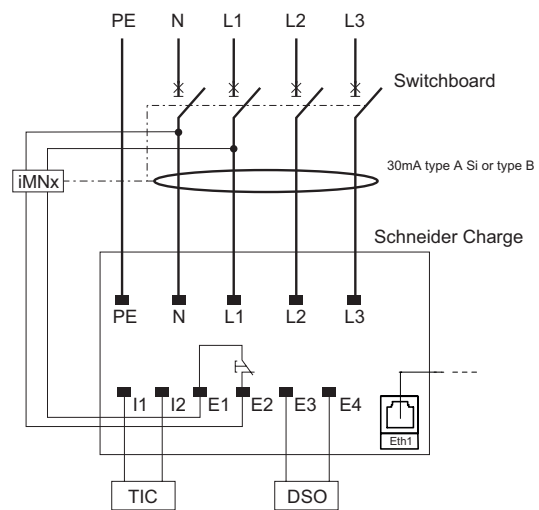

### 220-240V 1-phase No Neutral\*

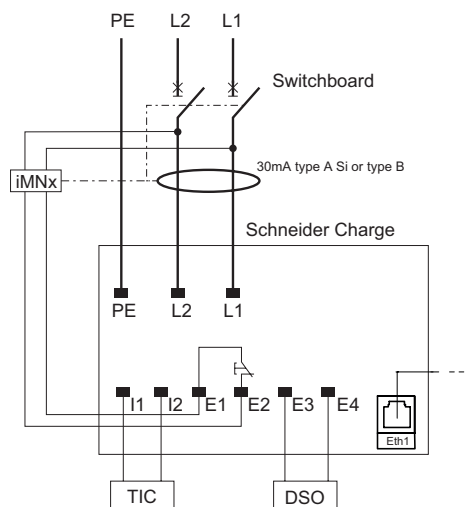

\* For application in IT power grid

iMNx: Undervoltage release

# 6 Installation

## 6.1 Equipment Supplied by User

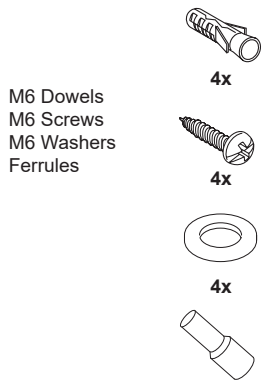

## 6.2 Tools Supplied by User

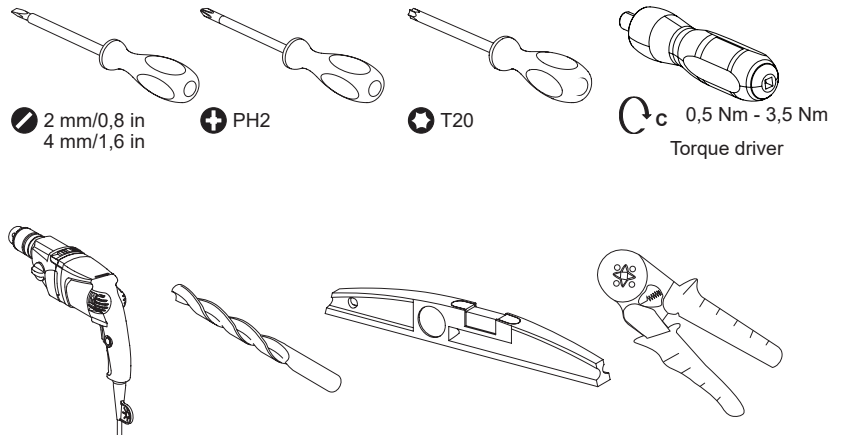

### ⚠️ ⚠️ DANGER

#### HAZARD OF ELECTRIC SHOCK, EXPLOSION OR ARC FLASH

Do not install the charging station in explosive environment.  
Failure to follow these instructions will result in death or serious injury.

### ⚠️ WARNING

#### RISK OF DAMAGING THE CHARGING STATION

- Do not perform the installation outside in rainy weather without protection from the rain.
  - Protect the charging station from dust and water while fixing the bracket.
  - Attach the charging station to a flat surface.
  - Use screws, washers and wall plugs suitable for the wall material.
  - Screw head thickness should be less than 5,5 mm.
- Failure to follow these instructions can result in death, serious injury, or equipment damage.

## 6.3 Wall Mounting

**i** Ensure there is enough space on right side of mounting position to operate side button and observe side LED.

Cable entry from the bottom

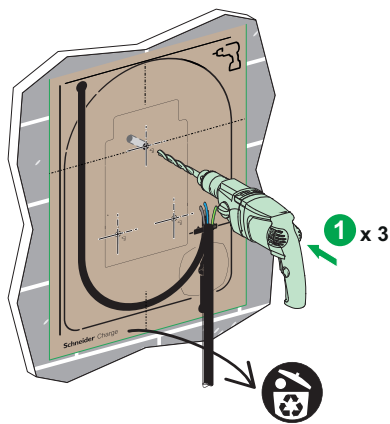

Cable entry through the wall

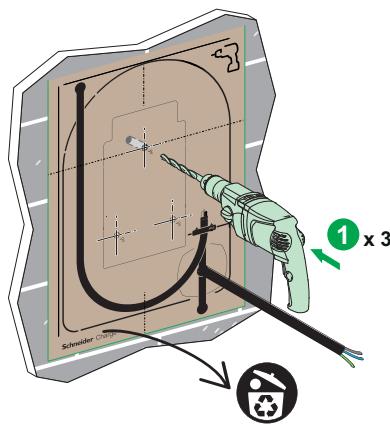

Cable entry from the top

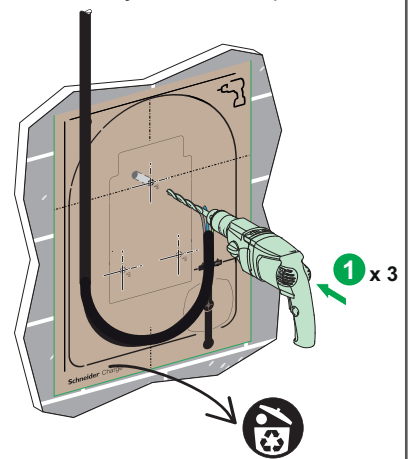

**i** Use spacers  if your wall is irregular.

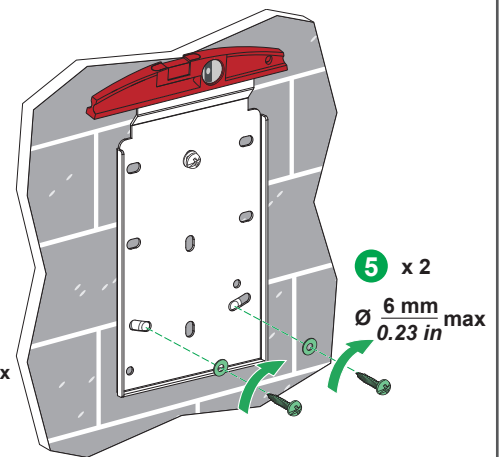
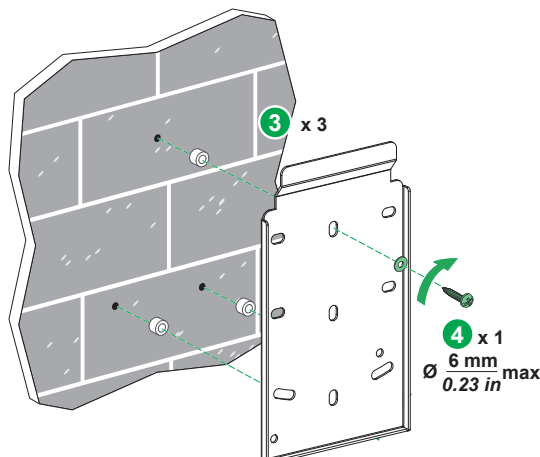
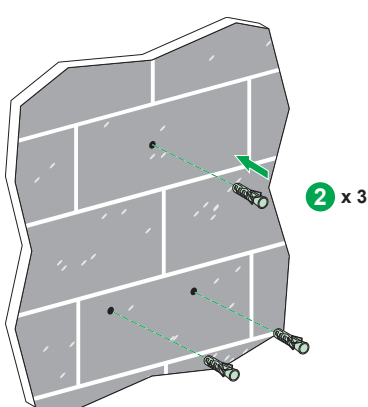

# 6 Installation

## 6.3 Wall Mounting

**i** If the power cable enters from the top, please open this knock-down hole.

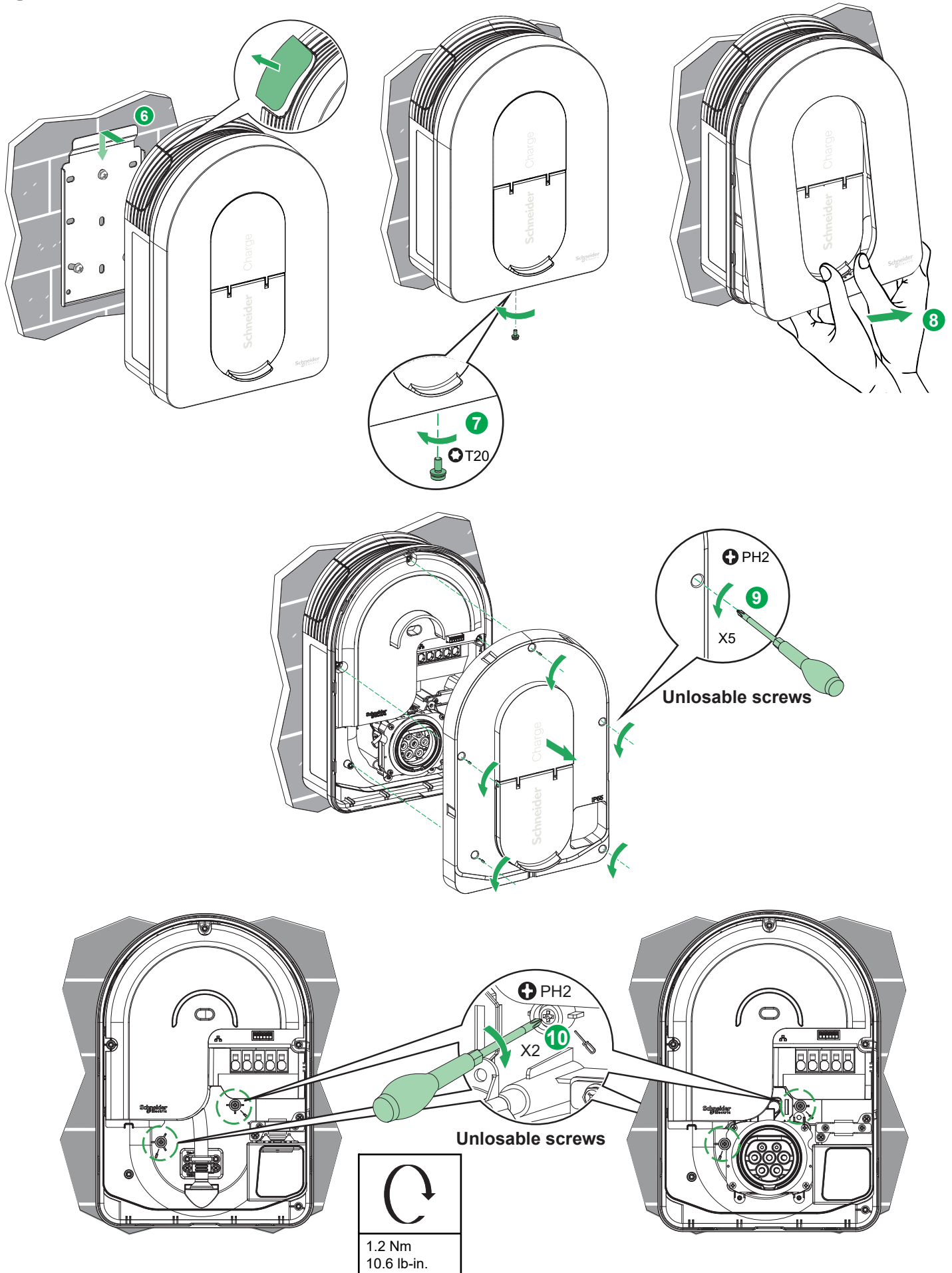

# 6 Installation

## 6.4 Wiring

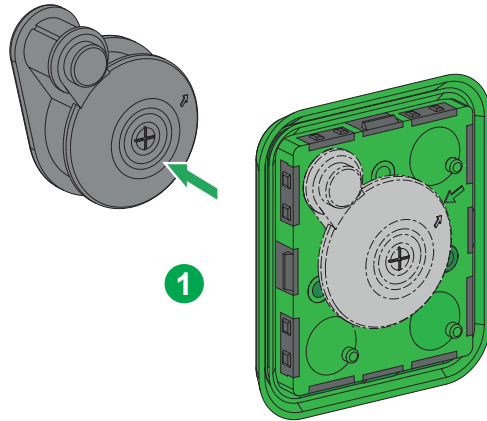

**i** Choose 1 gasket according to power cable diameter.  
If gasket-small is chosen, cut the hole size according to your cable diameter.

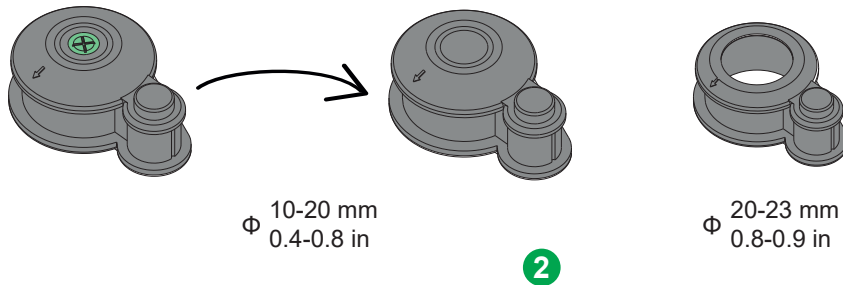

**i** Skip step 3-7, 11 if no use of Ethernet cable.

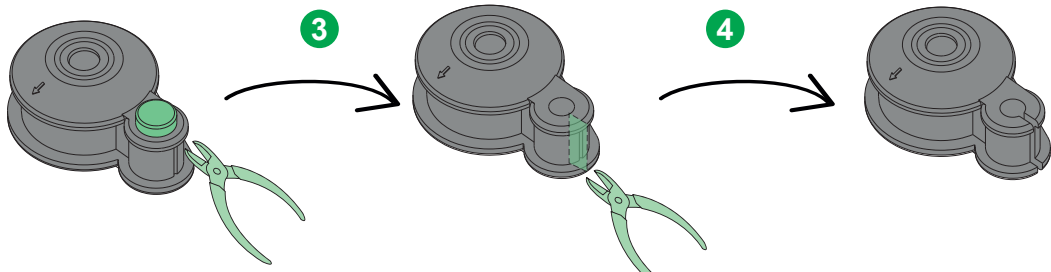

**i** Do not reverse gasket direction.

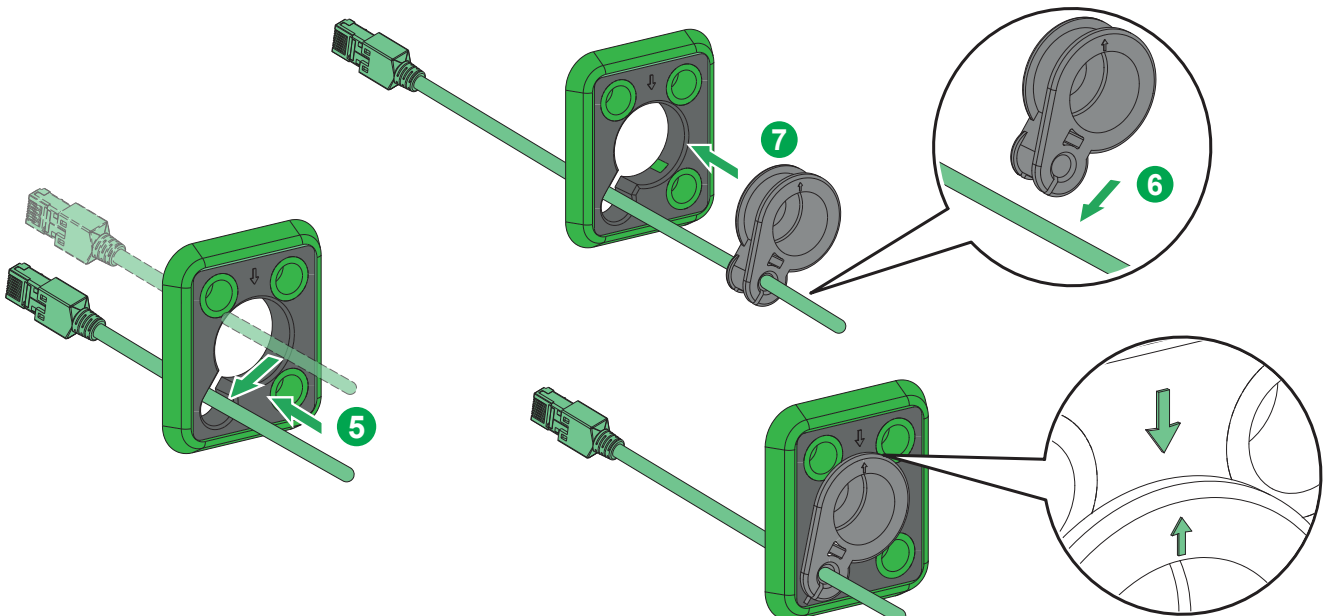

# 6 Installation

## 6.4 Wiring

**i** Skip step 8 if no use of iMNx/TIC/DSO.

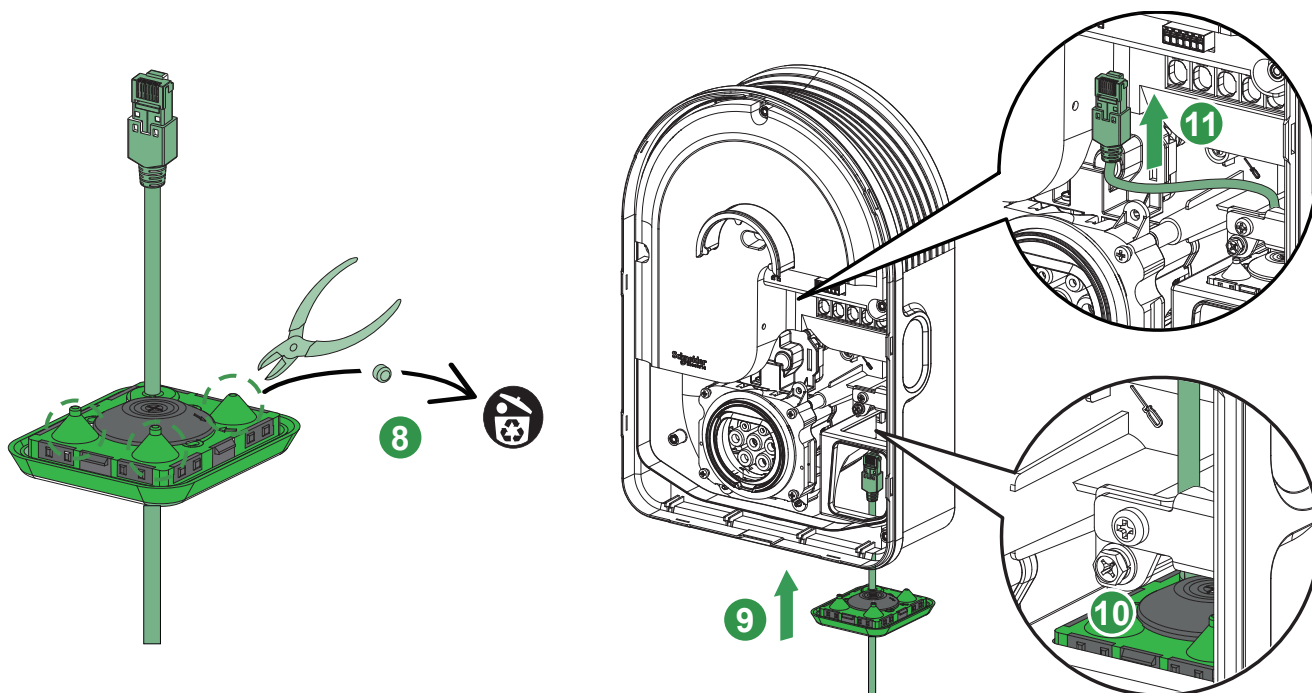

### Routing of cables

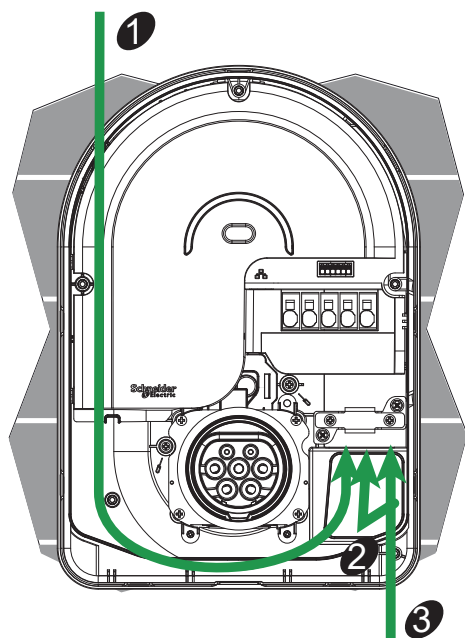

### Three cabling possibilities

- 1 Cable entry from the top
- 2 Cable entry through the wall
- 3 Cable entry from the bottom

# 6 Installation

## 6.4 Wiring

Cable diameter: 10-20mm

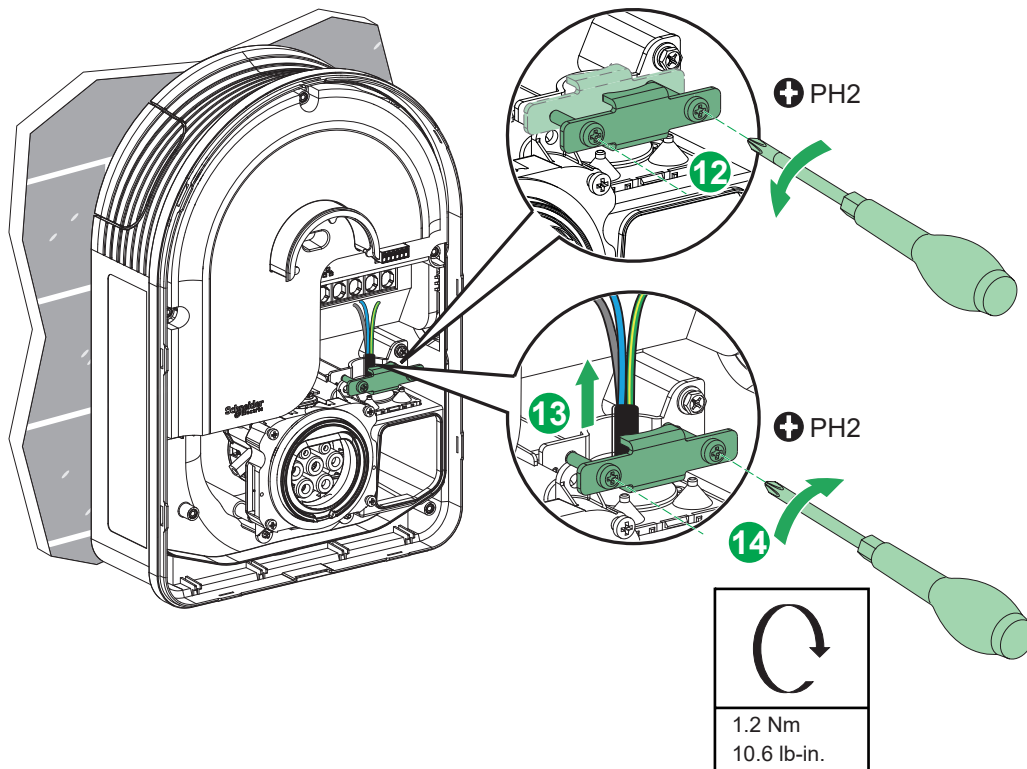

Cable diameter: 20-23mm

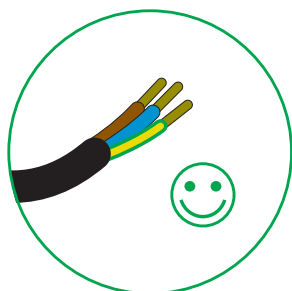
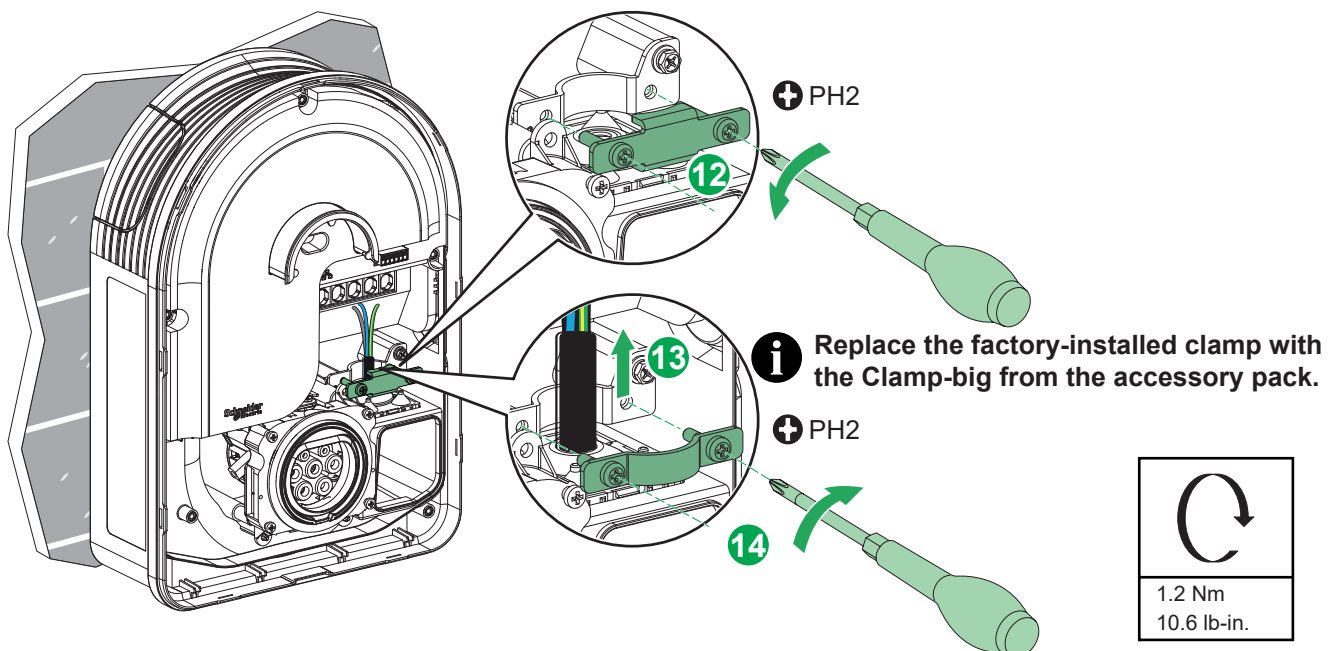

Cable connection type	Cable section	
Flexible cable	2.5-10 mm <sup>2</sup> AWG 13.2-7	19 mm 0.75 in
Rigid cable	2.5-10 mm <sup>2</sup> AWG 13.2-7	19 mm 0.75 in

# 6 Installation

## 6.4 Wiring

### iMNx/TIC/DSO wiring

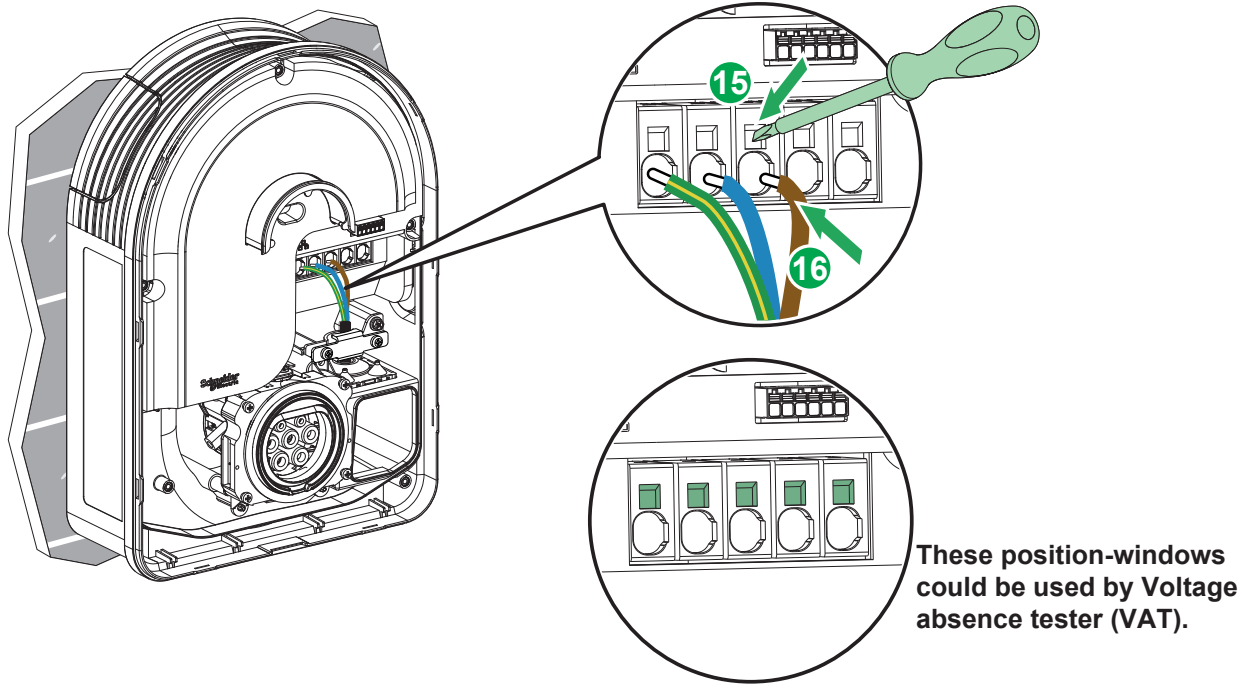

### NOTICE

#### INOPERABLE EQUIPMENT

- DSO terminals must only be connected to dry contacts without voltage.
  - iMNx terminals from the charging station must only be connected to E1 E2 iMNx or MNx terminals, excluding any other tripping device.
- Failure to follow these instructions can result in equipment damage.

**i** Skip step 17-19 if no use of iMNx/TIC/DSO.

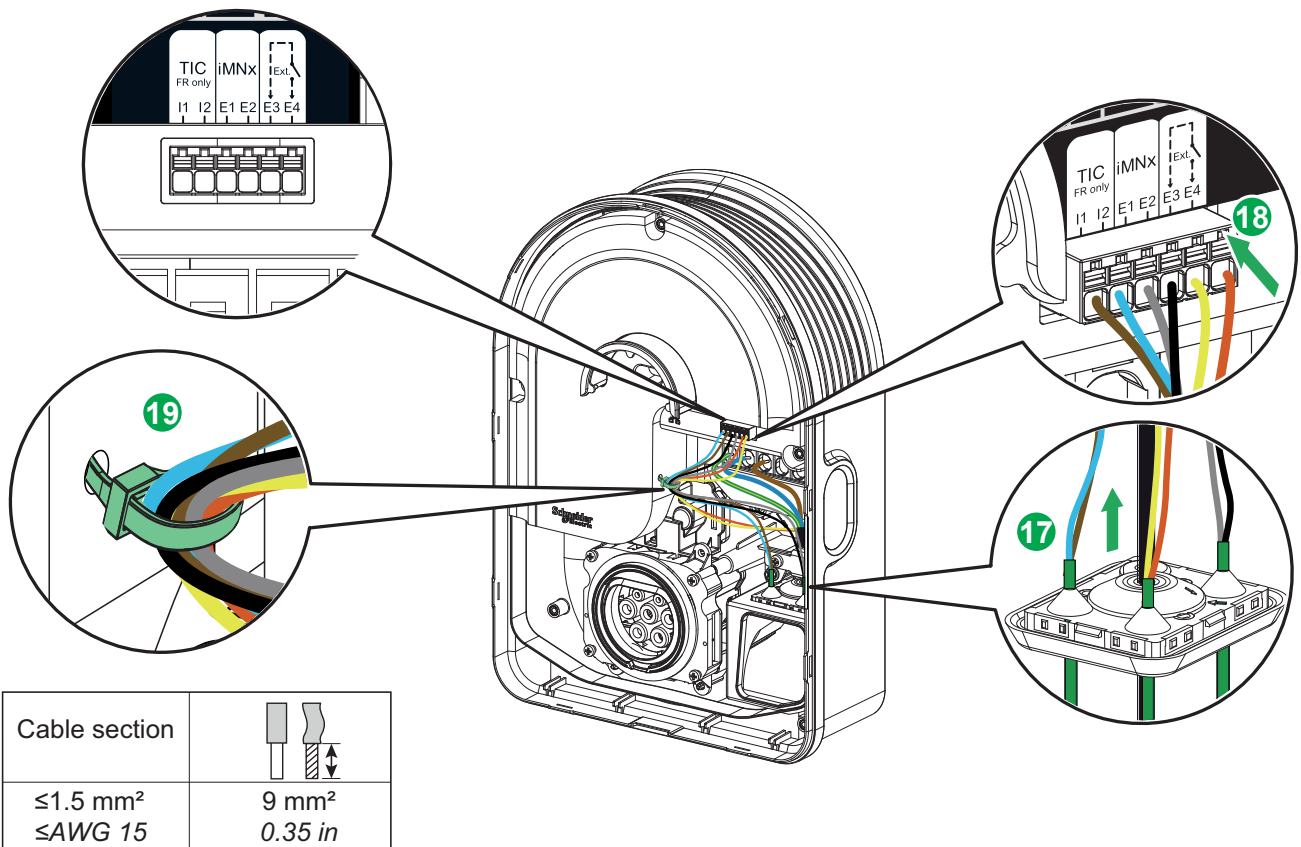

# 6 Installation

## 6.4 Wiring

**i** Select a safety label to install according to the required language.

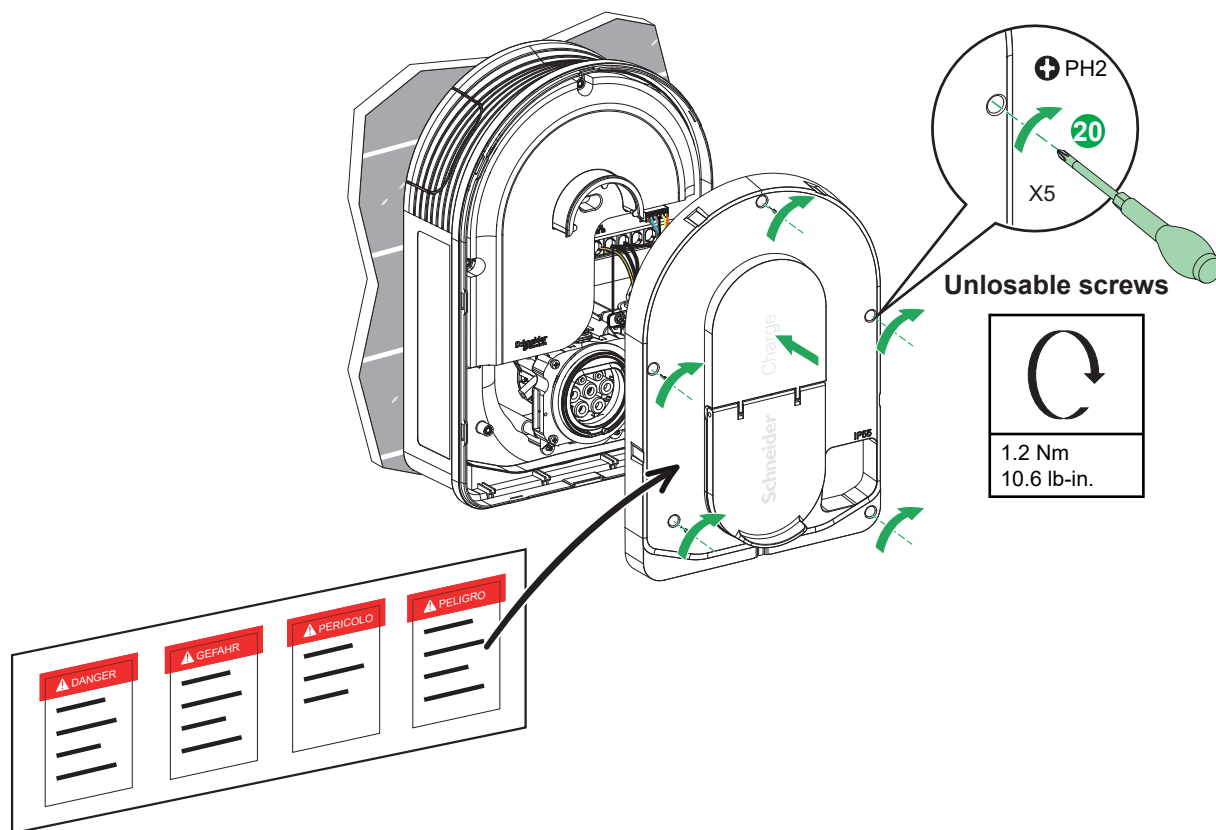

**i** In case of loss of the screw, an another piece is delivered in the accessories box.

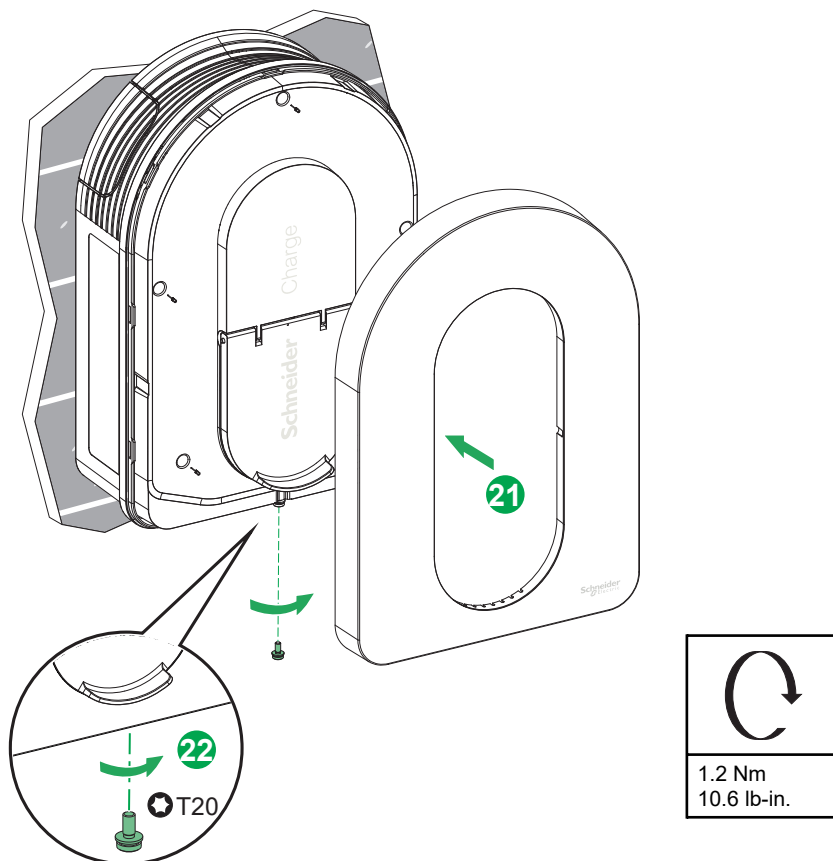

# 7 Connection

## 7.1 Wire-up Signal Line

**i** TIC interface is limited to EVH5A22N400F.

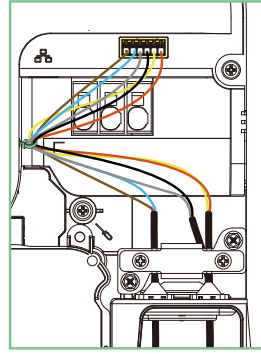
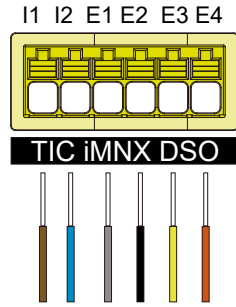

## 7.2 Wire-up Power Supply

### 220-240V AC 1-phase

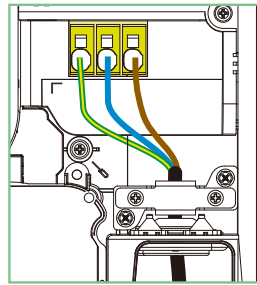
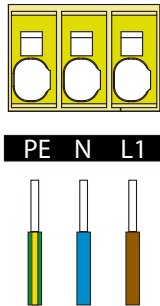

### 380-415V AC 3-phase

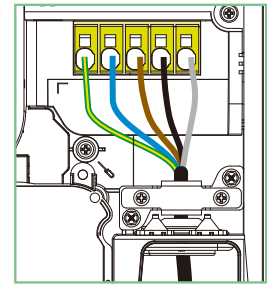
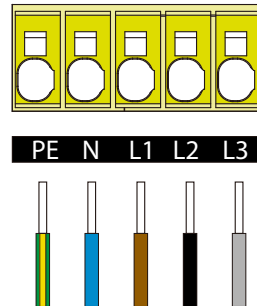

**i** When power supply is single-phase, please follow the wiring method with 1-phase Schneider Charge.

### 220-240V AC 1-phase No Neutral\*

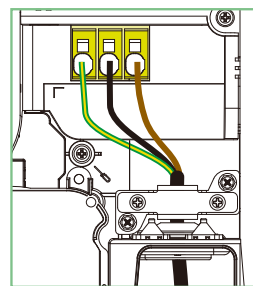
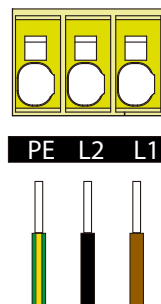

\* For application in IT power grid

# 8 Inspection

**⚠ ⚠ DANGER**

### HAZARD OF ELECTRIC SHOCK, EXPLOSION OR ARC FLASH

Wear suitable personal protective equipment (PPE) and follow all safety procedures.

Failure to follow these instructions will result in death or serious injury.

- Check that the inspection hatch is correctly screwed down.
- Ensure that the power cable is securely fastened by the crimping collar.
- Check that the cover of the charging station is intact and hasn't suffered any obvious mechanical damage or deformation.
- Check that the charging station is securely fastened to the wall.
- Check that nothing is impeding the connection of the charging cable to the charging station socket.

### 9.1 Commissioning with eSetup Application

Prerequisites

**Material needed:** Ethernet cable, Wi-Fi repeater, iOS or Android smartphone

**Wire the charging station**

In case a load management option must be used, it is preferable to install it before starting the commissioning. Refer to the anti-tripping module user manual.

**Check the connection to the domestic network (internet router)**

It is recommended to use a wired Ethernet connection when the Schneider Charge is located outdoors or beyond the internet router's or Wi-Fi repeater's range. For Wi-Fi connection, make sure that the Wi-Fi is 2.4 GHz and check the Wi-Fi signal strength.

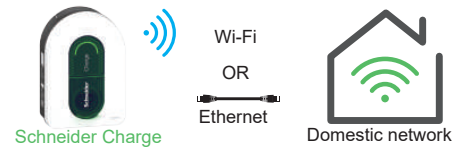

**Download the eSetup for electrician application on your smartphone**



**Check your smartphone permissions**

- Go to Settings > Privacy & Security > Location Services. Make sure that Location Services is on.
- Go to Location and make sure that Precise location is on.
- For iPhone, Go to Setting > Privacy & Security > Local Network and make sure that Local Network for eSetup is on.
- Enable Wi-Fi on your smartphone.



**Download the latest firmware version**

The firmware of the charging station must be up to date before performing the commissioning. Download the latest firmware version of the charging station in the Firmware Manager of the eSetup application.

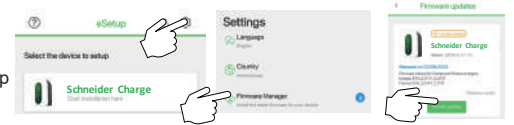

#### 9.1.1 Connect & Update

1

**Charging station initialization**

Power ON the charging station. It takes 30 seconds to be ready. The front indicator light turns from solid white to solid green.

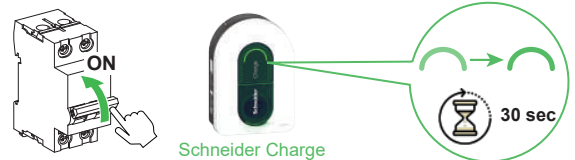

2

**Charging station Wi-Fi access point activation**

When the side indicator light is solid green, press the side button for 3 seconds. If the side indicator light is Off, power the charging station Off and then back On to re-activate the side button. The side indicator light blinks green when the Wi-Fi access point of the charging station is activated for commissioning. The front indicator light breathes green during the commissioning.

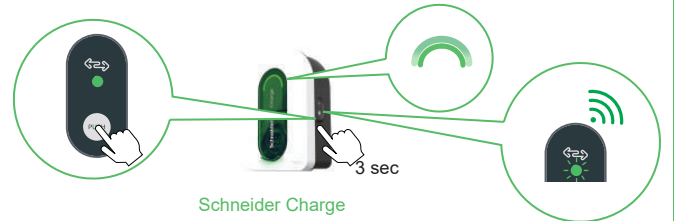

3

**Commissioning application launch**

Open the eSetup for electrician application and select Schneider Charge in the menu. Accept permission requests on your smartphone (see prerequisites).

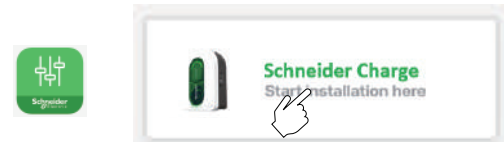

4

**Connection to charging station Wi-Fi access point**

Scan the QR code on the Wi-Fi access point sticker with your camera, or Select Schneider Charge in the Wi-Fi settings of your smartphone and enter the charging station Wi-Fi password manually. **Remove the sticker when finished and keep the Wi-Fi information in a safe place.**



5

**Cybersecurity of the charging station**

Create and confirm your charging station PIN code. Write it down in the user manual so that it is not lost.



6

**Firmware update**

If the charging station firmware is not up to date, continue to do the upgrade.
 

- The front indicator light blinks green during the upgrade.
- The charging station automatically restarts and configures the new firmware.
- The front indicator light breathes green when ready to continue the commissioning.

**Do not power off the charging station during the upgrade process.**

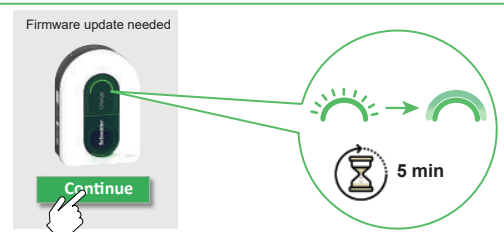

# 9

## Commissioning with Application

### 9.1.2 Configure Electrical Settings

**7 Connection to the charging station**  
 The front indicator light breathes green when the charging station Wi-Fi access point is ready for commissioning. If not, go back to step 2.  
 Log in with the PIN code to reconnect to the charging station.  
 In case the PIN code is lost, a new one can be created by clicking on "Reset PIN code" and following the instructions in eSetup.

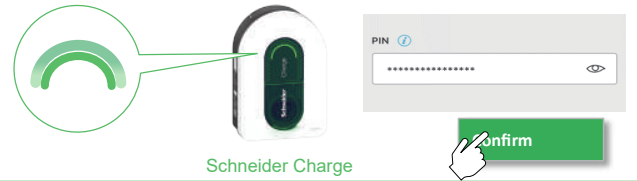

**8 Electrical settings**  
 Adjust the value to set the maximum current that will be provided to the electric vehicle during the charge.  
 In case a load management solution is used (Anti-tripping module) then the charging station will dynamically adjust the charging power to avoid tripping the house.

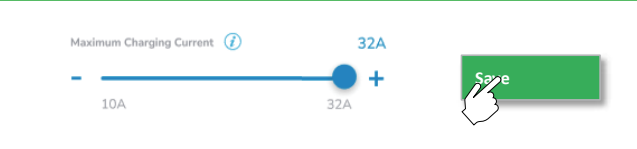

### 9.1.3 Pre-configure the Smart Charging Application (Optional)

**9 Connection to the smart charging application**  
 In eSetup application, tap on the toggle to enable the pre-configuration of the charging station for the connection to the smart charging application.

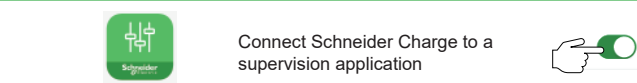

**10 Connectivity to the domestic network**  
 Select the mode of connectivity to the domestic network:  
 - Wi-Fi  
 - Ethernet  
 For Wi-Fi connection, make sure that the Wi-Fi of the internet router is 2.4 GHz and check the Wi-Fi signal strength. Add a Wi-Fi repeater if needed.



**11 Network Settings of the domestic network (internet router)**  
 For connection to the internet router with Wi-Fi:  
 - scan the internet router QR code,  
 - or enter the router Wi-Fi name and password manually.  
 Click the save button. The charging station checks the connection to the internet router. If not successful, check the internet router Wi-Fi signal strength, name and password.

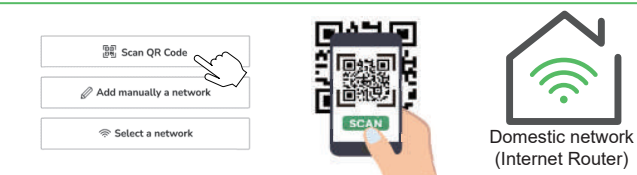

**12 Smart charging application settings**  
 In eSetup application, confirm or configure the smart charging application for the user.  
 Please see section "Connection to a smart charging application" below for details.

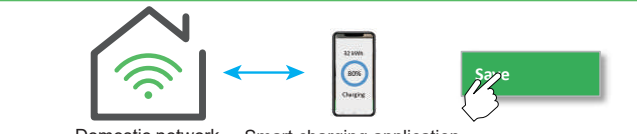

### 9.1.4 Finalize

**13 Handover**  
 Send the report to the client by SMS or email.  
 It contains information for the client to connect to the smart charging application and to reconnect to the charging station whenever needed.  
 The Charge Point Identification number (CPID) might be requested to the end user by the smart charging application.  
 The CPID number can be found in the report or on the label on the side of the charging station.

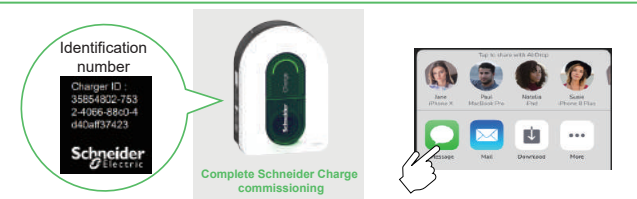

**14 Restart the charging station**  
 At the end of the commissioning, the charging station automatically restarts to validate the new settings.  
 When a smart charging application is selected, the front indicator light turns solid green when the charging station is connected to the internet router.  
 If the front indicator light is still breathing orange after 1 minute, please refer to the troubleshooting section in the user manual.



### 9.1.5 Ready to Operate

#### Ready to use!

The charging station is now ready to charge an electric vehicle!  
 When a smart charging application is pre-configured, the charging station can then be connected to the smart charging application account of the client.



### 9.2 Commissioning with Wiser Home Application

#### Prerequisites

**Material needed:** Ethernet cable, Wi-Fi repeater, iOS or Android smartphone

**Wire the charging station**

In case a load management option must be used, it is preferable to install it before starting the commissioning. Refer to the anti-tripping module user manual.

**Check the connection to the domestic network (internet router)**

It is recommended to use a wired Ethernet connection when the Schneider Charge is located outdoors or beyond the internet router's or Wi-Fi repeater's range. For Wi-Fi connection, make sure that the Wi-Fi is 2.4 GHz and check the Wi-Fi signal strength.

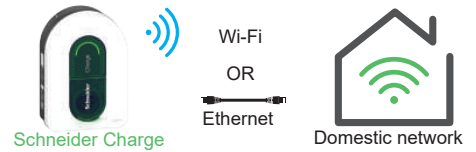

**Download the Wiser Home application on your smartphone**

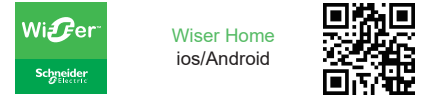

### 9.2.1 Connect & Update

1

**Get started and download the latest firmware version**

Once started, select "Professional Installer", country or region, and "Schneider Charge" respectively. Download the latest firmware version of the charging station to your mobile phone.

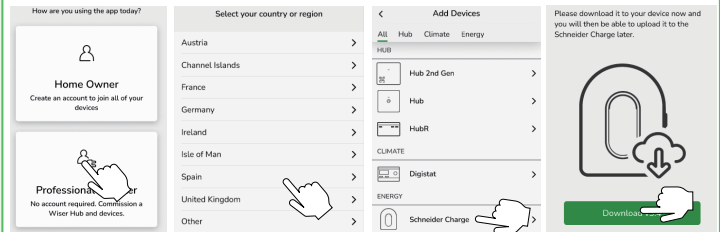

2

**Connect to Wi-Fi direct**

Click "Start setup" after download is successful. Turn off the device through the circuit breaker. Wait 10 seconds, then power it ON again. It takes 30 seconds to be ready. The front indicator light turns from solid white to solid green.

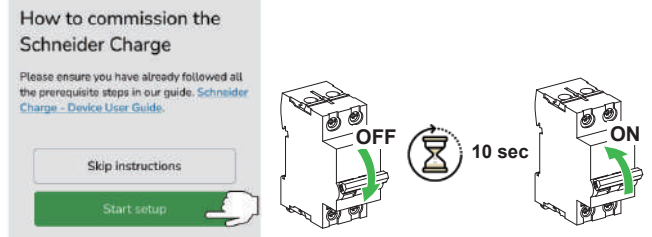

3

**Charging station Wi-Fi access point activation**

When the side indicator light is solid green, press the side button for 3 seconds. If the side indicator light is Off, power the charging station Off and then back On to re-activate the side button. The side indicator light blinks green when the Wi-Fi access point of the charging station is activated for commissioning. The front indicator light breathes green during the commissioning.

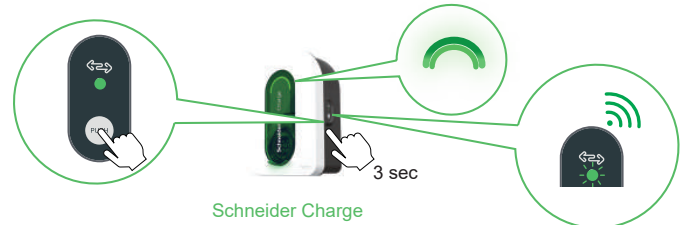

4

**Connection to charging station Wi-Fi access point**

Click "Open camera" and authorise "Wiser Home" to access to your camera. Scan the QR code on the Wi-Fi access point sticker with your camera. Remove the sticker when finished and keep the Wi-Fi information in a safe place.

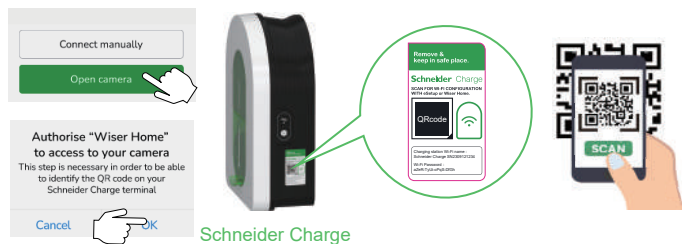

5

**Cybersecurity of the charging station**

Create and confirm your charging station PIN code. Write it down in the user manual so that it is not lost. Log in with the PIN code to connect to the charging station.

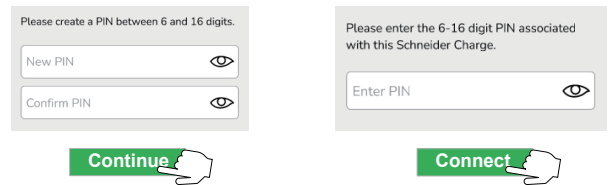

6

**Firmware update**

If the charging station firmware is not up to date, continue to do the upgrade.  
 - The front indicator light blinks green during the upgrade.  
 - The charging station automatically restarts and configures the new firmware.  
 - The front indicator light breathes green when ready to continue the commissioning.  
**Do not power off the charging station during the upgrade process.**

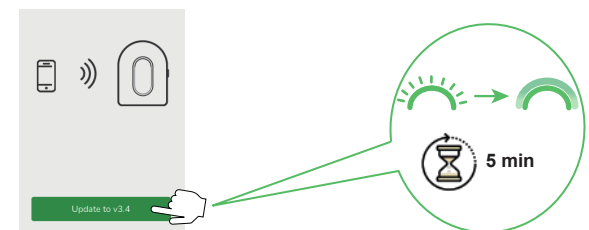

# 9

## Commissioning with Application

### 9.2.2 Configure Electrical Settings

7

#### Electrical settings

Adjust the value to set the maximum current that will be provided to the electric vehicle during the charge. In case a load management solution is used (Anti-tripping module) then the charging station will dynamically adjust the charging power to avoid tripping the house.

Maximum charging current

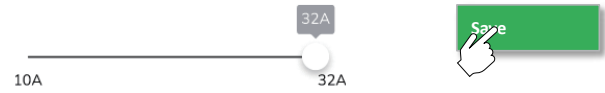

### 9.2.3 Configure Network Settings (Optional)

8

#### Connectivity to the home network

Select the mode of connectivity to the home network:

- Wi-Fi
- Ethernet

For Wi-Fi connection, make sure that the Wi-Fi of the internet router is 2.4 GHz and check the Wi-Fi signal strength. Add a Wi-Fi repeater if needed.

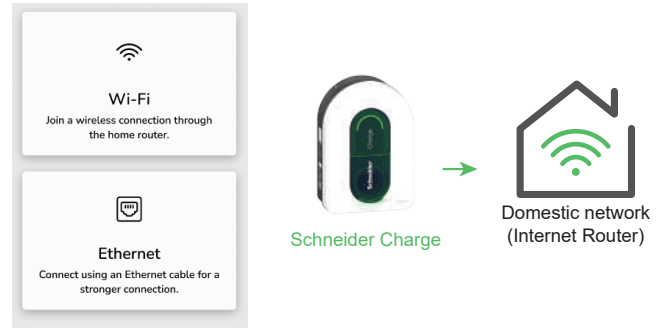

### 9.2.4 Finalize

9

#### Restart the charging station

At the end of the commissioning, the charging station automatically restarts to validate the new settings. When a smart charging application is selected, the front indicator light turns solid green when the charging station is connected to the internet router. If the front indicator light is still breathing orange after 1 minute, please refer to the troubleshooting section in the user manual.

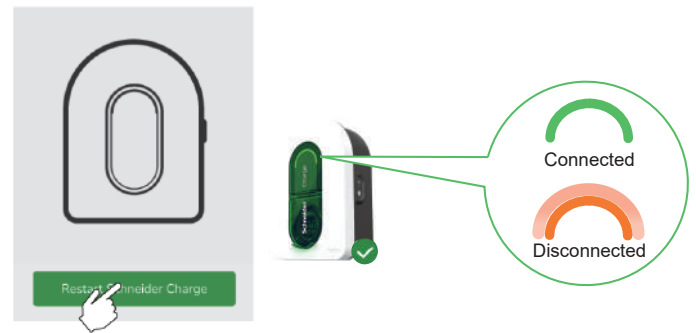

10

#### Handover

Send the report to the client by SMS or email. It contains information for the client to connect to the Wiser Home application and to reconnect to the charging station whenever needed.

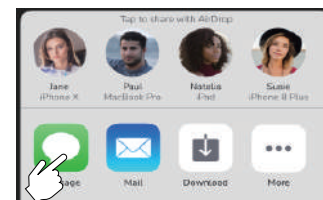

### 9.2.5 Ready to Operate

#### Ready to use!

The charging station is now ready to charge an electric vehicle! When the Wiser Home application is pre-configured, the charging station can then be connected to the Wiser Home application account of the client.

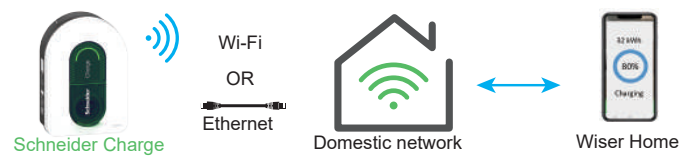

# 10 Operation

## ▲ CAUTION

### RISK OF INJURY

Do not use any extension cable or adaptor to connect the charging station to the electric vehicle.  
**Failure to follow these instructions can result in injury, or equipment damage.**

## 10.1 Connecting the Electric Vehicle Charging Station

- Connect the charging cable's plug into the Electric Vehicle charging station's socket.
- Connect the charging cable's connector into the Electric Vehicle's inlet.
- The charge's LED indicator will change from a solid green to pulsing blue.

## 10.2 Disconnecting the Electric Vehicle

## ▲ WARNING

### RISK OF INJURY

Do not use brute force to unplug the charging connector from the Electric Vehicle as it is mechanically locked.  
**Failure to follow these instructions can result in death, serious injury, or equipment damage.**

- Stop the charging session via the Electric Vehicle to unlock the connector.
- Unplug the charging station's connector from the Electric Vehicle's inlet.
- Wind the charging cable around the Electric Vehicle charging station's winding trough.

## 10.3 Connection to a Smart Charging Application

When connected to a smart charging application, the charging station can be controlled remotely.

Scheduling and history functions help to optimize the charging cost.

The smart charging application will help to update the software of the charging station for a better charging experience.

Note: some control features might be available in the charging station but not in the smart charging application or vice-versa.

### 10.3.1 Prerequisites

#### Pre-configuration of the charging station

Make sure that the smart charging application option has been activated during the commissioning with eSetup application (steps 9 to 12 above).  
The charging station is then pre-configured with the smart charging application URL address.  
If not, contact your electrician or a qualified person.



#### Locate the Charge Point Identification number (CPID)

The identification number of the charging station - or Charge Point Identification number (CPID) - is mentioned in the SMS or email sent to you by the electrician at the end of the commissioning with eSetup application.  
It can also be found on the label on the left side of the charging station or by scanning the QR code next to it and by clicking on "+ More details".  
**The identification number of the charging station will be requested to connect the charging station to the smart charging application.**



Charging Station Identification number

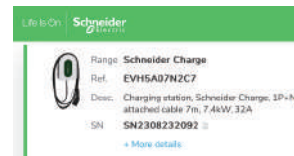

#### Connection to domestic network

Make sure that the charging station is connected to domestic network.  
The front indicator light should be solid green.  
Refer to the troubleshooting section if needed.



Wi-Fi

OR



Ethernet



Domestic network

## 10.3 Connection to a Smart Charging Application

### 10.3.2 Connect

**1 Download the smart charging application**

Download the smart charging application on your smartphone **using the links sent to you by the electrician** by SMS or email at the end of the commissioning with eSetup application.

Wiser Home is a free application from Schneider Electric to manage energy and electric vehicle charging at Home in France, Germany, Spain, Australia, Portugal, New Zealand.

Monta is one of the smart charging application available in most countries.

**The application to download should correspond to the one pre-configured by your electrician in your charging station.**

**2 Create a user account**

Create a user account in the smart charging application. Refer to terms of use and on the on-line help in the smart charging application. Note: Applications other than Wiser Home are non-Schneider electric applications.

Name: Clara  
email: clara@EVdriver.com  
pw: \*\*\*\*\*

Smart charging application

**3 Connection of your charging station**

Create your charging station in your personal account and connect it using the Charge Point Identification number (CPID).

CPID example: b1820131-9750-41a5-9f87-9a7ebd2f2511

**Note: Use the Charge Point Identification number (CPID) to connect with the smart charging application, not the Serial Number!**

When using Wiser Home application, simply scan the QR code on the front cover of the charging station.

Charge Point Identification number

Smart charging application

### 10.3.3 Ready to Operate Remotely

**Ready to use!**

The charging station is now ready to charge an electric vehicle and operate with its smart charging application!

**Reading the full device guide online**

- Scan the QR code based on your country or location and choose your language.
- For complete information about the device, including operation, configuration and using the product with a Wiser system.

→

Australia

→

New Zealand

→

# 11 Cable Storage

**⚠️ ⚠️ DANGER**

**HAZARD OF ELECTRIC SHOCK, EXPLOSION OR ARC FLASH**







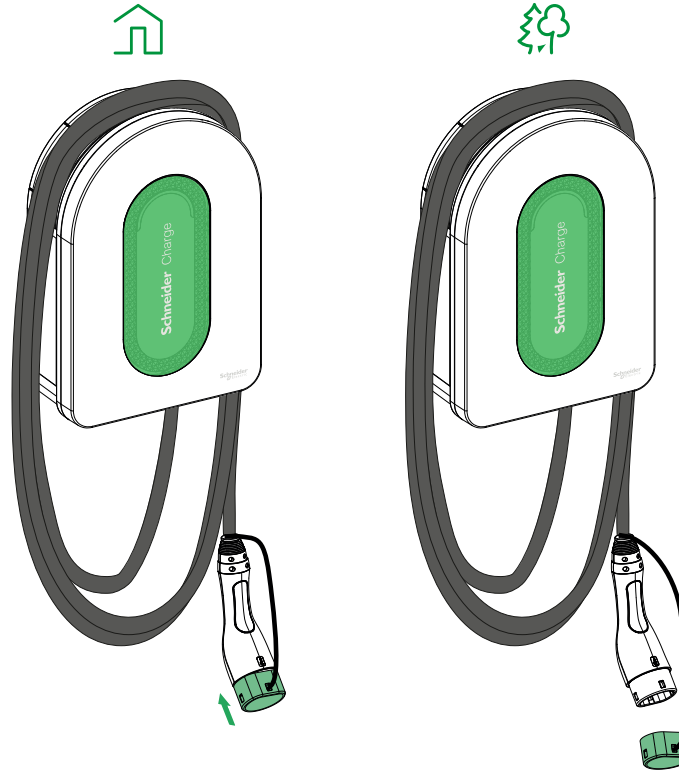



Regularly check the integrity of the cable.







**Failure to follow these instructions will result in death or serious injury.**

- Ensure that the charging connector and charging cable are securely stored between charging sessions.
- Wrap the charging cable around the charging station's cable trough.
- If the Schneider Charge is installed outdoors, remove the cap in order to prevent water entering the connector.
- If the Schneider Charge is installed indoors, protect the connector by covering it with the dust cap.
- It is recommended to use Schneider Charge Gun Holder (EVA5GH) to hold the connector during non-charging sessions.









# 12 Charging Station Indicators

 Front Indicator Light	Charging station status	
	Solid White	Restart of the charging station - Please wait!
	Breathing Green	Wi-Fi access point activated for commissioning
	Blinking Green	Firmware upgrade on going - Please wait!
	Solid Green	Ready
	Breathing Blue	Charging on going
	Blinking Blue	Charge suspension by the smart charging application or lack of remaining power in the house
	Solid Blue	Charge suspension by electric vehicle or battery full or charging session preparation or DSO input
	Breathing Orange	Not connected to the smart charging application when connectivity configured
	Solid Orange	Locked
	Solid Red	Stop/Error - Refer to trouble shooting section

 Side indicator light	Charging station status	
	No light	PUSH button not activated - Power off and then back on the charging station to activate it
	Solid Green	Ready to activate Wi-Fi access point for commissioning/ Ready to enter in pairing mode with anti-tripping module (peak controller)
	Blinking Green	Wi-Fi access point activated for commissioning
	Blinking Blue	Pairing mode with anti-tripping module (peak controller) activated
	Blinking Red	Anti-tripping module power line communication lost

# 13 Basic Troubleshooting

Symptom	Possible causes and solutions
 Connector plugged into electric vehicle but not charging, LED illuminated solid green	<ul style="list-style-type: none"> <li>■ Verify that the connector was inserted properly by unplugging and plugging it back into the electric vehicle's socket.</li> <li>■ Verify the charging sequence by following the procedure described in section "Operation".</li> </ul>
 Connector plugged into electric vehicle but not charging, LED illuminated Blinking blue	<ul style="list-style-type: none"> <li>■ Verify that you do not have a schedule in progress through the smart charging application that prevents charging the car.</li> <li>■ In case you have installed an anti-tripping module. The anti-tripping module limits the maximum power draw of the Schneider Charge and can completely stop the charge to avoid a power outage of your home electrical supply under all conditions. Reduce the home load to have at least 9A current available per phase to restart charging the car. Be sure you have enough power in your electricity subscription for charging the car and for the house loads. You probably need to increase the electricity subscription of your electrical installation.</li> </ul>
 Connector plugged into electric vehicle but not charging, LED illuminated Solid blue	<ul style="list-style-type: none"> <li>■ Verify that you do not have a schedule in progress through your car that prevents charging the car.</li> </ul>
 Charging station's LED breathing Orange	<ul style="list-style-type: none"> <li>■ Restart the Schneider Charge.</li> <li>■ The Schneider Charge is not connected to the domestic network when using Wi-Fi:                             <ul style="list-style-type: none"> <li>□ Verify that you have connected the Schneider Charge to a 2.4 GHz Wi-Fi with WPA2 password.</li> <li>□ Verify that the Wi-Fi name and password are correct.</li> <li>□ In case the Wi-Fi signal is too weak: connect the charging station with Ethernet cable, or add a Wi-Fi repeater.</li> </ul> </li> <li>■ Verify that internet router is working properly.</li> </ul>
 Charging station's LED illuminated red	<ul style="list-style-type: none"> <li>■ Switch off the power supply to the charging station, unplug the connector from the electric vehicle, reconnect the power supply, wait for the charging station to become ready (LED illuminated solid green), before reconnecting the connector to the electric vehicle. In case of recurrence, please contact Schneider Electric's Customer Care Centre.</li> </ul>
 Charging station's LED off	<ul style="list-style-type: none"> <li>■ No power supply. Verify that the cabling is correct and that circuit breaker did not trip.</li> <li>■ Otherwise, switch off the power supply to the charging station, The charging station is possibly damaged. Please contact Schneider Electric's Customer Care Centre.</li> </ul>
 Charging station's LED White light flashing and then power off	<ul style="list-style-type: none"> <li>■ Power supply overvoltage seriously (Voltage more than 300V between phase line and neutral line). Switch off the power supply to the charging station, The charging station is possibly damaged. Please check power voltage.</li> </ul>
QR code sticker for Wi-Fi access point password is lost	<ul style="list-style-type: none"> <li>■ The Wi-Fi access point password to connect commissioning application (Wiser Home or eSetup) to perform the configuration or modify the settings can be recovered inside the product by removing the front cover.</li> </ul>
PIN code for commissioning application (Wiser Home or eSetup) is lost	<ul style="list-style-type: none"> <li>■ A new PIN Code can be created by clicking on "Reset PIN code" and follow the instructions in commissioning application (Wiser Home or eSetup).</li> </ul>
Main incomer circuit breaker has tripped	<ul style="list-style-type: none"> <li>■ add an anti-tripping module to allow the load shedder.</li> <li>■ if the anti-tripping module is already installed, check that the setting is correct and that it is correctly paired with the charging station: see anti-tripping module user guide.</li> </ul>
Connect the charging station to a smart charging application unsuccessfully	<ul style="list-style-type: none"> <li>■ When the back-end application requests for the Serial Number, you shall enter the Charger Point Identification number (CPID) that you could find on the side of the charging station.</li> </ul>

# 14 Wireless Feature Declaration

## For Europe (where the CE marking is applicable):

Hereby, Schneider Electric Industries, declares that this electric vehicle charging station Schneider Charge is in compliance with the essential requirements and other relevant provisions of Radio Equipment Directives RED 2014/53/EU.

The EU declaration of conformity for Schneider Charge offer (EV23101601) can be downloaded on: [se.com/docs](https://www.se.com/docs).

- Wi-Fi:
  - Operating frequency bands: 2412 MHz-2472 MHz
  - Maximal RF output power: less than 20 dBm (18.25 dBm)

# 15 Recycle



The packaging materials from this equipment can be recycled.  
 The product and all accessories marked with this symbol are electrical and electronic components that must be disposed of separately from household waste.  
 Please help protect the environment by disposing waste in appropriate containers.  
 Thank you for helping to protect the environment.