

Innovations

and Autumn-Winter Campaign 2020/2021



Joker 6004



NEW

6004 Joker XS self-setting spanner



Application: Hexagon screw heads and bolts with wrench size 7-10 (metric) or 1/4"-3/8" (imperial)

Design: Self-setting spanner with ratchet function; size-adjustable mouth side, parallel smooth jaws, with 30° return angle due to the corner-width rectangular prisms in the mouth; hole for hanging

	mm	mm	mm	mm
05020099001	7-10	1/4"-3/8"	117	7,7

6004 Joker S self-setting spanner



Application: Hexagon screw heads and bolts with wrench size 10-13 (metric) or 7/16"-1/2" (imperial)

Design: Self-setting spanner with ratchet function; size-adjustable mouth side, parallel smooth jaws; with 30° return angle due to the corner-width rectangular prisms in the mouth; hole for hanging

	mm	mm	mm	mm
05020100001	10-13	7/16"-1/2"	154	10

NEW

6004 Joker M self-setting spanner



Application: Hexagon screw heads and bolts with wrench size 13-16 (metric) or 1/2"-5/8" (imperial)

Design: Self-setting spanner with ratchet feature; size-adjustable mouth side, parallel smooth jaws, with 30° return angle due to the corner-width rectangular prisms in the mouth; hole for hanging

	mm	mm	mm	mm
05020103001	13-16	1/2"-5/8"	188	12,4

6004 Joker XXL self-setting spanner



Application: Hexagon screw heads and bolts with wrench size 24-32 (metric) or 15/16"-1 1/4" (imperial)

Design: Self-setting spanner with ratchet function; size-adjustable mouth side, parallel smooth jaws; with 30° return angle due to the corner-width rectangular prisms in the mouth; hole for hanging

	mm	mm	mm	mm
05020102001	24-32	15/16"-1 1/4"	322	20



Ratchet mechanism for fast work



The ratchet function in the mouth sees to fast and consistent screwdriving without removing the tool.

Low return angle

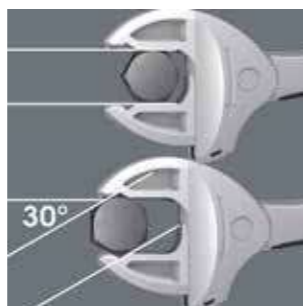

Thanks to the corner-width rectangular prisms, a return angle of only 30° can be realized.

6004 Joker L self-setting spanner



Application: Hexagon screw heads and bolts with wrench size 16-19 (metric) or 5/8"-3/4" (imperial)

Design: Self-setting spanner with ratchet function; size-adjustable mouth side, parallel smooth jaws; with 30° return angle due to the corner-width rectangular prisms in the mouth; hole for hanging

	mm	mm	mm	mm
05020101001	16-19	5/8"-3/4"	224	14



Automatically and continuously self-setting



With its automatically and continuously gripping parallel jaws the Joker spanner 6004 covers all dimensions in the respective field of application. The tool automatically finds the required size when placed on the bolt or screw, no setting required.



Gentle to the screw



The parallel smooth jaws of the Joker 6004 allow surface pressure and can thus prevent rounding of the bolt or screw head, which can occur during power transmission on corners.

Joker 6004

Many users wish to have a universal screwdriving tool with the widest possible range of applications. It should be a single tool for multiple metric and imperial dimensions.

It should automatically adjust to the different screw sizes. It should be safe to grab without damaging anything and allow for a high working speed.

The continuous and parallel jaws replace several single spanner dimensions. The required size is automatically and continuously set when attaching the tool to the hexagon bolt or screw.

The integrated lever mechanism securely clamps the hexagon screw or bolt between the jaws, which significantly reduces the risk of slipping or damage.

The ratchet function ensures fast and consistent screwdriving without removing the tool. Thanks to the corner-width rectangular prisms, a return angle of only 30° can be realized.

The single-arm design in conjunction with the ratchet function and the corner-width prism make it possible to work even in confined spaces. The adjustable Joker 6004 is the universal screwdriving tool.

NEW

6004 Joker 4 set 1 self-setting spanner set



Self-setting spanner set
4-piece set
In robust folding pouch

Part Number	Dimensions
05020110001	6004 Joker XS 1x 7-10 (1/4"-3/8") x117
	6004 Joker S 1x 10-13 (1/16"-1/2") x154
	6004 Joker M 1x 13-16 (1/2"-5/8") x188
	6004 Joker L 1x 16-19 (5/8"-3/4") x224

Joker 6003 combination wrench

Mouth side with only 15° return angle.
When things get tight.



6003 Joker 11 Set 1 combination wrench set



6003 Joker combination wrench



Application: Hexagon screw heads and bolts

Design: Combination wrench; open-end offset by 7,5°, ring side pivoted by 15°; with Take it easy tool finder: colour coding by size

		mm	mm	mm	mm	mm
05020200001		8	115	19	4,5	12,5
05020201001		10	125	22	5	15
05020202001		11	135	24,5	5	17
05020203001		12	148	26	5,5	18
05020204001		13	160	27	6	19
05020205001		14	167	29	6	20
05020206001		15	174	32	6	22
05020207001		16	182	35	6,5	23
05020208001		17	190	38	6,5	24,5
05020209001		18	210	39	7,5	26
05020210001		19	230	42	7,5	27,5

Combination wrench set, open-end offset by 7,5°

11-piece set

In robust pouch

05020231001				
	6003 Joker	1x 8x115; 1x 10x125; 1x 11x135; 1x 12x148; 1x 13x160; 1x 14x167; 1x 15x174; 1x 16x182; 1x 17x190; 1x 18x210; 1x 19x230		
	K240	1x 50,0x240,0		

6003 Joker 5 Set 1 combination wrench set



Combination wrench set, open-end offset by 7,5°

5-piece set

In robust pouch

05020230001		
	6003 Joker	1x 8x115; 1x 10x125; 1x 13x160; 1x 17x190; 1x 19x230
	K120	1x 50,0x70,0

Joker 6003



For very tight spaces



The Joker 6003 combination wrench with its special mouth geometry – a open-end offset by 7.5° and the double hexagon geometry – doubles the placement possibilities when repeatedly turning the wrench 180° around the longitudinal axis. Bolts and screw heads can be accessed every 15°.

The Joker 6003 will automatically find the respective placement point after every turn.

Angled ring side

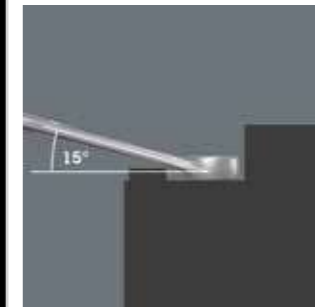

The ring side is angled at 15° to the tool axis to prevent injury.





6003 Joker 8 Imperial Set 1 combination wrench set, Imperial



Combination wrench set, open-end offset by 7,5°
8-piece set
In robust pouch

05020241001		
6003 Joker Imperial	1x 5/16"x115; 1x 3/8"x125; 1x 7/16"x135; 1x 1/2"x160; 1x 9/16"x167; 1x 5/8"x182; 1x 11/16"x210; 1x 3/4"x230	
K240	1x 50,0x240,0	

6003 Joker 5 Imperial Set 1 combination wrench set, Imperial



Combination wrench set, open-end offset by 7,5°
5-piece set
In robust pouch

05020240001		
6003 Joker Imperial	1x 5/16"x115; 1x 3/8"x125; 1x 1/2"x160; 1x 9/16"x167; 1x 3/4"x230	
K120	1x 50,0x70,0	

6003 Joker combination wrench, Imperial

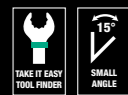

Application: Hexagon screw heads and bolts

Design: Combination wrench; open-end offset by 7,5°, ring side pivoted by 15°; with Take it easy tool finder: colour coding by size

		mm	mm	mm	mm	mm
05020211001		5/16"	115	19	4,5	12,5
05020212001		3/8"	125	22	5	15
05020213001		7/16"	135	24,5	5	17
05020214001		1/2"	160	26	6	19
05020215001		9/16"	167	29	6	20
05020216001		5/8"	182	35	6,5	23
05020217001		11/16"	210	40	7,5	26
05020218001		3/4"	230	42	7,5	27,5

Joker 6002



Joker 6002



Double open-ended wrench



The Joker double open-ended wrench is ideally suited for locking down nuts and bolts.



Holding function



for dropped nuts and bolts! After applying and positioning the nut or bolt, fastening can begin immediately – no additional tools required.

6002 Joker Double open-ended wrenches

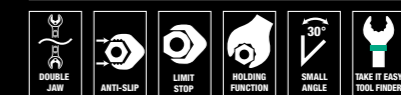

Application: Hexagon bolts and nuts

Design: Double open-ended wrench

		mm	mm	mm	mm	mm
05003760001		10	23	13	27	5,5
05003765001		17	37	19	42	8,5
05020260001		20	48	22	51	10
05020261001		22	48	24	51	10
05020262001		24	51	27	60	11
05020263001		27	63	32	66	12
05020264001		30	63	32	66	12



Kraftform Turbo

Quadruples the screwdriving speed – in a purely mechanical way.

Handle/interchangeable blade system



Thanks to the Rapidaptor bit holder, the Kraftform Turbo can be used with all conventional 1/4" bits.

Kraftform Kompakt Turbo 1

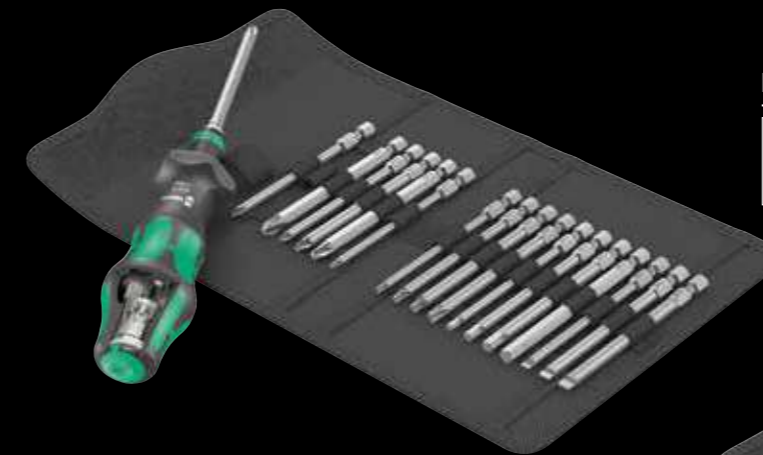

Kraftform Kompakt Turbo Imperial 1

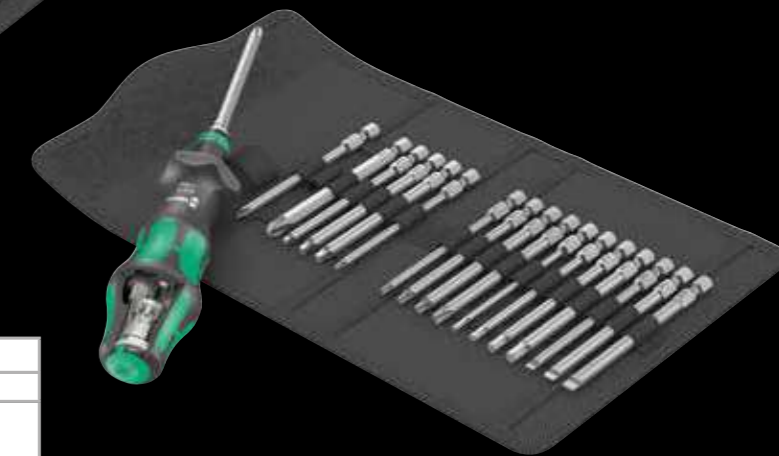

Folding pouch with 89 mm long bits

19-piece set

1 bit-holding Kraftform Turbo with Rapidaptor quick-release chuck

05057482001	
●	826 T Kraftform Turbo 1x 1/4"x146
+	851/4 Z PH 1x PH 1x89; 1x PH 2x89; 1x PH 3x89
+	855/4 Z PZ 1x PZ 1x89; 1x PZ 2x89; 1x PZ 3x89
⊕	867/4 Z TORX® 1x TX 10x89; 1x TX 15x89; 1x TX 20x89; 1x TX 25x89; 1x TX 30x89
○	840/4 Z Hex-Plus 1x 3,0x89; 1x 4,0x89; 1x 5,0x89; 1x 6,0x89
⊖	800/4 Z 1x 0,8x4,0x89; 1x 1,0x5,5x89; 1x 1,2x6,5x89
K120 1x 50,0x70,0	

Folding pouch with 89 mm long bits

19-piece set

1 bit-holding Kraftform Turbo with Rapidaptor quick-release chuck

05057483001	
●	826 T Kraftform Turbo 1x 1/4"x146
+	851/4 Z PH 1x PH 1x89; 1x PH 2x89; 1x PH 3x89
⊕	867/4 Z TORX® 1x TX 10x89; 1x TX 15x89; 1x TX 20x89; 1x TX 25x89; 1x TX 30x89
○	840/4 Z Hex-Plus 1x 3/32"x89; 1x 1/8"x89; 1x 5/32"x89; 1x 3/16"x89
○	868/4 Square-Plus 1x # 1x89; 1x # 2x89; 1x # 3x89
⊖	800/4 Z 1x 0,8x4,0x89; 1x 1,0x5,5x89; 1x 1,2x6,5x89
K120 1x 50,0x70,0	



Faster screwdriving



The construction of the Kraftform Turbo allows a quadruplication of the speed when manually screwdriving, especially with metric threads – purely mechanically, without electricity! The robust steel design is maintenance-free and ensures a long product life.

826 T Kraftform Turbo bits handholder with Rapidaptor quick-release chuck



Application: Suitable for bits with 1/4" - external hexagon drive as per DIN ISO 1173-C 6,3 and E 6,3 and Wera connection series 1 and 4

Design: Connectable mechanic turbo function for quadrupling the screwdriving speed; robust, maintenance-free gear made of steel; 1/4" - hexagon socket mounting with Rapidaptor technology with rapid-in, rapid-out, rapid-spin, chuck-all and single-hand functions, magnetic

Handle: Kraftform with anti-roll protection, multi-component

05057480001	
●	1/4" 146

With and without Turbo



The Turbo function can either be switched on or off by pressing a button. For initial loosening and final tightening (or fine torque adjustment) of screws the Turbo function is disabled. For free running screws the Turbo function is enabled.



Kraftform Turbo i Quadruples the screwdriving speed – in a purely mechanical way.

Kraftform Kompakt Turbo i 1



16-piece set

1 blade holding 817 Kraftform VDE handle and 1 blade holding 827 T i Kraftform Turbo handle; both for Wera VDE interchangeable blades only

14 VDE interchangeable blades (each 154 mm long) with reduced blade diameter (articles KK 60 i 0,4x2,5 and KK 67 i TX 10 standard blade diameter) with integrated protective insulation, so that low-lying screw and spring elements can be reached and operated

05057484001	
●	827 T i Kraftform Turbo 1x 9x125
●	817 VDE 1x 9x102
+	KK 62 iS 1x PH 1x154; 1x PH 2x154
+	KK 65 iS PZ 1x PZ 1x154; 1x PZ 2x154
+	KK 65 iS PZ/S 1x # 1x154; 1x # 2x154
⊗	KK 67 i TORX® 1x TX 10x154
⊗	KK 67 iS TORX® 1x TX 15x154; 1x TX 20x154; 1x TX 25x154
●	KK 60 i 1x 0,4x2,5x154
●	KK 60 iS 1x 0,6x3,5x154; 1x 0,8x4,0x154; 1x 1,0x5,5x154
	K120 1x 50,0x70,0



Individually tested



The individual testing at 10,000 volts, in accordance with IEC 60900, ensures safe working with loads up to 1,000 volts.

Kraftform Kompakt Turbo i Imperial 1



16-piece set

1 blade holding 817 Kraftform VDE handle and 1 blade holding 827 T i Kraftform Turbo handle; both for Wera VDE interchangeable blades only

14 VDE interchangeable blades (each 154 mm long) with reduced blade diameter (articles KK 60 i 0,4x2,5 and KK 67 i TX 10 standard blade diameter) with integrated protective insulation, so that low-lying screw and spring elements can be reached and operated

05057485001	
●	827 T i Kraftform Turbo 1x 9x125
●	817 VDE 1x 9x102
+	KK 62 iS 1x PH 1x154; 1x PH 2x154
+	KK 62 i PH/S 1x # 1x154; 1x # 2x154
⊗	KK 67 i TORX® 1x TX 10x154
⊗	KK 67 iS TORX® 1x TX 15x154; 1x TX 20x154; 1x TX 25x154
○	KK 68 iS 1x # 1x154; 1x # 2x154
●	KK 60 i 1x 0,4x2,5x154
●	KK 60 iS 1x 0,6x3,5x154; 1x 0,8x4,0x154; 1x 1,0x5,5x154
	K120 1x 50,0x70,0

827 T i Kraftform Turbo hand holder



Application: For Wera VDE interchangeable blades only

Design: Connectable mechanic turbo function for quadrupling the screwdriving speed; robust, maintenance-free gear made of steel

Handle: Kraftform with anti-roll protection, multi-component

05057481001	
●	9 125



Faster screwdriving

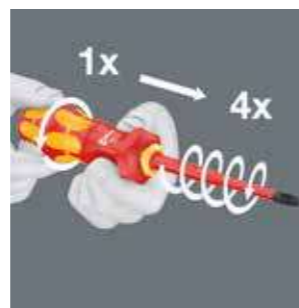

The construction of the Kraftform Turbo allows a quadruplication of the speed when manually screwdriving, especially with metric threads – purely mechanically, without electricity! The robust steel design is maintenance-free and ensures a long product life.

With and without Turbo



The Turbo function can either be switched on or off by pressing a button. For initial loosening and final tightening (or fine torque adjustment) of screws the Turbo function is disabled. For free running screws the Turbo function is enabled.

Kraftform screwdrivers

in compact, textile box with Wera 2go compatibility

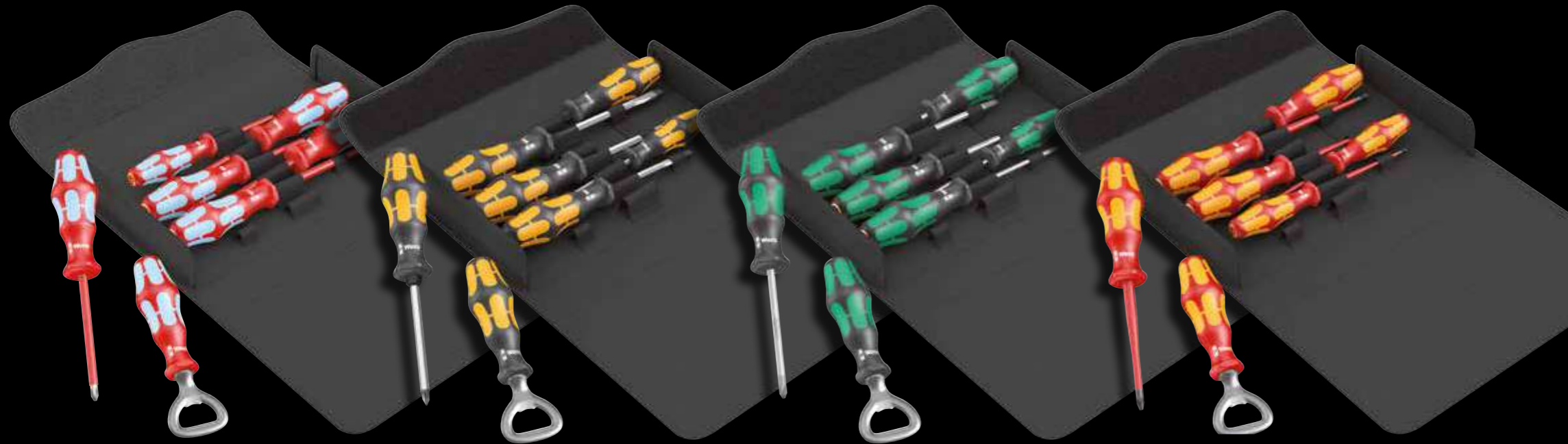

Perfect system supplement

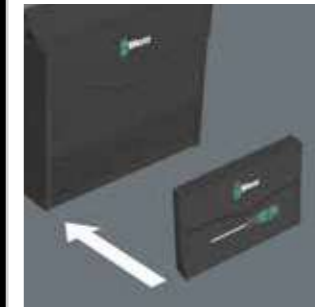

Thanks to its hook and loop fastener zone, the textile box can be docked with the Wera 2go 1 Tool Carrier and with the Wera 2go 2 Tool Container(s).



Integrated impact cap (Kraftform 900)



An integrated impact cap lengthens the service life and reduces the danger of splintering. Nevertheless, always wear protective goggles.

NEW

Kraftform 3100 i/7 set 1 Screwdriver set, stainless



Kraftform stainless: the safety screwdriver for stainless steel screws, Lasertip blade. Take it easy tool finder: colour coding according to profile and size stamp.

Application: Slotted, Phillips and Pozidriv screws

Design: 7-piece set in compact, textile box with Wera2go compatibility. With iconic Wera bottle opener.

05022750001	
+	3162 i VDE 1x PH 2x100
+	3165 i PZ VDE 1x PZ 1x80; 1x PZ 2x100
-	3160 i VDE 1x 0,6x3,5x100; 1x 0,8x4,0x100; 1x 1,0x5,5x125
	bottle opener 1x 147
	K240 1x 50,0x240,0

NEW

Kraftform 900/7 set 1 screwdriver set Kraftform Wera: The chiseldriver

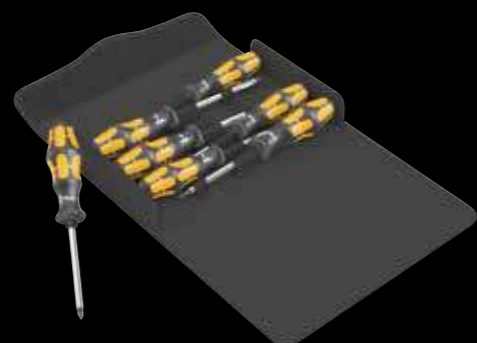

Application: Slotted, Phillips and TORX® screws

Design: 7-piece set in compact, textile box with Wera2go compatibility

05137811001	
+	917 SPH 1x PH 1x80; 1x PH 2x100
+	977 TORX® 1x TX 20x90; 1x TX 25x100
-	932 A 1x 0,8x4,5x90; 1x 1,0x5,5x100; 1x 1,2x7,0x125
	K240 1x 50,0x240,0

NEW

Kraftform 900/7 set 2 screwdriver set Kraftform Wera: The chiseldriver



Application: Slotted and Phillips screws

Design: 7-piece set in compact, textile box with Wera2go compatibility. With iconic Wera bottle opener.

05137812001	
+	917 SPH 1x PH 1x80; 1x PH 2x100
-	932 A 1x 0,6x3,5x80 ¹⁾ ; 1x 0,8x4,5x90; 1x 1,0x5,5x100; 1x 1,2x7,0x125
	bottle opener 1x 145
	K240 1x 50,0x240,0

¹⁾No throughout blade, no impact cap and no hexagon bolster

NEW

Kraftform 900/7 set 3 screwdriver set Kraftform Wera: The chiseldriver



Application: Slotted and Pozidriv screws

Design: 7-piece set in compact, textile box with Wera2go compatibility. With iconic Wera bottle opener.

05137813001	
+	918 SPZ 1x PZ 1x80; 1x PZ 2x100
-	932 A 1x 0,6x3,5x80 ¹⁾ ; 1x 0,8x4,5x90; 1x 1,0x5,5x100; 1x 1,2x7,0x125
	bottle opener 1x 145
	K240 1x 50,0x240,0

¹⁾No throughout blade, no impact cap and no hexagon bolster

NEW

Kraftform 300/7 set 1 screwdriver set Kraftform Plus

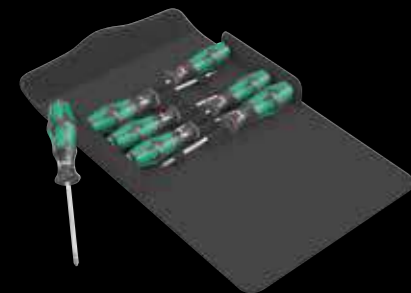

Includes some tools with Lasertip round blades. With Take it easy tool finder: Colour coding by profiles and size stamping.

Application: Slotted, Phillips, Pozidriv and TORX® screws

Design: 7-piece set in compact, textile box with Wera2go compatibility

05105623001		
+	350 PH	1x PH 1x80; 1x PH 2x100
+	355 PZ	1x PZ 2x100
+	367 TORX®	1x TX 15x80; 1x TX 20x100; 1x TX 25x100
-	335	1x 0,8x4,0x100
-	K240	1x 50,0x240,0

NEW

Kraftform 300/7 set 2 screwdriver set Kraftform Plus



Includes some tools with Lasertip round blades. With Take it easy tool finder: Colour coding by profiles and size stamping.

Application: Slotted and Phillips screws

Design: 7-piece set in compact, textile box with Wera2go compatibility. With iconic Wera bottle opener.

05105624001		
+	350 PH	1x PH 1x80; 1x PH 2x100
-	335	1x 0,5x3,0x80 ¹⁾ ; 1x 0,8x4,0x100; 1x 1,0x5,5x125; 1x 1,2x6,0x100
-	bottle opener	1x 145
-	K240	1x 50,0x240,0

¹⁾without Lasertip

NEW

Kraftform 100 iS/7 set 1 screwdriver set Kraftform Plus series 100. Partly with reduced blade diameter

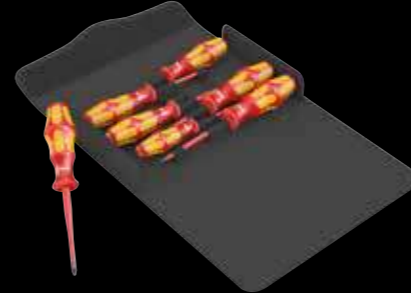

Kraftform: The safety screwdriver. Includes some tools with reduced blade diameter. With tool finder Take it easy: Colour coding by profiles and size stamping.

Application: Slotted, Phillips, combination profile Pozidriv/slotted and TORX® screws

Design: 7-piece set in compact, textile box with Wera2go compatibility

05136013001		
+	162 iS	1x PH 1x80; 1x PH 2x100
+	165 iS PZ/S	1x # 2x100
+	167 i TORX®	1x TX 20x80; 1x TX 25x100
-	VDE	
-	160 iS	1x 0,6x3,5x100; 1x 1,0x5,5x125
-	K240	1x 50,0x240,0

NEW

Kraftform 100 iS/7 set 2 screwdriver set Kraftform Plus series 100. Partly with reduced blade diameter

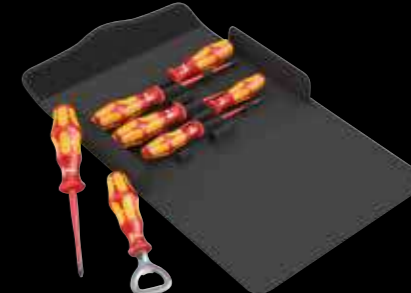

Kraftform: The safety screwdriver. Includes some tools with reduced blade diameter. With tool finder Take it easy: Colour coding by profiles and size stamping.

Application: Slotted and Phillips screws

Design: 7-piece set in compact, textile box with Wera2go compatibility. With iconic Wera bottle opener.

05136022001		
+	162 iS	1x PH 1x80; 1x PH 2x100
-	160 iS	1x 0,6x3,5x100; 1x 0,8x4,0x100; 1x 1,0x5,5x125
-	160 i VDE	1x 0,4x2,5x80 ¹⁾
-	bottle opener	1x 145
-	K240	1x 50,0x240,0

¹⁾without Lasertip

NEW

Kraftform 300/7 set 3 screwdriver set Kraftform Plus

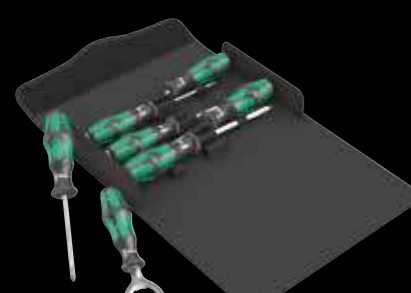

Lasertip blades. Take it easy tool finder: colour coding according to profile and size stamp.

Application: Slotted, Phillips and Pozidriv screws

Design: 7-piece set in compact, textile box with Wera2go compatibility. With iconic Wera bottle opener.

05105625001		
+	350 PH	1x PH 2x100
+	355 PZ	1x PZ 1x80; 1x PZ 2x100
-	334 SK	1x 1,2x6,5x125
-	335	1x 0,8x4,0x100; 1x 1,0x5,5x125
-	bottle opener	1x 145
-	K240	1x 50,0x240,0

NEW

Kraftform 300/7 set 4 screwdriver set Kraftform Plus



Includes some tools with Lasertip round blades. With Take it easy tool finder: Colour coding by profiles and size stamping.

Application: Slotted, Phillips and square socket screws

Design: 7-piece set in compact, textile box with Wera2go compatibility. With iconic Wera bottle opener.

05105626001		
+	350 PH	1x PH 1x80; 1x PH 2x100
-	335	1x 0,8x4,0x100; 1x 1,0x5,5x125
○	368	1x # 1x80; 1x # 2x100
-	bottle opener	1x 145
-	K240	1x 50,0x240,0

NEW

Kraftform 100 iS/7 set 3 screwdriver set Kraftform Plus series 100. Partly with reduced blade diameter



Kraftform: The safety screwdriver. Includes some tools with reduced blade diameter. With tool finder Take it easy: Colour coding by profiles and size stamping.

Application: For slotted, Phillips and square socket screws

Design: 7-piece set in compact, textile box with Wera2go compatibility. With iconic Wera bottle opener.

05136018001		
+	162 iS	1x PH 1x80; 1x PH 2x100
-	160 iS	1x 0,8x4,0x100; 1x 1,0x5,5x125
○	168 i VDE	1x # 1x80; 1x # 2x100
-	bottle opener	1x 145
-	K240	1x 50,0x240,0

NEW

Kraftform 100 i/7 set 1 screwdriver set Kraftform Plus series 100

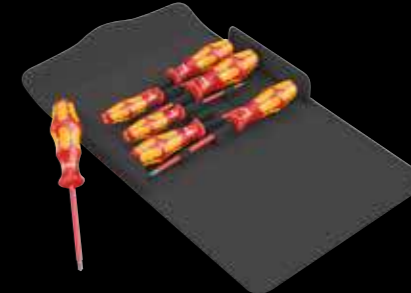

Kraftform: The safety screwdriver. With tool finder Take it easy: Colour coding by profiles and size stamping.

Application: Slotted, Pozidriv and combination profile Phillips/slotted screws

Design: 7-piece set in compact, textile box with Wera2go compatibility

05136019001		
+	165 i PZ VDE	1x PZ 1x80; 1x PZ 2x100
+	162 i PH/S	1x # 2x100
-	VDE	
-	160 i VDE	1x 0,4x2,5x80 ¹⁾ ; 1x 0,6x3,5x100; 1x 0,8x4,0x100; 1x 1,0x5,5x125
-	K240	1x 50,0x240,0

¹⁾without Lasertip

NEW

Click-Torque C 3 set 2 for concrete fixings

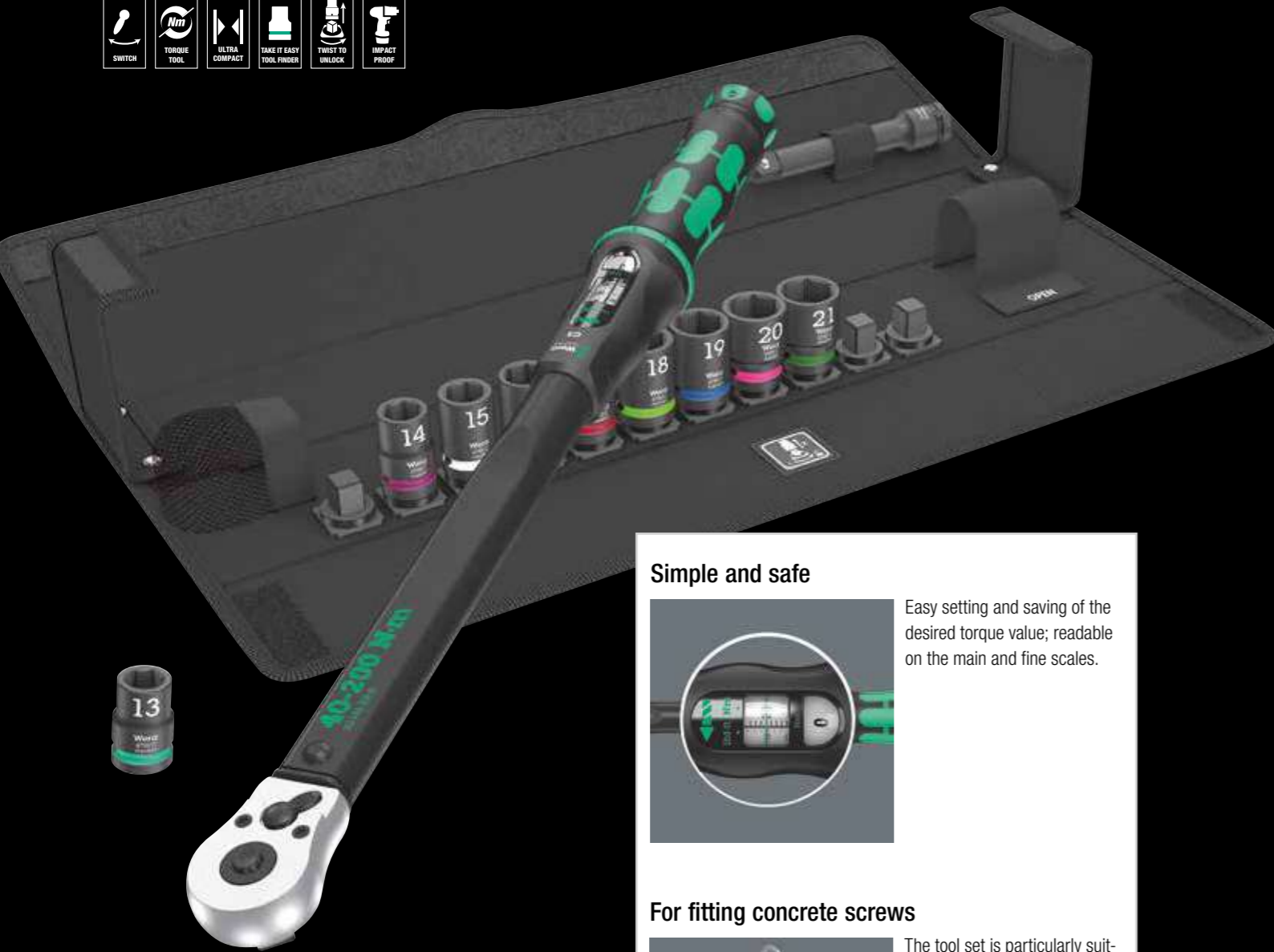

Simple and safe



Easy setting and saving of the desired torque value; readable on the main and fine scales.

For fitting concrete screws



The tool set is particularly suitable for fitting security-relevant cement screws with defined torque moments as per screw manufacturer instructions

Click-Torque Wrench series



Click torque wrench in unmistakable Wera design. Precise to ± 3% as per DIN EN ISO 6789-1:2017-07.

11-piece set; in a surface-preserving, compact and extremely robust textile box. Low volume and weight for simplified mobility.

1 Click-Torque C 3 torque wrench with reversible ratchet with 1/2"-square head-drive, measuring range 40 Nm-200 Nm, accuracy ±3 % of the set value, as per DIN EN ISO 6789-1:2017-07, for clockwise torque control, reversible ratchet, 45 teeth, easy setting and saving of the desired torque value, with audible and tactile locking when the scale values are reached (fine scale only in Newton meters), audible and tactile release mechanism when the set torque value is reached, ergonomic 2-component handle; 9 Impaktor 8790 C socket wrench inserts and 1 short extension 8894 SC for the use with electric and cordless screwdrivers (not with impact wrenches).

05075681001	
Click-Torque C 3	1x 1/2", 40-200 Nm
8790 C Impaktor	1x 13,0x38,0; 1x 14,0x38,0; 1x 15,0x38,0; 1x 16,0x38,0; 1x 17,0x38,0; 1x 18,0x38,0; 1x 19,0x38,0; 1x 20,0x38,0; 1x 21,0x38,0
8894 SC	1x 1/2"x125,0



Smooth plastic sleeve



The rotating plastic sleeve allows for higher control during screwdriving. In addition, the surface of the rim is protected. The plastic sleeves are interchangeable.

Protection for wheel bolts



The internal plastic insert protects the surfaces of the wheel bolts.

Wheel Impaktor C Set 1 Socket set, 1/2" drive



3-piece

3 Wheel Impaktor sockets with 1/2" drive. For use with impact wrenches, with rotating smooth plastic sleeve for higher working speed, better control during screwdriving and additional rim protection. Take it easy tool finder: Colour coding to enable the desired socket to be easily located.

05004595001	
8790 C Wheel Impaktor	1x 17,0x85,0x30,0; 1x 19,0x85,0x30,0; 1x 21,0x85,0x32,0

8790 C Wheel Impaktor Socket with 1/2" drive



Application: Hexagon headed bolts, screws and nuts

Design: For machine operation (impact), retaining pin hole, interchangeable rotating smooth plastic sleeve, plastic insert to protect the wheel-bolt surfaces; chrome-molybdenum, matt black finish. Take it easy tool finder: Colour coding to enable the desired socket to be easily located.

		mm	mm	mm
05004590001	17,0	85,0	30,0	
05004591001	19,0	85,0	30,0	
05004592001	21,0	85,0	32,0	



NEW

393 S Bitholding screwdriver extra slim with flexible shaft



	●	┆	┆	┆
	mm	mm	mm	mm
05028161001	1/4"	173,5	98	6 53/64"

Application: Suitable for 1/4"; DIN ISO 1173-C 6,3 and E 6,3 hexagon insert bits and Wera Series 1 and 4

Design: With a compact stainless steel holder and strong permanent magnet. Secure bit holding feature due to locking mechanism.

Handle: Kraftform with anti-roll protection, multi-component

NEW

Kraftform Kompakt F 1 screwdriving tool set for window installation



35-piece set; in a surface-preserving, compact and extremely robust textile box. Low volume and weight for simplified mobility.

Compact tool set for professional window installation. 1x 393 S extra slim bitholding screwdriver with flexible shaft, with a compact stainless steel holder and strong permanent magnet, secure bit holding feature due to locking mechanism for the application in hard-to-reach installation spaces, 1x 813 bit holder, 14 bits, 1x 1/4" Zyklop Mini 8001 A bit-ratchet, 1x 870/1 adapter (1/4"-hexagon to 1/4"-square head) 1 Zyklop 8794 SA extension, 1/4", short, for socket wrench inserts, 4 Zyklop socket wrench inserts, 2 Hex-Plus L-keys for hexagonal socket screws, 3 Hex-Plus L-keys with holding function for hexagonal socket screws, 6 L-keys with holding function for TORX® screws, 1x 6004 S self-setting spanner for hexagon screw heads and bolts with wrench size 10-13 (metric) or 7/16"-1/2" (imperial).

Symbol	Part Number	Description	Quantity
●	05134013001	393 S	1x 1/4"x173,5
●		813	1x 1/4"x78
●		8001 A	1x 1/4"x87,0
○		870/1	1x 1/4"x25 1)
○		8794 SA	1x 1/4"x75,0
●		8790 HMA	1x 7,0x23,0; 1x 8,0x23,0; 1x 10,0x23,0; 1x 13,0x23,0
+		851/4 TZ PH	1x PH 1x50; 1x PH 2x50; 1x PH 3x50
+		867/4 Z	1x TX 8x50; 1x TX 10x50; 1x TX 15x50; TORX® 1x TX 20x50; 1x TX 25x50; 1x TX 30x50
○		840/4 Z Hex-Plus	1x 2,0x50; 1x 2,5x50; 1x 3,0x50; 1x 4,0x50; 1x 5,0x50
○		950 SPKL Multicolour	1x 2,0x101; 1x 2,5x112
○		950 SPKL HF Multicolour	1x 3,0x123; 1x 4,0x137; 1x 5,0x154
+		967 SXL TORX® HF Multicolour	1x TX 8x90; 1x TX 10x112; 1x TX 15x123; 1x TX 20x137; 1x TX 25x154; 1x TX 30x195
○		6004 Joker S	1x 10-13 (7/16"-1/2") x 154

¹⁾With friction ball; for manual nut spinner sockets



Flexible shaft



"Around the corner screwdriving" with the 393 S screwdriver. The flexible shaft allows to reach fixing screws in unfavourable positions. The ideal tool for screwdriving situations that are difficult to reach.



The Zyklop Mini 1



The Zyklop Mini 1 mini ratchet allows particularly quick screwdriving, even in narrow work situations. With direct bit mounting. With the Wera 870/1 adapter (1/4"-hexagon to 1/4"-square head), 1/4" socket wrenches can also be operated.



L-keys with retaining function for hexagon socket screws



The clamping of the screw is achieved by a flexible locking ball. The holding function is especially helpful in confined, hard-to-reach spaces, where there is no room for a second hand to secure the screw on the tool.



Prevents hand injuries



The outstanding design of the Kraftform handle that fits perfectly into the hand prevents hand injuries such as blisters and calluses.



NEW

889/4/1 F Rapidaptor free-running bit holder for torque screwdrivers with pistol handle



Tip: Suitable for bits with 1/4"- external hexagon drive as per DIN ISO 1173-C 6.3 and E 6.3 and Wera connection series 1 and 4

Design: With free-running feature for particularly quick return movement, without having to remove the screwdriver when tightening screws. Especially suitable for the applications with Wera torque screwdrivers with pistol handle in the 7400 range. Rapidaptor technology with rapid-in, rapid-out, rapid-spin, chuck-all and single-hand functions, with strong permanent magnet

Drive: 1/4"-hexagon, suitable for mounting as per DIN ISO 1173-F 6.3

	mm	mm	mm	mm	mm
05052501001	1/4"	64	2 33/64"	1/4"	16,5

The free-running feature



The free-running feature allows for particularly quick return movement without having to remove the screwdriver when tightening screws.

For tools with pistol handle



Especially for applications with Wera torque screwdrivers with pistol handle for fast and ergonomic working.

NEW

Kraftform Kompakt VDE 7 extra slim 1



1x 817 VDE Kraftform hand holder for Wera VDE interchangeable blades only
 VDE-interchangeable blades (each 154 mm long) with reduced blade diameter with integrated protective insulation, allows sunken screws and spring elements to be accessed and actuated
 7-piece set

05003475001		
	817 VDE	1x 9x102
	KK 62 iS	1x PH 1x154; 1x PH 2x154
	KK 65 iS PZ/S	1x # 2x154
	KK 67 iS TORX®	1x TX 15x154; 1x TX 20x154
	KK 60 iS	1x 0,6x3,5x154
	K70	1x 50,0x70,0



VDE-insulated screwdriver with reduced blade diameter

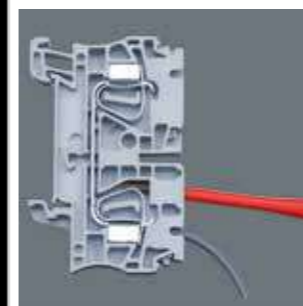

Reduced blade diameter with integrated protective insulation, allows sunken screws and spring elements to be accessed and actuated, individually tested as per IEC 60900.

8008 A Zyklop Mini 3 Ratchet with 1/4" drive



Application: 1/4" square sockets and 1/4" adaptors with square drive, equipped with ball lock

Design: Drop-forged full steel design, fine-tooth ratchet mechanism, small return angle of 6°, forward and reverse drive switch

Handle: Kraftform handle with proven Kraftform geometry provides perfectly designed finger contact zones, ergonomic ratchet head and handle

	mm	mm	mm
05003793001	1/4"	87,0	

165 iS PZ/S # 1 + 2 screwdriver set Kraftform Plus series 100. With reduced blade diameter

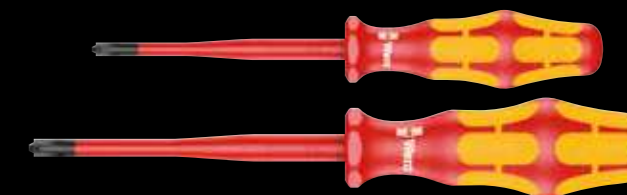

Application: Combination profile Pozidriv/slotted

Design: 2-piece set in a box

05006470001		
	165 iS PZ/S	1x # 1x80; 1x # 2x100

Stainless against extraneous rust



The stainless steel bit 3800/1 (1.8 x 12 x 41mm) is ideal for adjusting the screws that secure the Bridge. Stainless steel prevents the formation of extraneous rust on stainless steel components.

Input-Jacker



The Input-Jacker included in the set allows the output socket to be safely positioned at installation and removal. The external hexagon bolt is loosened or tightened with the Zyklop socket.

Angle wrench to adjust the steel bar in the guitar neck



The special Hex-Plus geometry of the angle wrench makes for a better fit of the tool in the screw, reducing the risk of slippage and damage, and significantly improving the power transmission.

Stringer for guitars



With the 1/4" hexagon, the stringer can be inserted in the Kraftform 815 R handholder included in the set. The ergonomic shape of the handle makes it sit comfortably in the hand; the power can be charged precisely. Fits all guitar machine heads.

9100 Guitar tool set

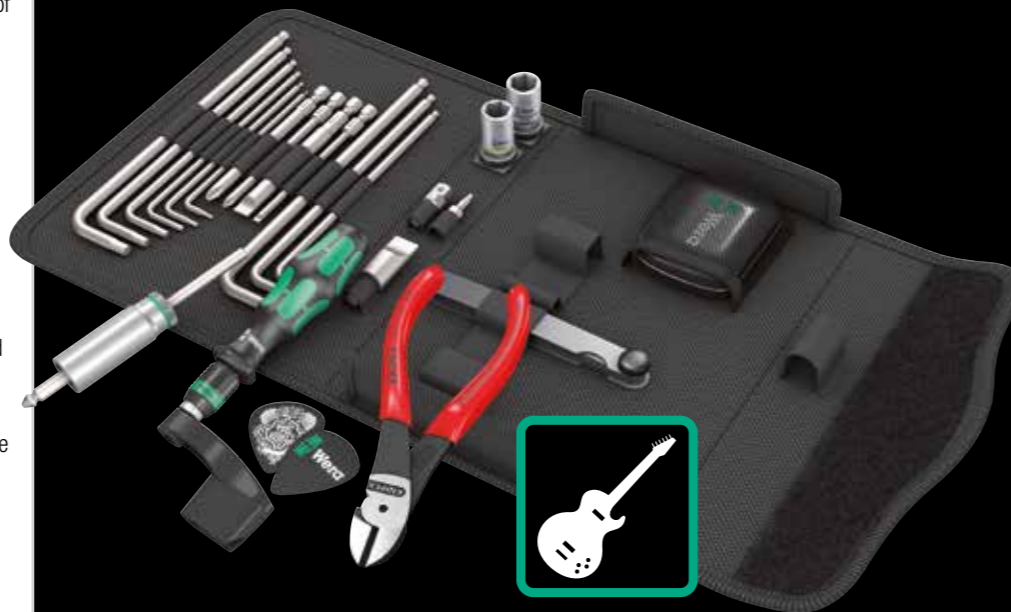

The set contains tools necessary for setting up and maintenance/repair work concerning guitars.

Wera stainless steel L-keys with Hex-Plus profiles (sizes 1.5, 2.0, 2.5, 5.0 and imperial sizes 1/8", 5/32", 3/16"). Wera 89 mm long stainless steel bits for hexagon socket screws (sizes 1.5, 2.0, 2.5), Kraftform handle for 1/4" bits, 1/4" stainless steel bits for slotted screws (sizes 1.8x12x41 mm, 0.6x3.5x89 mm, 1.2x8.0x89 mm), Phillips-head screws (sizes PH 1x89 mm, PH 2x89 mm) and hexagon socket screws (size 0.05"x25 mm), Wera adapter for handle (1/4" hexagon mounting of the handle on 1/4" square head of the sockets), Wera Zyklop sockets (sizes 10, 7/16" and 1/2"), stringer with 1/4" hexagon to be inserted in the handle, Knipex wire-cutting pliers, slip gauge, Input-Jacker, 2 plectrums.

05134015001		
●	815 R	1x 1/4"x119
+	3851/4	1x PH 1x89; 1x PH 2x89
⊖	3800/1 TS	1x 1,8x12,0x41
⊖	3800/4	1x 0,6x3,5x89; 1x 1,2x8,0x89
○	3840/1 TS	1x 0,05"x25
○	3950 PKL	1x 1,5x90; 1x 2,0x101; 1x 2,5x112; 1x 3,0x123; 1x 4,0x137; 1x 5,0x154
○	3950 PKL inch	1x 1/8"x123; 1x 5/32"x137; 1x 3/16"x154
○	870/1	1x 1/4"x25 ¹⁾
●	8790 HMA	1x 10,0x23,0; 1x 7/16"x23,0
●	8790 HMA	1x 1/2"x50,0
	Deep	
	9103	
	9105	
	9104	
	9101	
	9102	
	9110	
	KNIPEX 74 01 140	
	K120	1x 50,0x70,0

¹⁾With friction ball; for manual nut spinner sockets

454/7 HF Set 1 screwdriver set T-handle screwdrivers Hex-Plus with holding function

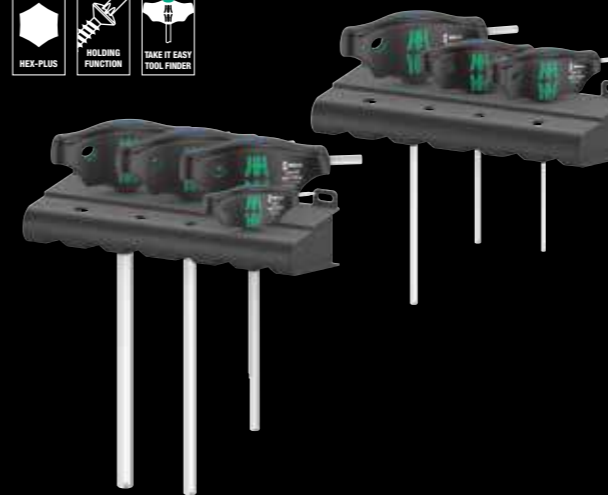
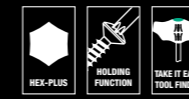

Application: Hexagon socket screws, with holding function on the long arm from size 3

Design: With Take it easy tool finder: colour coding according to profile (blue = hexagon socket) and size stamp. 7-piece set and 2 racks in display carton

05023450001		
○	454	1x 2,5x100
○	454 HF	1x 3x100; 1x 4x100; 1x 5x150; 1x 6x150; 1x 8x200; 1x 10x200
	Rack	2x 190,0x50,0

454/10 HF Set Imperial 1 screwdriver set T-handle screwdrivers Hex-Plus with holding function, imperial

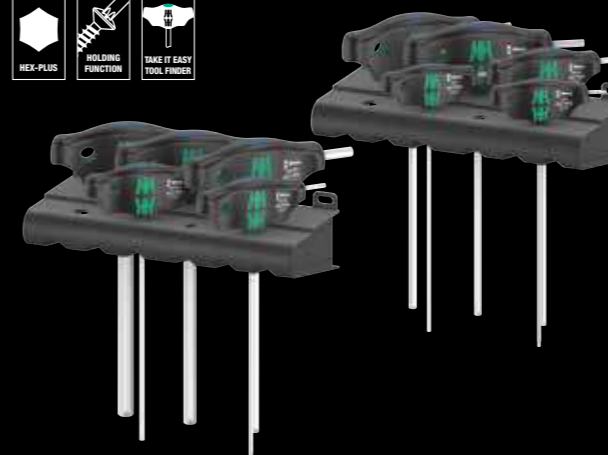

Application: Hexagon socket screws, with holding function on the long arm from size 1/8"

Design: With Take it easy tool finder: colour coding according to profile (blue = hexagon socket) and size stamp. 10-piece set and 2 racks in display carton

05023451001		
○	454 Imperial	1x 3/32"x150; 1x 7/64"x150
○	454 Imperial HF	1x 1/8"x150; 1x 9/64"x150; 1x 5/32"x150; 1x 3/16"x150; 1x 7/32"x150; 1x 1/4"x150; 1x 9/16"x150; 1x 3/8"x150
	Rack	2x 190,0x50,0

Second arm



The additional short arm, which emerges laterally from the handle, allows the transmission of extremely high torques by using the long arm as a lever.

High torque transfer

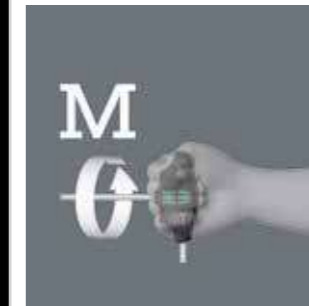

By using the blade as an extension of your lower arm you can transfer particularly high torque.

Corrosion protection and fitting accuracy



Due to the special surface treatment, the blades receive a high level of corrosion protection. The optimum fitting accuracy of the screw is also guaranteed.

"Take it easy" Tool Finder



Screwdrivers with "Take it easy" tool finder: colour coding according to profile and size stamp.

With useful plastic rack

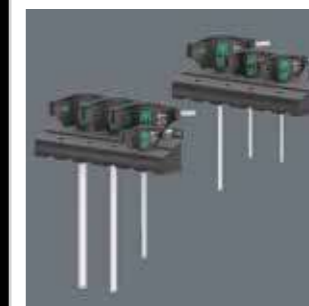

Including useful rack for well-arranged storage of the screwdrivers.

467/7 TORX® HF Set 1 screwdriver set T-handle TORX® screwdrivers with holding function

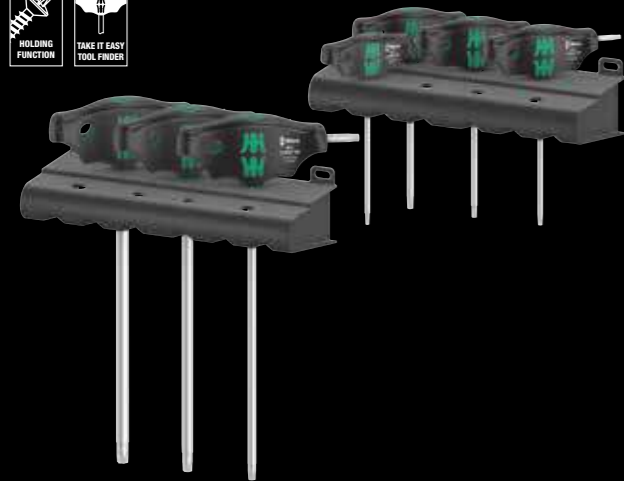

Application: TORX®, with holding function on the long arm for TORX® screws as per specification "Acument Intellectual Properties"

Design: With Take it easy tool finder: colour coding according to profile (green = TORX®) and size stamp. 7-piece set and 2 racks in display carton

05023452001	
467 TORX® HF	1x TX 10x100; 1x TX 15x100; 1x TX 20x100; 1x TX 25x100; 1x TX 30x200; 1x TX 40x200; 1x TX 45x200
Rack	2x 190,0x50,0

Kraftform Kompakt Stubby 1

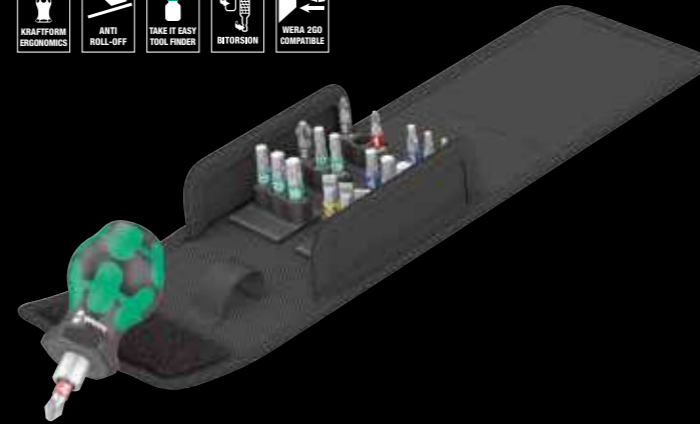

Textile box with 25 mm long bits
19-piece set
1 bit handholder 811/1 Stubby, 18 bits

05057471001	
811/1 Stubby	1x 1/4"
851/1 BTZ PH	1x PH 1x25; 1x PH 2x25
855/1 BTZ PZ	1x PZ 1x25; 1x PZ 2x25
867/1 TORX® BTZ	1x TX 10x25; 1x TX 15x25; 1x TX 20x25; 1x TX 25x25; 1x TX 30x25
840/1 BTZ Hex-Plus	1x 2,0x25; 1x 2,5x25; 1x 3,0x25; 1x 4,0x25; 1x 5,0x25; 1x 5,5x25
800/1 BTZ	1x 0,8x5,5x25; 1x 1,0x5,5x25; 1x 1,2x6,5x25
K70	1x 50,0x70,0

Kraftform Kompakt 400



Folding pouch with 89 mm long bits
17-piece set
1 bit handholder 416 R T-handle with Rapidaptor quick-release chuck

05057470001	
416 R	1x 1/4"x45
851/4 Z PH	1x PH 2x89; 1x PH 3x89
855/4 Z PZ	1x PZ 2x89; 1x PZ 3x89
867/4 Z TORX®	1x TX 10x89; 1x TX 15x89; 1x TX 20x89; 1x TX 25x89; 1x TX 30x89; 1x TX 40x89
840/4 Z Hex-Plus	1x 3,0x89; 1x 4,0x89; 1x 5,0x89; 1x 6,0x89; 1x 8,0x89
800/4 Z	1x 1,0x5,5x89
K120	1x 50,0x70,0

Kraftform Kompakt Stubby ESD 1



Textile box with 25 mm long bits
10-piece set
1 bit handholder 811/1 ESD Stubby, 9 bits

05057472001	
811/1 Stubby ESD	1x 1/4"x54
851/1 Z PH	1x PH 0x25; 1x PH 1x25; 1x PH 2x25
851/1 J	1x PH 00x25x2,0
800/1 Z	1x 0,5x3,0x25; 1x 0,6x4,5x25; 1x 1,0x5,5x25; 1x 1,2x6,5x25; 1x 1,2x8,0x25

Stubby Set 1 screwdriver set



With Take it easy tool finder: colour coding according to profile and size stamp.

Application: Slotted and Phillips screws

Design: 5-piece set in display carton

05008870001	
350 PH Stubby	1x PH 1x25; 1x PH 2x25
335 Stubby	1x 0,6x3,5x24,5; 1x 0,8x4,0x24,5; 1x 1,0x5,5x24,5

Stubby Set 2 screwdriver set



With Take it easy tool finder: colour coding according to profile and size stamp.

Application: Slotted and Pozidriv screws

Design: 5-piece set in display carton

05008871001	
355 PZ Stubby	1x PZ 1x25; 1x PZ 2x25
335 Stubby	1x 0,6x3,5x24,5; 1x 0,8x4,0x24,5; 1x 1,0x5,5x24,5

Stubby Set 3 screwdriver set



With Take it easy tool finder: colour coding according to profile and size stamp.

Application: Slotted, Phillips and square socket screws

Design: 5-piece set in display carton

05008872001	
350 PH Stubby	1x PH 1x25; 1x PH 2x25
335 Stubby	1x 1,0x5,5x24,5
368 Stubby	1x # 01x25; 1x # 02x25

Stubby Set TX 1 screwdriver set TORX®



With Take it easy tool finder: colour coding according to profile and size stamp.

Application: TORX® screws

Design: 5-piece set in display carton

05008876001	
367 TORX® Stubby	1x TX 10x25; 1x TX 15x25; 1x TX 20x25; 1x TX 25x25; 1x TX 27x25

300/7 Mix 1 screwdriver set

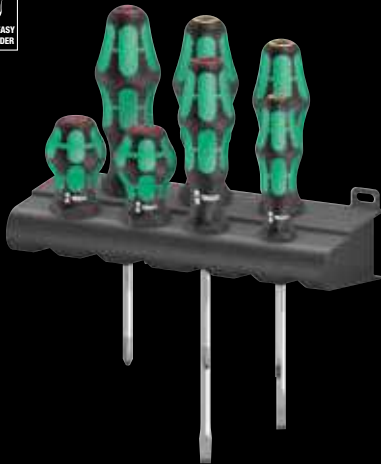

With Take it easy tool finder: colour coding according to profile and size stamp. 5 Lasertip screwdrivers with long blade, 2 Stubby screwdrivers with short blade

Application: Slotted and Phillips screws

Design: 7-piece set and rack in display carton

05008900001	
+	350 PH Stubby 1x PH 1x25; 1x PH 2x25
+	350 PH 1x PH 1x80; 1x PH 2x100
-	334 1x 1,2x6,5x150
-	335 1x 0,5x3,0x80 ¹⁾ ; 1x 1,0x5,5x125
	Rack 1x 190,0x50,0

¹⁾without Lasertip

300/7 Mix 2 screwdriver set

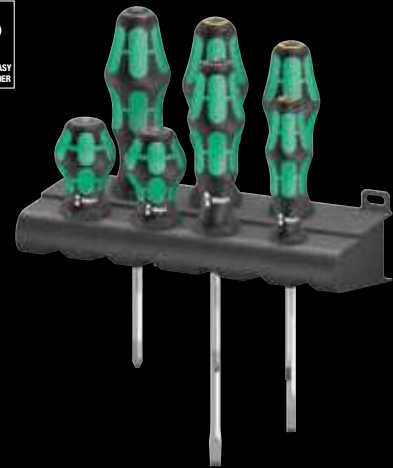

With Take it easy tool finder: colour coding according to profile and size stamp. 5 Lasertip screwdrivers with long blade, 2 Stubby screwdrivers with short blade

Application: Slotted and Pozidriv screws

Design: 7-piece set and rack in display carton

05008901001	
	Rack 1x 190,0x50,0
+	355 PZ Stubby 1x PZ 1x25; 1x PZ 2x25
+	355 PZ 1x PZ 1x80; 1x PZ 2x200
-	334 1x 1,2x6,5x150
-	335 1x 0,5x3,0x80 ¹⁾ ; 1x 1,0x5,5x125

¹⁾without Lasertip

No liability for printing errors or mistakes shall be assumed.



Wera Tools (UK) LTD.
Railway View
Clay Cross
Chesterfield
Derbyshire, S45 9FR

Phone: +44 (0)1246 / 277756
Fax: +44 (0)1246 / 273335
eMail: queries@wera-tools.co.uk
Internet: www.wera-tools.co.uk

Wera Tools Inc. (NA)
4129 Harvester Rd, Unit H
Burlington, Ontario
Canada, L7L 5M3

Phone: 1-800-267-55 41
eMail: info@weratools.com
www.weratools.com

Wera Tools Japan G.K

Phone: +81 7048131142
eMail: frank.yang@wera.de

Wera Werkzeuge GmbH
Korzerter Straße 21–25
D-42349 Wuppertal

Phone: +49 (0)202/40 45-0
Fax: +49 (0)202/40 45 276
E-Mail: info@wera.de
www.wera.de

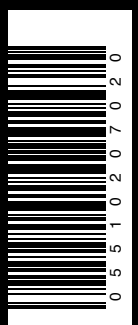

UK 05 510207 020 - 0053701 - 01