

Joker.

The cards have been reshuffled.





We believe that the process of inventing a tool is never completed, so we took another close look at our spanners.

The result is a Joker range with even more problem solvers for the increased requirements in modern screwdriving applications.



Joker 6004



Joker 6003

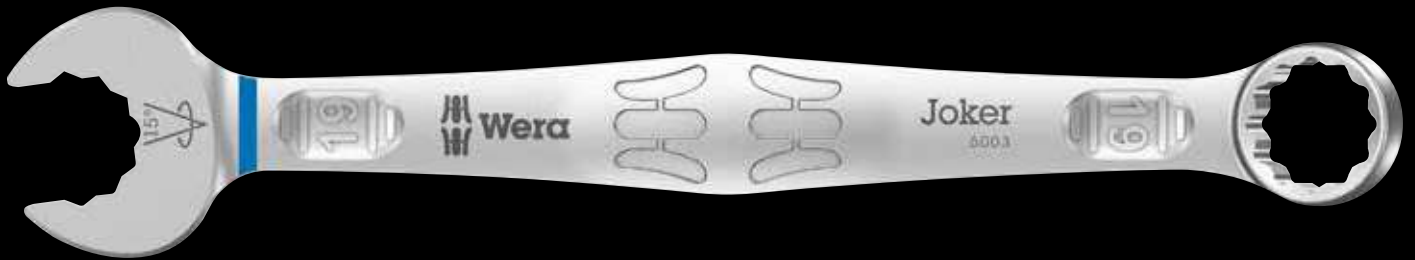

Joker 6002

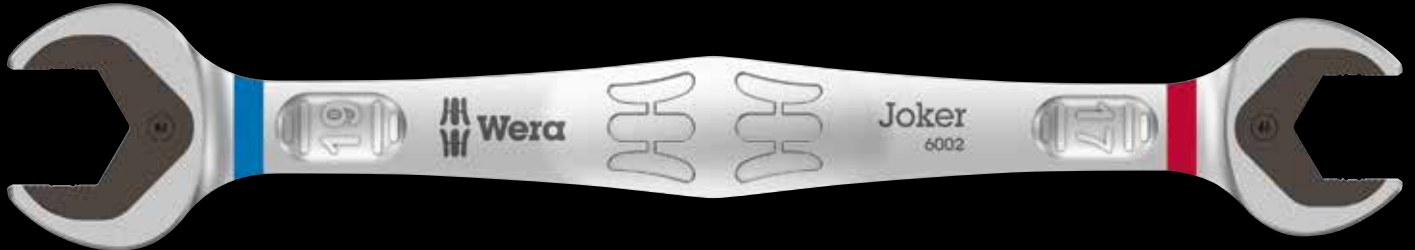

Joker 6001

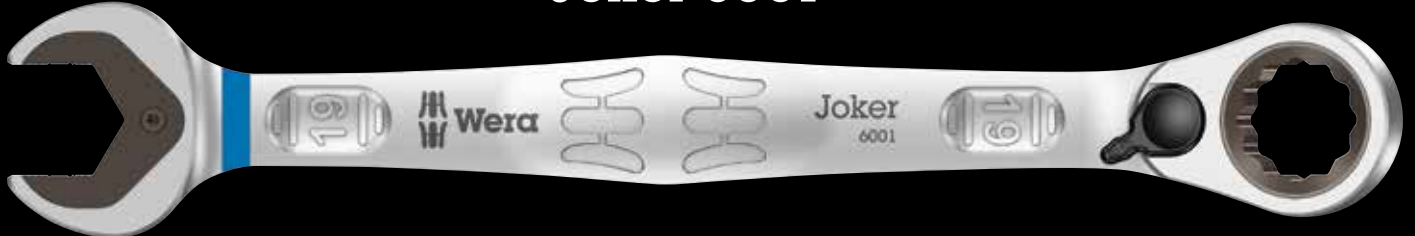

Joker 6000

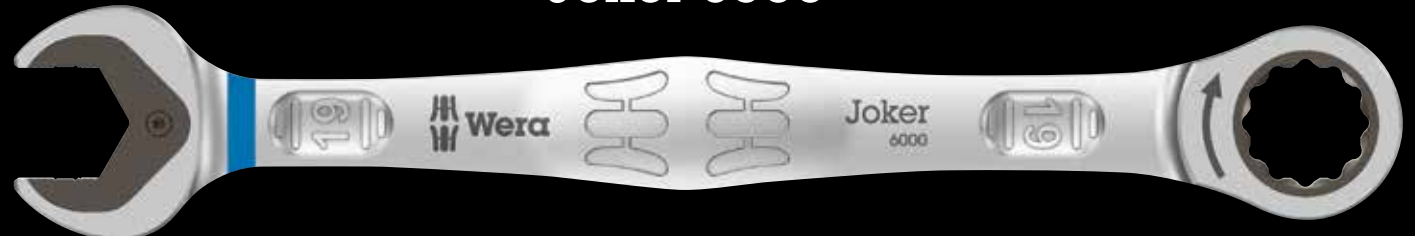

Joker 6004

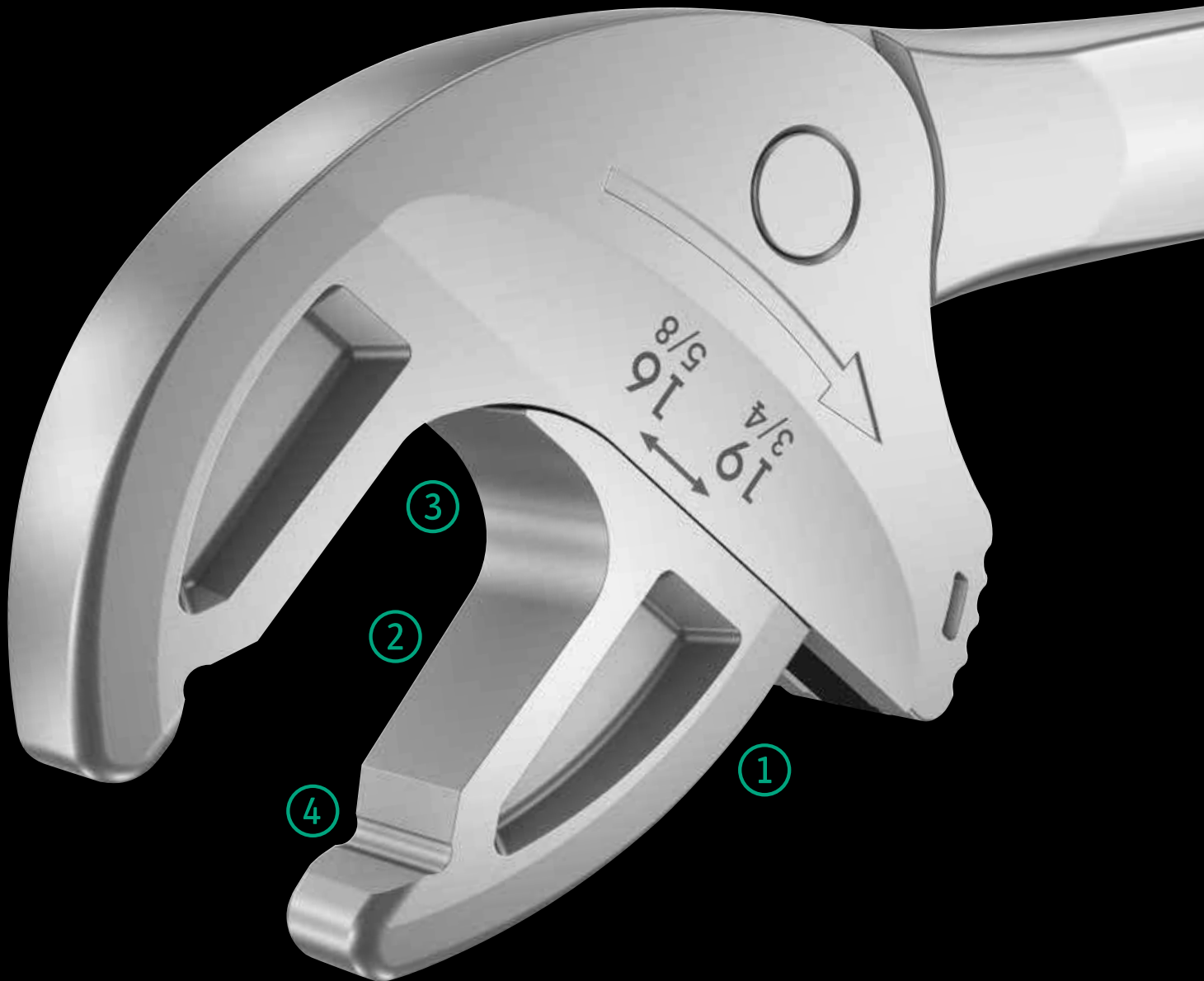

Many users wish to have a universal screwdriving tool with the widest possible range of applications. It should be a single tool for multiple metric and imperial dimensions.

It should automatically adjust to the different screw sizes. It should be safe to grab without damaging anything and allow for a high working speed.

The Joker 6004 fulfills these wishes. The continuous and parallel jaws replace several single spanner dimensions. The required size is automatically and continuously set when attaching the tool to the hexagon bolt or screw.

The integrated lever mechanism securely clamps the hexagon screw or bolt between the jaws, which significantly reduces the risk of slipping or damage.

The ratchet function ensures fast and consistent screwdriving without removing the tool. Thanks to the corner-width rectangular prisms, a back-pivoting angle of only 30° can be realized.

The single-arm design in conjunction with the ratchet function and the corner-width prism make it possible to work even in confined spaces. The adjustable Joker 6004 is the universal screwdriving tool.



Joker 6004

① Automatically and continuously self-setting



With its automatically and continuously gripping parallel jaws the Joker spanner 6004 covers all dimensions in the respective field of application. The tool automatically finds the required size when placed on the bolt or screw, no setting required.

③ Ratchet mechanism for fast work



The ratchet function in the mouth sees to fast and consistent screwdriving without removing the tool.

② Gentle to the screw

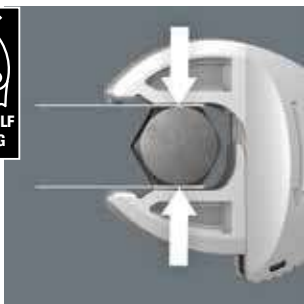

The parallel smooth jaws of the Joker 6004 allow surface pressure and can thus prevent rounding of the bolt or screw head, which can occur during power transmission on corners.

④ Low back-pivoting angle

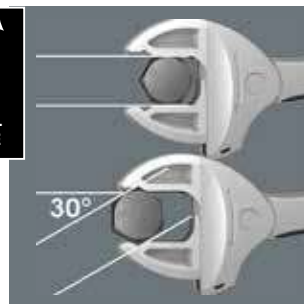

Thanks to the corner-width rectangular prisms, a back-pivoting angle of only 30° can be realized.

Joker 6004 – assortment

6004 Joker XS self-setting spanner



Application: hexagon screw heads and bolts with wrench size 7-10 (metric) or 3/8"-9/32" (imperial)

Design: self-setting spanner with ratchet function; size-adjustable mouth side, parallel smooth jaws; with 30° back-pivoting angle due to the corner-width rectangular prisms in the mouth; hole for hanging

	mm		mm	mm
05020099001 ¹⁾	7-10	3/8"-9/32"	115	7.7

¹⁾ Available from autumn 2020

6004 Joker S self-setting spanner



Application: hexagon screw heads and bolts with wrench size 10-13 (metric) or 7/16"-1/2" (imperial)

Design: self-setting spanner with ratchet function; size-adjustable mouth side, parallel smooth jaws; with 30° back-pivoting angle due to the corner-width rectangular prisms in the mouth; hole for hanging

	mm		mm	mm
05020100001	10-13	7/16"-1/2"	154	10

6004 Joker L self-setting spanner



Application: hexagon screw heads and bolts with wrench size 16-19 (metric) or 5/8"-3/4" (imperial)

Design: self-setting spanner with ratchet function; size-adjustable mouth side, parallel smooth jaws; with 30° back-pivoting angle due to the corner-width rectangular prisms in the mouth; hole for hanging

	mm		mm	mm
05020101001	16-19	5/8"-3/4"	224	14

6004 Joker XXL self-setting spanner



Application: hexagon screw heads and bolts with wrench size 24-32 (metric) or 15/16"-1 1/4" (imperial)

Design: self-setting spanner with ratchet function; size-adjustable mouth side, parallel smooth jaws; with 30° back-pivoting angle due to the corner-width rectangular prisms in the mouth; hole for hanging





	mm		mm	mm
05020102001	24-32	15/16"-1 1/4"	322	20

6004 Joker M self-setting spanner



Application: hexagon screw heads and bolts with wrench size 13-16 (metric) or $1/2''$ - $5/8''$ (imperial)

Design: self-setting spanner with ratchet function; size-adjustable mouth side, parallel smooth jaws; with 30° back-pivoting angle due to the corner-width rectangular prisms in the mouth; hole for hanging

				
	mm		mm	mm
05020103001 ¹⁾	13-16	$1/2''$ - $5/8''$	188	12.4

¹⁾ Available from autumn 2020



Joker 6003

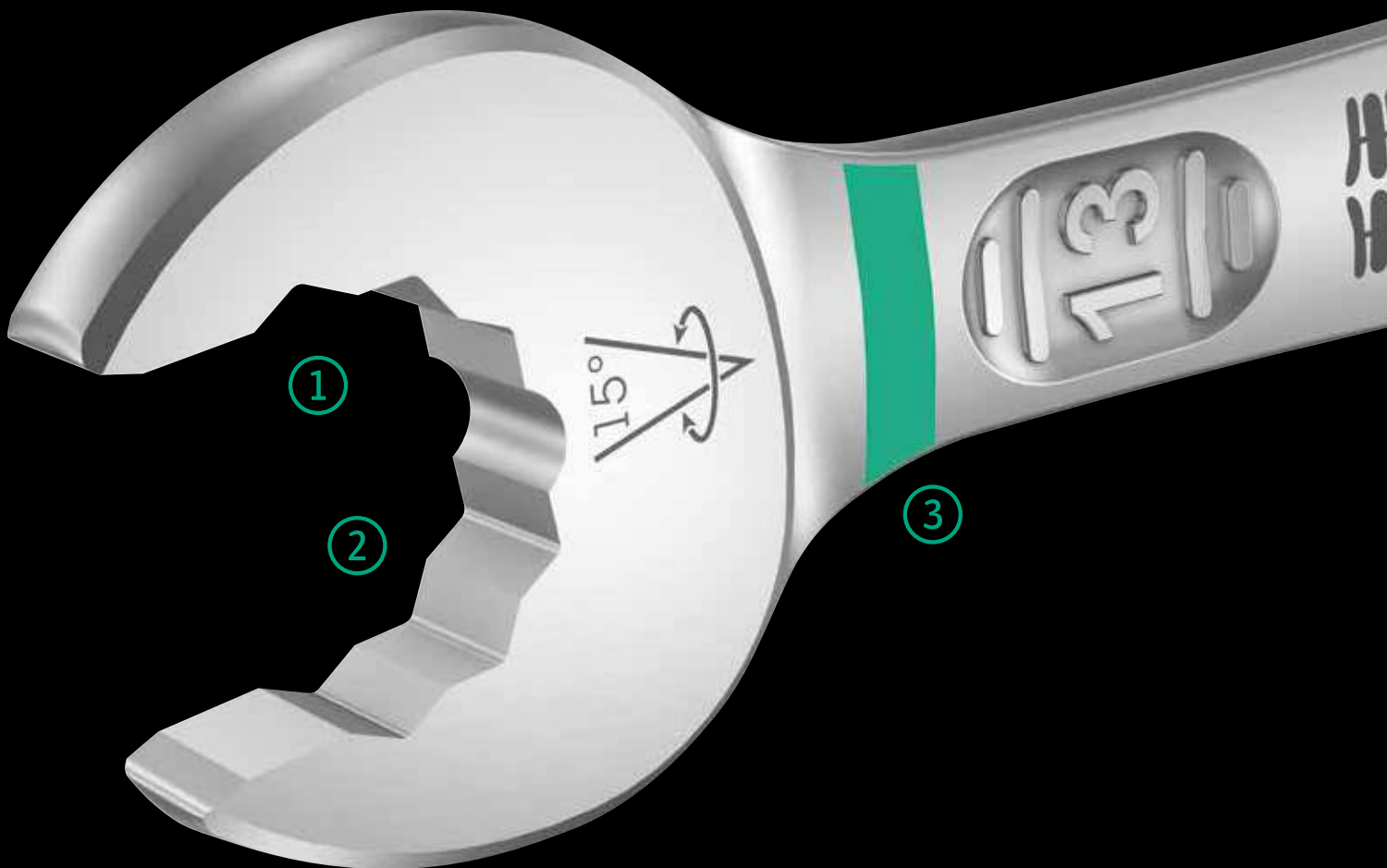

As the installation space becomes increasingly tight during screwdriving, it remains necessary that tools evolve to enable users to work successfully. Narrow spaces require additional placement points of the tool. Can spanners be modified so that the placement possibilities of the tool increase?

The combination of the 7.5° pivoted mouth and the double hexagon geometry doubles the placement points. A repeated 180° turn of the wrench around the longitudinal axis during screwdriving provides four placement possibilities, and bolts or screw heads can be “taken” every 15°.

The Joker 6003 with its smart mouth geometry significantly expands the range of uses in confined spaces. The Joker 6003 will automatically find the respective placement point after every turn.

The slim yet robust ring side is angled by 15° to the tool axis. The high-quality surface treatment achieves a high and long-lasting corrosion protection.

With Take it easy tool finder: colour coding by size.



1 For very tight spaces



The Joker 6003 ring spanner with its special mouth geometry - a mouth side pivoted by 7.5° and the double hexagon geometry - doubles the placement possibilities when repeatedly turning the wrench 180° around the longitudinal axis. Bolts and screw heads can be "taken" every 15°. The

Joker 6003 will automatically find the respective placement point after every turn.

3 "Take it easy" tool finder

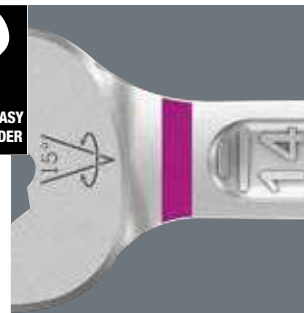

"Take it easy" tool finder system - with profile and size colour-coding for quick and easy tool selection. Colour-coded system for hexagon drive screws (L-Keys, Zyklop bit sockets), external hex drive screws and nuts (Joker wrenches, Zyklop sockets and Zyklop bit sockets with holding function), and TORX® drive screws (L-Keys, Zyklop bit sockets).

2 For pivoting angles under 30°



Thanks to the mouth side pivoted by 7.5°, double hexagon geometry and an adjusted application method (placement - screwdriving - turning - replacement - screwdriving - turning, etc), even screwdriving challenges allowing a pivoting angle of less than 30° can be solved.

4 Angled ring side

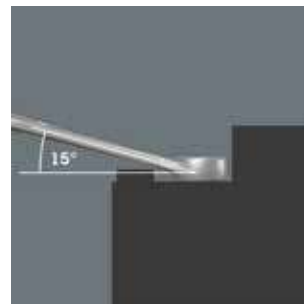

The ring side is angled at 15° to the tool axis to prevent injury.

Joker 6003 – assortment

6003 Joker ring spanner

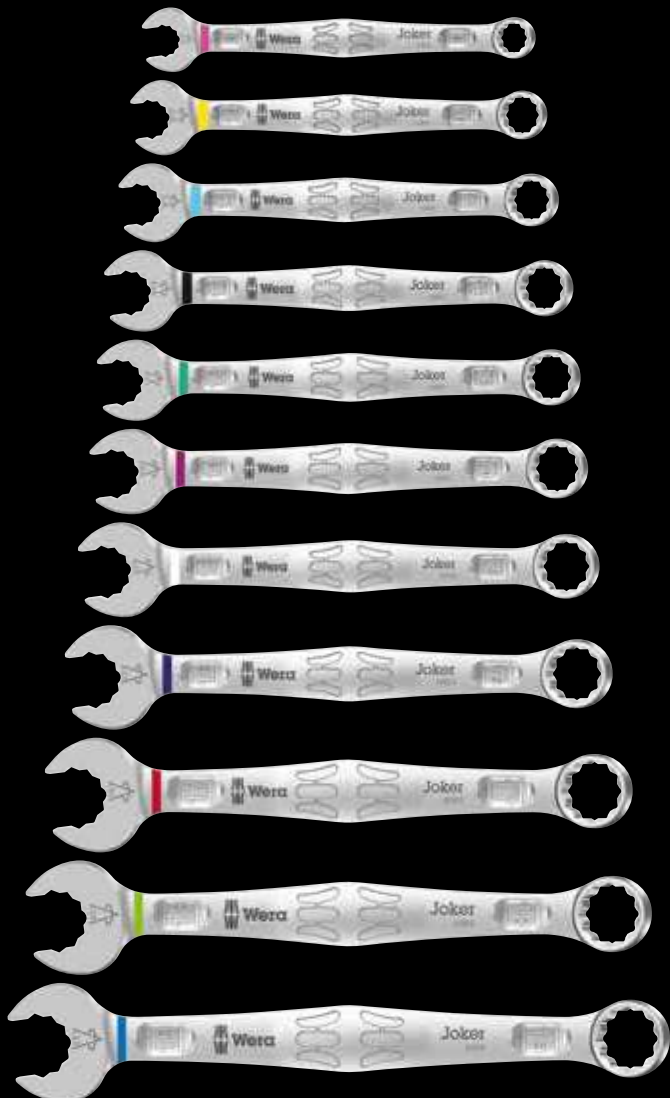

Application: hexagon screw heads and bolts

Design: ring spanner; mouth side pivoted by 7,5°, ring side pivoted by 15°; With Take it easy tool finder: Colour coding by size

		mm	mm	mm	mm	mm
05020200001		8	115	19	4,5	12,5
05020201001		10	125	22	5	15
05020202001		11	135	24,5	5	17
05020203001		12	148	26	5,5	18
05020204001		13	160	27	6	19
05020205001		14	167	29	6	20
05020206001		15	174	32	6	22
05020207001		16	182	35	6,5	23
05020208001		17	190	38	6,5	24,5
05020209001		18	210	39	7,5	26
05020210001		19	230	42	7,5	27,5

6003 Joker 5 Set 1 ring spanner set



Ring spanner set, mouth side pivoted by 7,5°

5-piece set

In robust pouch

05020230001	6003 Joker	1x 8x115; 1x 10x125; 1x 13x160; 1x 17x190; 1x 19x230

6003 Joker 11 Set 1 ring spanner set



Ring spanner set, mouth side pivoted by 7,5°

11-piece set

In robust pouch

05020231001	6003 Joker	1x 8x115; 1x 10x125; 1x 11x135; 1x 12x148; 1x 13x160; 1x 14x167; 1x 15x174; 1x 16x182; 1x 17x190; 1x 18x210; 1x 19x230

6003 Joker ring spanner, Imperial

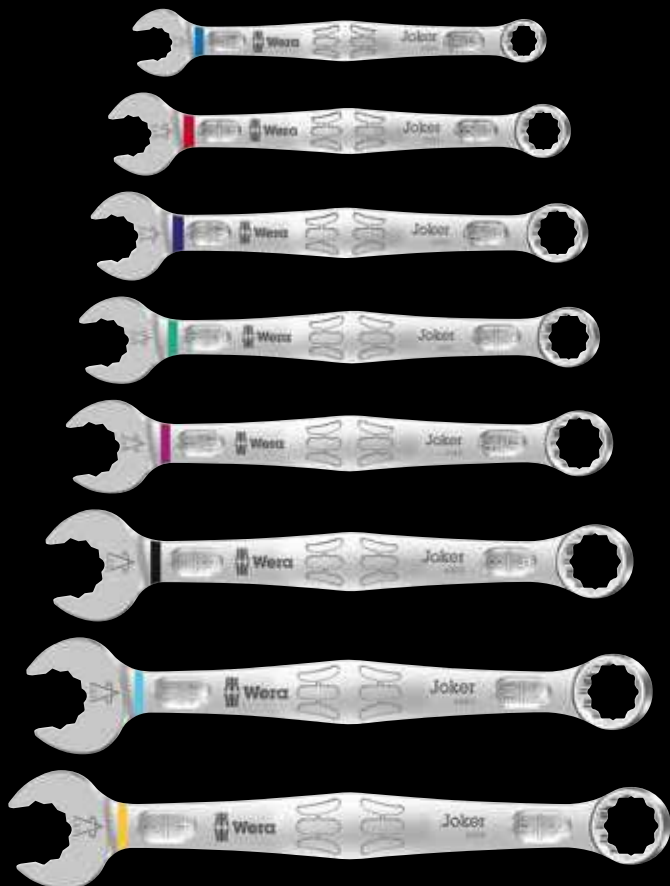
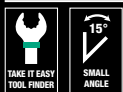

Application: hexagon screw heads and bolts

Design: ring spanner; mouth side pivoted by 7,5°, ring side pivoted by 15°; With Take it easy tool finder: Colour coding by size

		mm	mm	mm	mm	
05020211001		5/16"	115	19	4,5	12,5
05020212001		3/8"	125	22	5	15
05020213001		7/16"	135	24,5	5	17
05020214001		1/2"	160	26	6	19
05020215001		9/16"	167	29	6	20
05020216001		5/8"	182	35	6,5	23
05020217001		11/16"	210	40	7,5	26
05020218001		3/4"	230	42	7,5	27,5

6003 Joker 5 Imperial Set 1 ring spanner set, Imperial



Ring spanner set, mouth side pivoted by 7,5°

5-piece set

In robust pouch

05020240001		
6003 Joker Imperial	1x 5/16"x115; 1x 3/8"x125; 1x 1/2"x160; 1x 9/16"x167; 1x 3/4"x230	

6003 Joker 8 Imperial Set 1 ring spanner set, Imperial



Ring spanner set, mouth side pivoted by 7,5°

8-piece set

In robust pouch

05020241001		
6003 Joker Imperial	1x 5/16"x115; 1x 3/8"x125; 1x 7/16"x135; 1x 1/2"x160; 1x 9/16"x167; 1x 5/8"x182; 1x 11/16"x210; 1x 3/4"x230	

Joker 6002

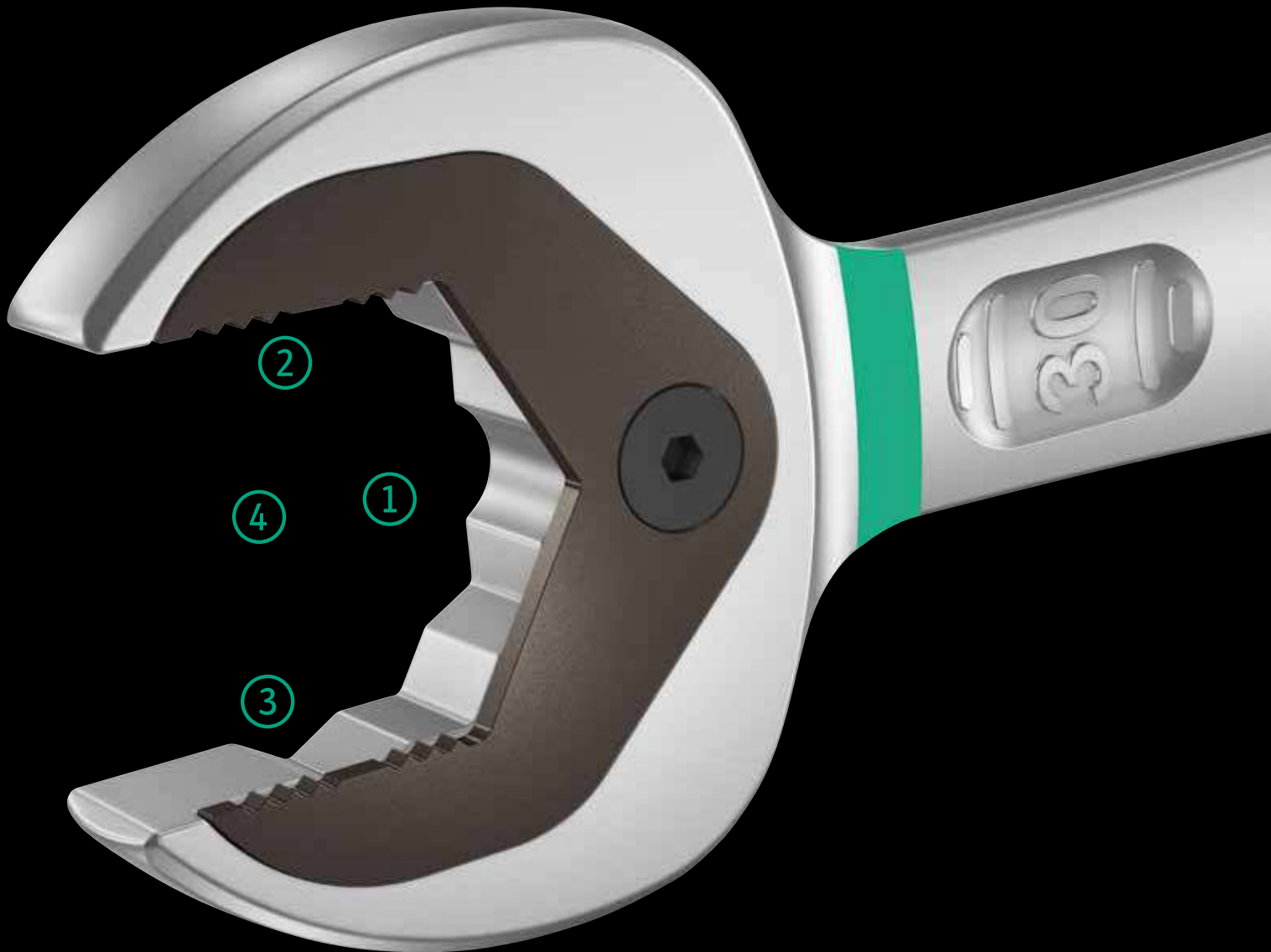

High quality, metric double open-end wrench: It has a holding function, thanks to the metal plate in the jaw, which reduces the risk of dropping nuts and bolts.

The replaceable metal plate in the jaw secures nuts and bolts with its extra hard teeth and reduces the danger of slipping. The integrated limit stop prevents any slipping downwards around the bolt head and allows higher torque to be applied. The double-hex geometry makes

for a positive connection with nuts or bolts and reduces the risk of slipping. A return angle of only 30° prevents any time consuming flipping of the wrench during fastening jobs. The specially forged geometry ensures high torque transfer and great strength.

The Joker double open-ended wrench is ideally suited for locking down nuts and bolts. "Take it easy" Tool Finder with colour coding according to sizes.

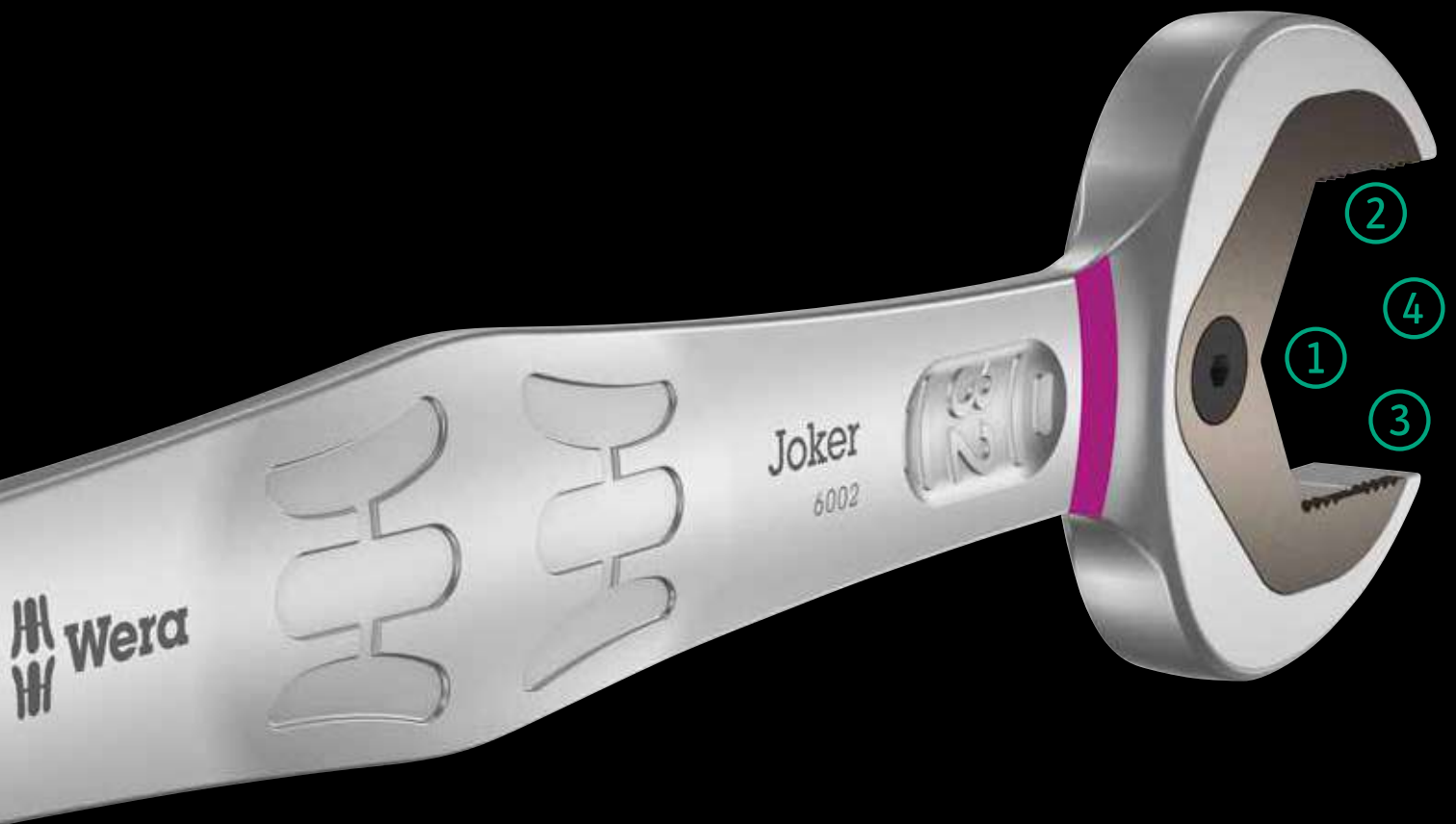

1 Holding function



The Joker's holding function means that nuts and bolts can be held in the jaw and easily positioned where they are needed. Fastening on to the thread can then be done quickly and safely, thanks to the innovative special stop-plate which holds the fastener. No more time-wasting searches

for dropped nuts and bolts! After applying and positioning the nut or bolt, fastening can begin immediately – no additional tools required.

3 Double-hex geometry



The Joker's clever double-hex geometry delivers a very positive connection with nuts or bolts – it's a perfect fit. And the exchangeable, hardened metal gripping plate in the Joker's mouth literally bites itself into the bolt, with its extremely hard tips. Both features combine to prevent slipping, even at higher torque.

2 Integrated limit-stop



Constant re-positioning of the wrench? Difficulty holding fasteners in confined spaces? Easing off to avoid any risks of injury or fastener damage? That was yesterday. Today, the Joker prevents slipping off of the fastener head with its integrated limit-stop – no longer is the thumb needed to act as a

depth stop. This makes applications much easier and allows significantly more force to be applied during fastening jobs.

4 Small return angle



Instead of 60°, the Joker only has a 30° return angle thanks to its unique double-hex design. Along with the Joker's straight neck, this means that flipping the wrench has become a thing of the past. With the Joker, you can now loosen and tighten nuts and bolts,

in situations where conventional tools fail. Particularly in confined spaces, where conventional open-jawed wrenches cannot be used. The combination of limit stop and small return angle enables effective work, even on screw pipe connections.

Joker 6002 – assortment

6002 Joker Double open-ended wrenches



6000/6002 Joker 6 Set 1 Set of ratcheting combination / double open-ended wrenches



Ratcheting Combination/Double Open-Ended Wrench Set
6-piece set
Durable pouch

05020022001	
6000 Joker	1 x 10x159; 1 x 13x177; 1 x 17x224; 1 x 19x246
6002 Joker Double	1 x 10x13x167; 1 x 17x19x235

Application: Hexagon bolts and nuts

Design: Double open-ended wrench

	mm	mm	mm	mm	mm	
05003760001		10	23	13	27	5,5
05003765001		17	37	19	42	8,5
05020260001 ¹⁾		20	48	22	51	10
05020261001 ¹⁾		22	48	24	51	10
05020262001 ¹⁾		24	51	27	60	11
05020263001 ¹⁾		27	63	32	66	12
05020264001 ¹⁾		30	63	32	66	12

¹⁾ Available from May 2020



Joker 6001

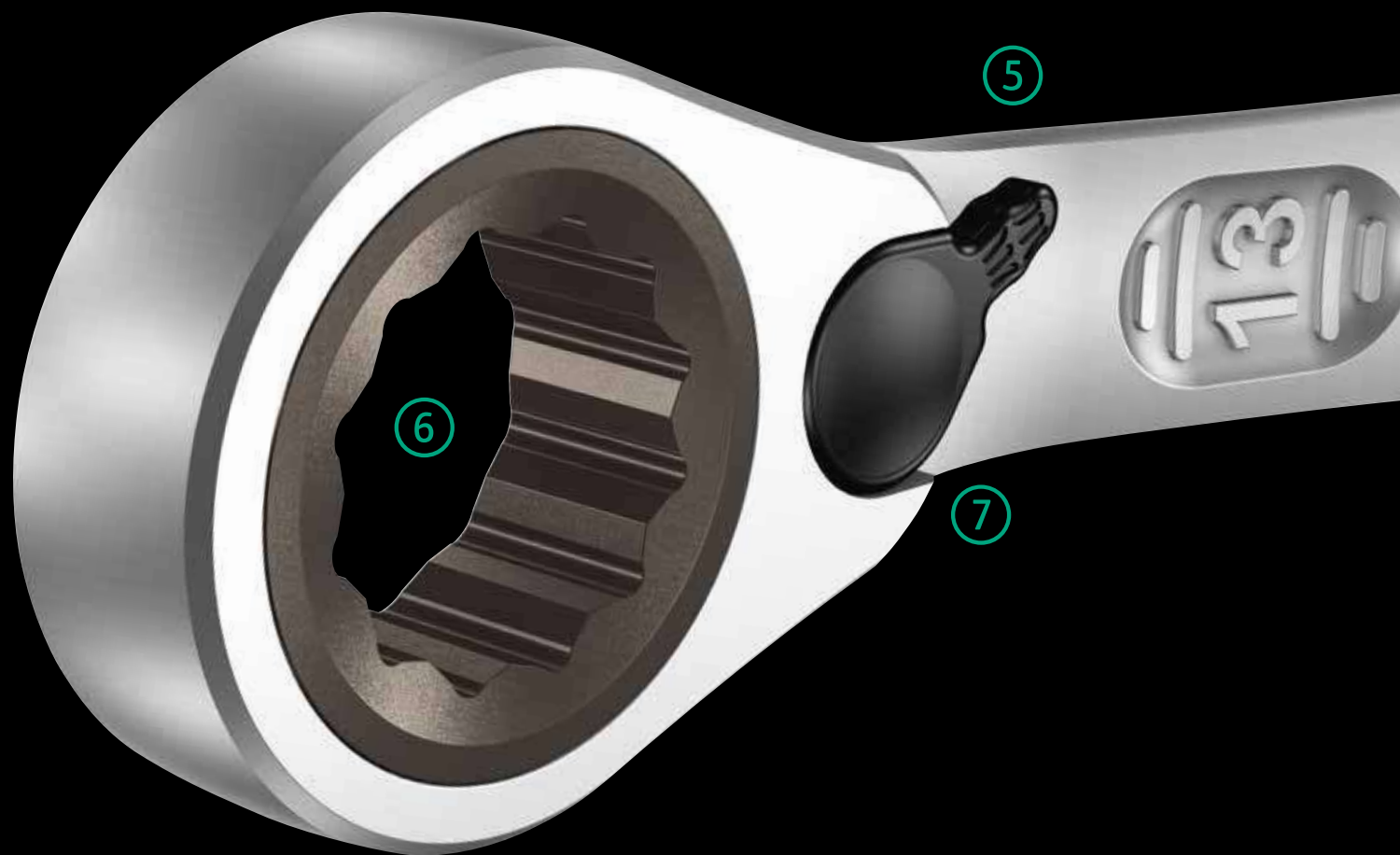

1 Holding function



The Joker's holding function means that nuts and bolts can be held in the jaw and easily positioned where they are needed. Fastening on to the thread can then be done quickly and safely, thanks to the innovative special stop-plate which holds the fastener. No more time-wasting searches for dropped nuts and bolts! After applying and positioning the nut or bolt, fastening can begin immediately – no additional tools required.

2 Integrated limit-stop



Constant re-positioning of the wrench? Difficulty holding fasteners in confined spaces? Easing off to avoid any risks of injury or fastener damage? That was yesterday. Today, the Joker prevents slipping off of the fastener head with its integrated limit-stop – no longer is the thumb needed to act as a depth stop. This makes applications much easier and allows significantly more force to be applied during fastening jobs.

5 Joker Switch



The direction of the fine-tooth ratchet mechanism can easily be changed via the smooth switch lever.

6 Fine tooth mechanism



The ratcheting feature at the ring end boasts an exceptional, fine tooth mechanism – 80 teeth in all – which provides greater flexibility, even in very confined workspaces.



Joker ratcheting combination wrenches with angled ratchet head and switch lever. The metal plate in the jaw provides for the holding function which reduces the risk of losing nuts and bolts.

The low return angle of only 30° at the jaw end avoids any time-consuming flipping of the wrench when fastening. The reversible ratchet

mechanism at the ring end with its fine tothing (80 teeth) ensures great flexibility even in confined spaces.

Audibly precise ratchet mechanism. Additionally, the robust two-piece locking element provides for an extreme stability. Comes with a 15° angled ratchet end for secure work even at high torque.

3 Double-hex geometry



The Joker's clever double-hex geometry delivers a very positive connection with nuts or bolts – it's a perfect fit. And the exchangeable, hardened metal gripping plate in the Joker's mouth literally bites itself into the bolt, with its extremely hard tips. Both features combine to prevent slipping, even at higher torque.

4 Small return angle



Instead of 60°, the Joker only has a 30° return angle thanks to its unique double-hex design. Along with the Joker's straight neck, this means that flipping the wrench has become a thing of the past. With the Joker, you can now loosen and tighten nuts and bolts, in situations where conventional tools fail. Particularly in confined spaces, where conventional open-jawed wrenches cannot be used. The combination of limit stop and small return angle enables effective work, even on screw pipe connections.

7 Angled ratchet end



The ratchet end is angled at 15° to the tool axis, making application of the tool in confined spaces much easier.

8 "Take it easy" tool finder



"Take it easy" tool finder system – with profile and size colour-coding for quick and easy tool selection.

Joker 6001 – assortment

6001 Joker Switch Ratcheting combination wrenches, with switch lever

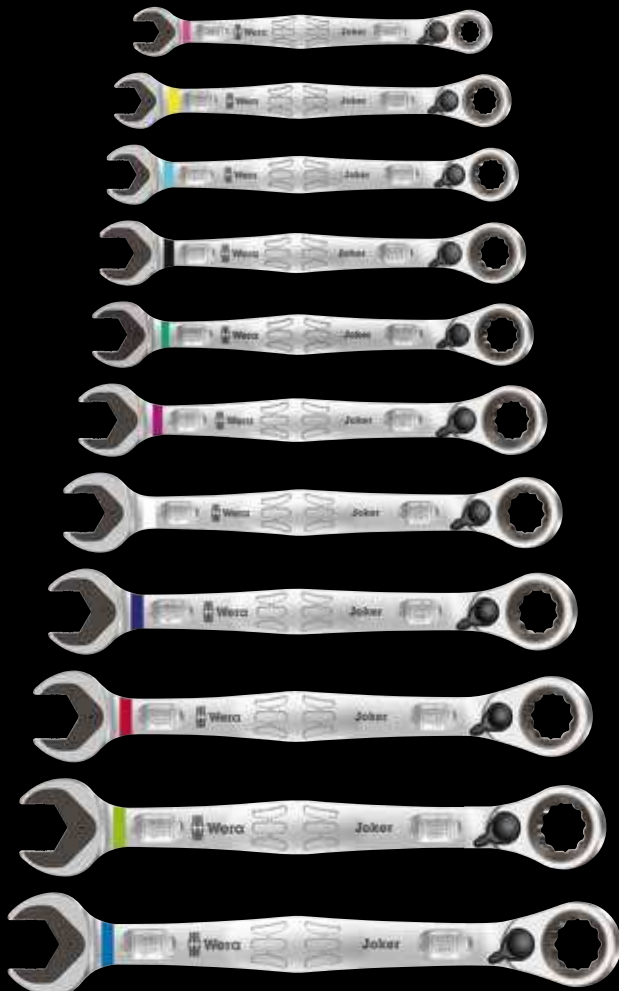

Application: Hexagonal nuts or bolts

Design: Ratcheting combination wrench, switch lever for convenient change of direction; ring end angled at 15° from the handle

		mm	mm	mm	mm	mm	mm
05020064001		8	144	20,3	5,5	18	7
05020065001		10	159	23	5,5	21,5	7,5
05020066001		11	165	24,3	6,3	22	7,5
05020067001		12	171	26,3	6,6	25	8,5
05020068001		13	179	27,3	7	26	8,5
05020069001		14	187	30	7,5	28	9,5
05020070001		15	199	32	7,8	28,8	9,5
05020071001		16	213	35	8,2	31,7	10,5
05020072001		17	225	37	8,5	33	10,5
05020073001		18	234	39,5	9	34	11
05020074001		19	246	42	9,5	34,7	11

6001 Joker Switch 4 Set 1 Set of ratcheting combination wrenches



Set of ratcheting combination wrenches, reversible

4-piece set

Durable pouch

05020090001	
6001 Joker Switch	1x 10x159; 1x 13x179; 1x 17x225; 1x 19x246

6001 Joker Switch 11 Set 1 Set of ratcheting combination wrenches



Set of ratcheting combination wrenches, reversible

11-piece set

Durable pouch

05020091001	
6001 Joker Switch	1x 8x144; 1x 10x159; 1x 11x165; 1x 12x171; 1x 13x179; 1x 14x187; 1x 15x199; 1x 16x213; 1x 17x225; 1x 18x234; 1x 19x246

6001 Joker Switch Ratcheting combination wrenches, with switch lever, Imperial



Application: Hexagonal nuts or bolts

Design: Ratcheting combination wrench, switch lever for convenient change of direction; ring end angled at 15° from the handle

		mm	mm	mm	mm	mm	mm
05020075001		5/16"	144	20,3	5,5	18	7
05020076001		3/8"	159	23	5,5	21,5	7,5
05020077001		7/16"	165	24,3	6,3	22	7,5
05020078001		1/2"	171	26,3	6,6	25	8,5
05020079001		9/16"	187	30	7,5	28	9,5
05020080001		5/8"	213	35	8,2	31,7	10,5
05020081001		11/16"	234	39,5	9	34	11
05020082001		3/4"	246	42	9,5	34,7	11

6001 Joker Switch 4 Imperial Set 1 Set of ratcheting combination wrenches, Imperial



Set of ratcheting combination wrenches, reversible

4-piece set

Durable pouch

05020092001	
Joker Switch inch	1 x 7/16"x165; 1 x 1/2"x171; 1 x 9/16"x187; 1 x 3/4"x246

6001 Joker Switch 8 Imperial Set 1 Set of ratcheting combination wrenches, Imperial



Set of ratcheting combination wrenches, reversible

8-piece set

Durable pouch

05020093001	
Joker Switch inch	1 x 5/16"x144; 1 x 3/8"x159; 1 x 7/16"x165; 1 x 1/2"x171; 1 x 9/16"x187; 1 x 5/8"x213; 1 x 11/16"x234; 1 x 3/4"x246

Joker 6000

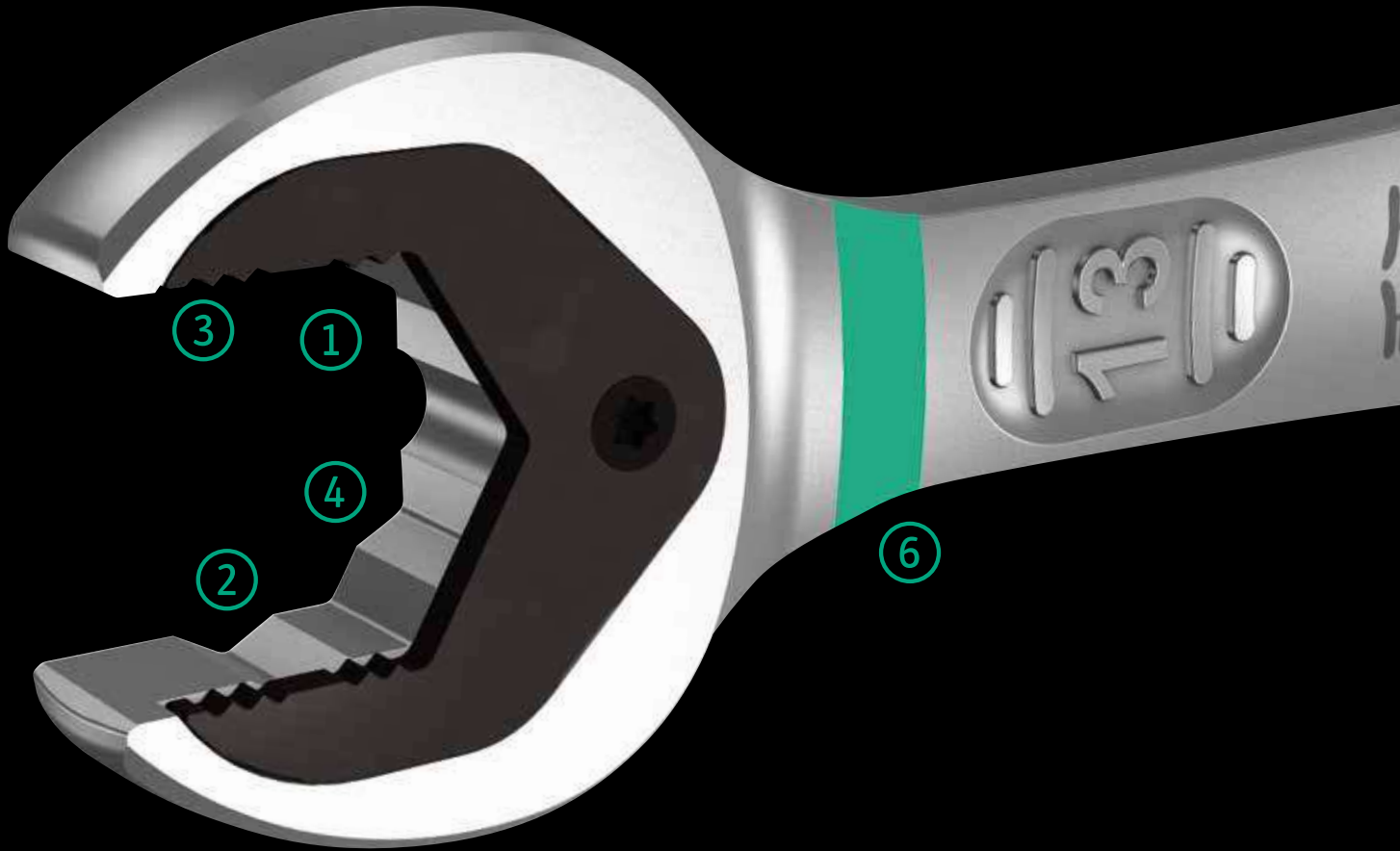

When we began to think about open-ended wrenches, we asked ourselves: why does the wrench always have to be flipped over; why does it have an offset design; why does it slip off injuring fingers?

The new design of the mouth resulted in a real Joker that works even when all other trumps have been played.

1 Holding function



The Joker's holding function means that nuts and bolts can be held in the jaw and easily positioned where they are needed. Fastening on to the thread can then be done quickly and safely, thanks to the innovative special stop-plate which holds the fastener. No more time-wasting searches

for dropped nuts and bolts! After applying and positioning the nut or bolt, fastening can begin immediately – no additional tools required.

4 Small return angle



Instead of 60°, the Joker only has a 30° return angle thanks to its unique double-hex design. Along with the Joker's straight neck, this means that flipping the wrench has become a thing of the past. With the Joker, you can now loosen and tighten nuts and bolts, in situations where conventional tools fail.



2 Integrated limit-stop



Constant re-positioning of the wrench? Difficulty holding fasteners in confined spaces? Easing off to avoid any risks of injury or fastener damage? That was yesterday. Today, the Joker prevents slipping off of the fastener head with its integrated limit-stop – no longer is the thumb needed to act as a

depth stop. This makes applications much easier and allows significantly more force to be applied during fastening jobs.

3 Double-hex geometry



The Joker's clever double-hex geometry delivers a very positive connection with nuts or bolts – it's a perfect fit. And the exchangeable, hardened metal gripping plate in the Joker's mouth literally bites itself into the bolt, with its extremely hard tips. Both features combine to prevent slipping, even at higher torque.

5 Fine tooth mechanism

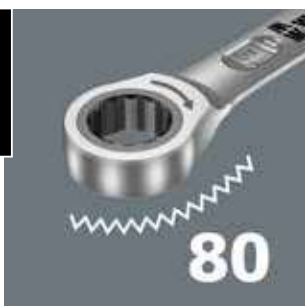

The ratcheting feature at the ring end boasts an exceptional, fine tooth mechanism – 80 teeth in all – which provides greater flexibility, even in very confined workspaces.

6 "Take it easy" tool finder



"Take it easy" tool finder system – with profile and size colour-coding for quick and easy tool selection.

Joker 6000 – assortment

6000 Joker Ratcheting combination wrenches

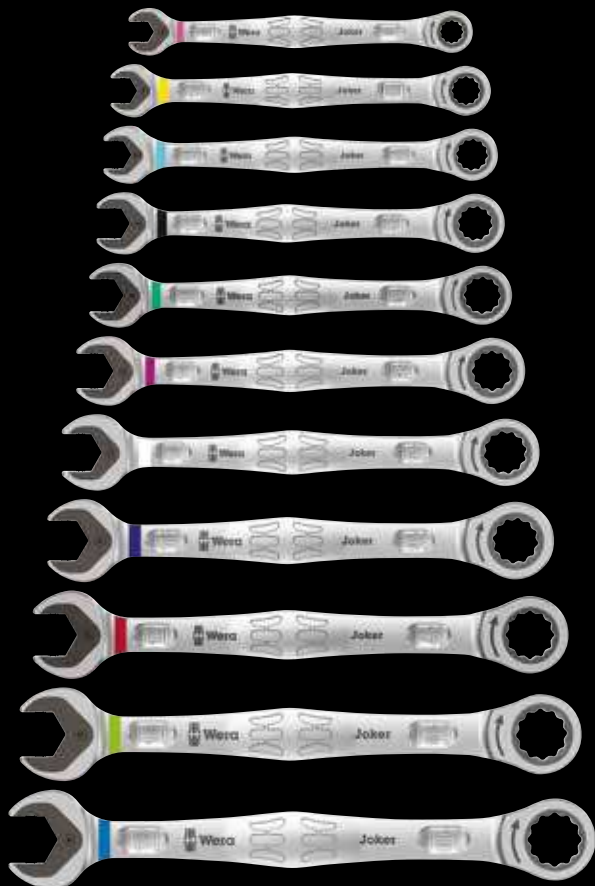

Application: Hexagonal nuts or bolts

Design: Ratcheting combination wrench

		mm	mm	mm	mm	mm	mm
05073268001		8	144	20	5,5	18	7
05073270001		10	159	22	5,5	21	7,2
05073271001		11	165	25	6,3	22	7,5
05073272001		12	170,7	26,3	6,6	25	8,5
05073273001		13	177	27,3	7	25	8,6
05073274001		14	188	29,3	7,5	28	9,2
05073275001		15	200	32,3	7,8	28,5	9,2
05073276001		16	212	35	8,2	32,7	10,5
05073277001		17	224	37,2	8,5	32,7	10,5
05073278001		18	235	39	9	33,8	11
05073279001		19	246	42	9,5	34,8	11

6000 Joker 4 Set 1 Set of ratcheting combination wrenches



Set of ratcheting combination wrenches

4-piece set

Durable pouch

05073290001	
6000 Joker	1x 10x159; 1x 13x177; 1x 17x224; 1x 19x246

6000 Joker 11 Set 1 Set of ratcheting combination wrenches



Set of ratcheting combination wrenches

11-piece set

Durable pouch

05020013001	
6000 Joker	1x 8x144; 1x 10x159; 1x 11x165; 1x 12x170,7; 1x 13x177; 1x 14x188; 1x 15x200; 1x 16x212; 1x 17x224; 1x 18x235; 1x 19x246

6000 Joker Ratcheting combination wrenches, Imperial

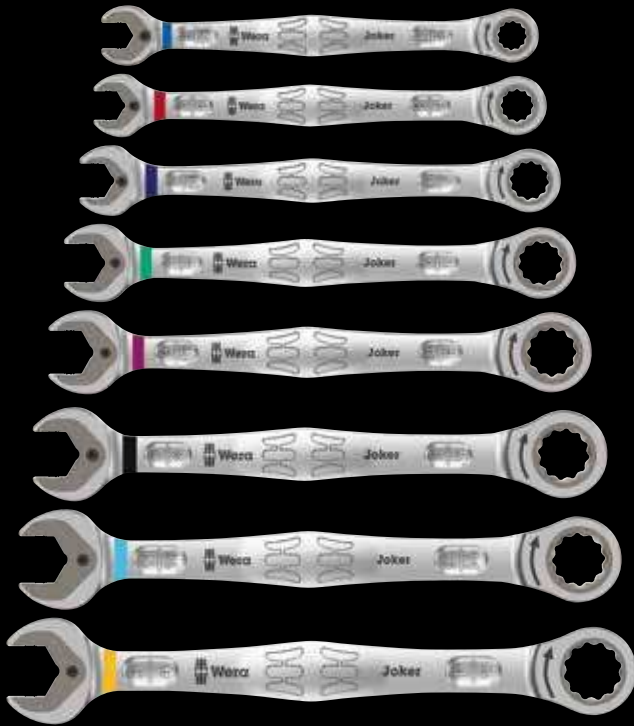

Application: Hexagonal nuts or bolts

Design: Ratcheting combination wrench

		mm	mm	mm	mm	mm	mm
05073280001		5/16"	144	20	5,5	18	7
05073281001		3/8"	159	22	5,5	21	7,2
05073282001		7/16"	165	25	6,3	22	7,5
05073283001		1/2"	177	27,3	7	25	8,6
05073284001		9/16"	188	29,3	7,5	28	9,2
05073285001		5/8"	212	35	8,2	32,7	10,5
05073286001		11/16"	235	39	9	33,8	11
05073287001		3/4"	246	42	9,5	34,8	11

6000 Joker 4 Imperial Set 1 Set of ratcheting combination wrenches, Imperial



Set of ratcheting combination wrenches
4-piece set
Durable pouch

05073295001	
6000 Joker	1 x 7/16"x165; 1 x 1/2"x177; 1 x 9/16"x188; 1 x 3/4"x246

6000 Joker 8 Imperial Set 1 Set of ratcheting combination wrenches, Imperial



Set of ratcheting combination wrenches
8-piece set
Durable pouch

05020012001	
6000 Joker	1 x 5/16"x144; 1 x 3/8"x159; 1 x 7/16"x165; 1 x 1/2"x177; 1 x 9/16"x188; 1 x 5/8"x212; 1 x 11/16"x235; 1 x 3/4"x246



Wera Werkzeuge GmbH
Korzter Straße 21-25
D-42349 Wuppertal
Germany

Phone: +49 (0)2 02/40 45-0
Fax: +49 (0)2 02/40 45 276
E-Mail: info@wera.de
www.wera.de

Wera Tools Inc. (North America)
4129 Harvester Rd, Unit H
Burlington, Ontario
Canada, L7L 5M3

Phone: 1-800-267-55 41
E-Mail: info@weratools.com
www.weratools.com

Wera Tools (UK) LTD.
Railway View
Clay Cross
Chesterfield, Derbyshire, S45 9FR

Phone: +44 (0)1246 / 277756
Fax: +44 (0)1246 / 273335
eMail: queries@wera-tools.co.uk
www.wera-tools.co.uk



EN 05 510085 001 - 0056294 - 03